



2018

VOREL 



STHOR



LUND



FLO 

FALA 



 **POWERUP**



78974

Cordless impact drill-driver

Universal, reliable and indispensable in everyday work – this is what the new Sthor impact drill-driver is like. Its strong gearbox made of steel ensures durability of the device, while its heavy duty battery provides complete freedom during work.

- 2-speed steel gearbox
- impact drilling function
- torque of 24 Nm
- 0.8-10 mm high precision drill chuck
- stepless rotational speed adjustment
- LED light illuminating the place of work
- battery with protection against overheating of cells and motor, compatible with other 18 V Sthor devices
- the set includes a case and accessories made of CrV steel

Akumulatorowa wiertarko-wkrętarka udarowa

Uniwersalna, niezawodna i niezbędna w codziennej pracy – taka jest nowa wiertarko-wkrętarka udarowa Sthor. Mocna, stalowa przekładnia gwarantuje trwałość urządzenia, a wytrzymała bateria zapewnia pełną swobodę podczas pracy.

- 2-biegowa stalowa przekładnia
- funkcja wiercenia z udarem
- moment obrotowy 24 Nm
- precyzyjny uchwyt wiertarski 0,8-10 mm
- bezstopniowa regulacja prędkości obrotowej
- lampka LED oświetlająca miejsce pracy
- bateria z zabezpieczeniem przed przegrzaniem ogniw i silnika, kompatybilna z innymi urządzeniami Sthor 18 V
- w zestawie z walizką i akcesoriami ze stali CrV

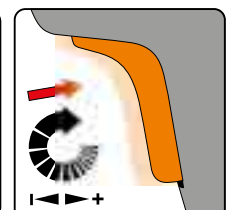
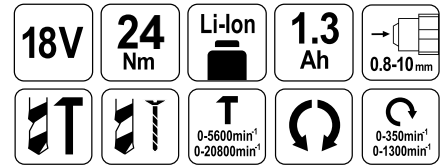

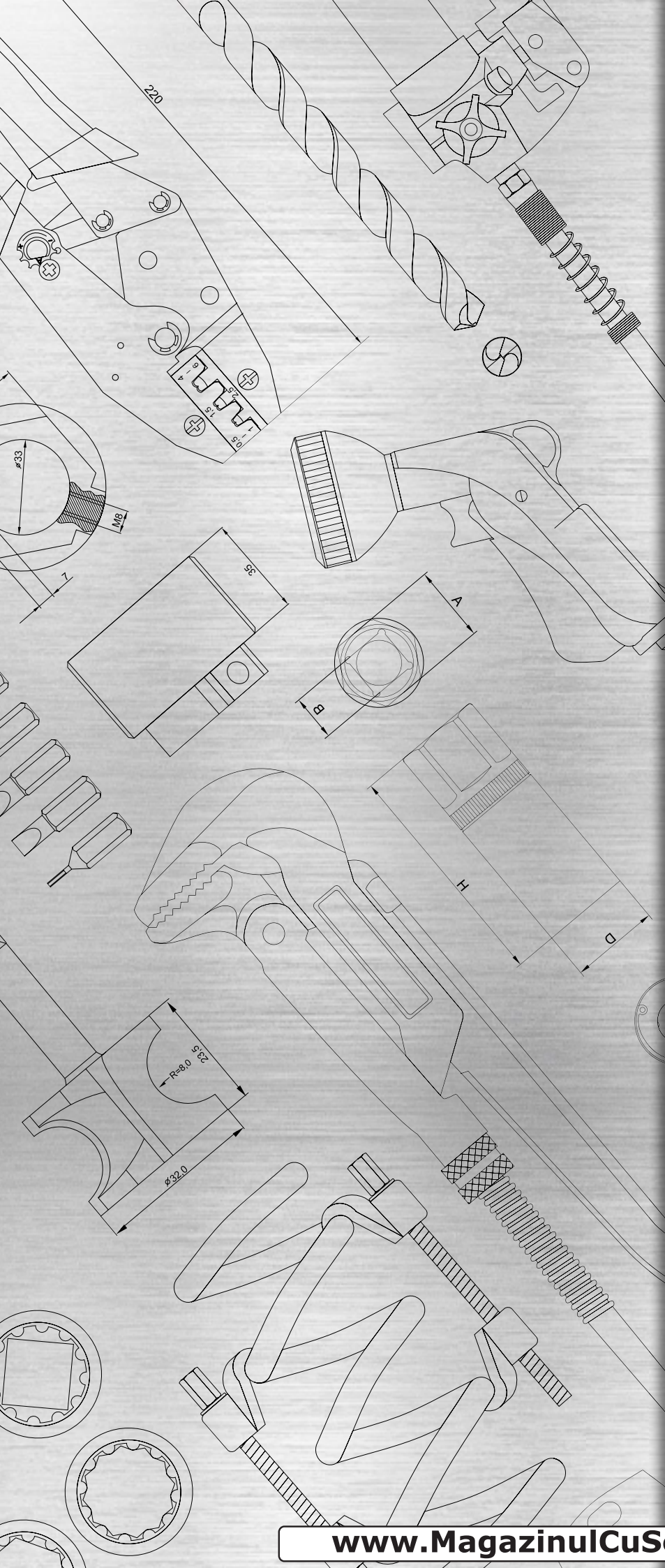

TOYA SA
ul. Soltysowicka 13-15
51-168 Wrocław
☎ (+48 71) 32 46 200
fax: (+48 71) 32 46 370

sales@yato.pl (sale)
export@yato.pl (export)
import@yato.pl (import)

ODDZIAŁ WARSZAWSKI
Teren ProLogis Park Nadarzyn
al. Kasztanowa 160
05-831 Młochów k. Warszawy

☎ (+48 22) 73 82 800
☎ (+48 22) 73 82 828
sales@yato.pl (sale)
export@yato.pl (export)

1 Spanners
Klucze

6-13



2 Sockets, accessories & sets
Klucze nasadowe, akcesoria i zestawy

14-25



3 Screwdrivers & screwdriver bits
Wkrętaki i końcówki wkrętakowe

26-43



4 Pliers & pipe wrenches
Szczypce i klucze do rur

44-53



5 Electrician tools
Narzędzia dla elektryków

54-57



6 Hammers, chisels, punches & axes
Młotki, dłuta, przecinaki i siekiery

58-67



7 Clamps & vices
Ściski i imadła

68-73



8 Cutting tools
Narzędzia tnące

74-111



9	Hydraulic tools Narzędzia hydrauliczne	112-119
		
10	Fastening tools Narzędzia do łączenia	120-133
		
11	Plastering & bricklaying tools Narzędzia budowlane i malarskie	134-163
		
12	Measuring tools Narzędzia miernicze	164-173
		
13	Pneumatic tools Narzędzia pneumatyczne	174-185
		
14	Special automotive tools & equipment Narzędzia i wyposażenie warsztatu samochodowego	186-209
		
15	Power tools & accessories Elektronarzędzia i akcesoria	210-245
		
16	Welding equipment Sprzęt spawalniczy	246-255
		

17 Safes, padlocks & locks 256-267
Sejfy, kłódki i zamki



18 Tool bags & boxes 268-273
Torby i skrzynki narzędziowe



19 Bicycle accessories 274-281
Akcesoria rowerowe



20 Household equipment 282-307
Gospodarstwo domowe

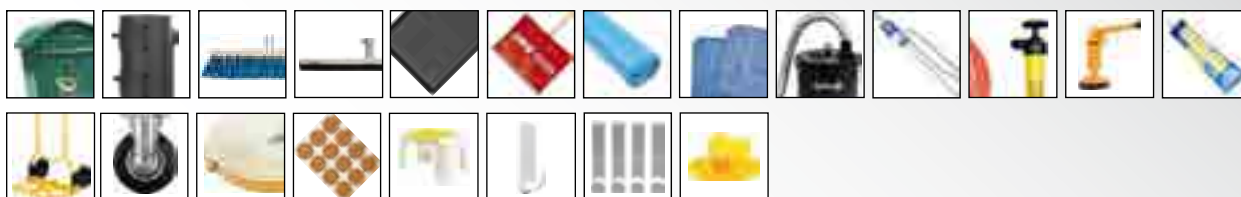

21 Health & safety products 308-323
Artykuły BHP

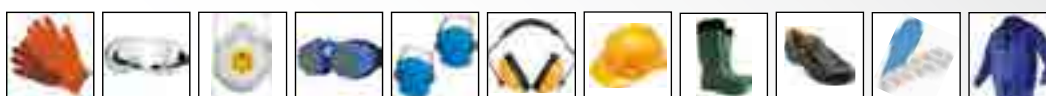

22 Electric products 324-335
Artykuły elektryczne



23 Garden tools & power tools 336-391
Narzędzia i elektronarzędzia ogrodowe



24 Sanitary ware & hydraulics
Armatura sanitarna i hydraulika

392-419



Memo

1

Spanners
Klucze



Combination spanners Klucze płasko-oczkowe

8-9



Combination spanners & sets, polished head

Klucze płasko-oczkowe i zestawy,
polerowana główka.....

8

Combination spanners & sets, satin finish CrV

Klucze płasko-oczkowe i zestawy,
wykończenie satynowe CrV.....

9

Combination ratchet wrenches Klucze płasko-oczkowe z grzechotką

10



Combination ratchet wrenches

Klucze płasko-oczkowe z grzechotką.....

10

Combination ratchet wrench sets

Zestawy kluczy płasko-oczkowych z grzechotką.....

10

Double open end spanners Klucze płaskie

10



Double open end spanners & sets, polished head

Klucze płaskie i zestawy, polerowana główka.....

10

Double open end spanner sets, satin finish CrV

Zestawy kluczy płaskich,
wykończenie satynowe CrV.....

10

Bi-hexagonal ring spanners Klucze oczkowe odgięte

11



Bi-hexagonal ring spanners & sets, polished head

Klucze oczkowe odgięte i zestawy,
polerowana główka.....

11

Open end swivel socket spanners & sets Klucze płasko-nasadowe i zestawy

11



T-type deep socket wrenches Klucze nasadowe typu „T”

12



Box end wrenches Klucze rurowe

12



L-type wrenches

Klucze nasadowe typu „L”

12



Multipipe wrenches

Klucze uniwersalne

12



Double socket ratchet handles

Dwustronne klucze nasadkowe z grzechotką

12



Adjustable wrenches

Klucze nastawne

13



Torque wrenches

Klucze dynamometryczne

13



1

PL Klucz plasko-oczkowy CZ Plochý a očkový klíč
 GB Combination spanner RO Cheie combinata
 D Maulringschlüssel H Kulcskészlet villás-csillag
 RUS Набор комбинированных ключей E Combinada con llave de estrella



No.	mm	pcs	Icon
51060	6	200/1200	
51070	7	200/1000	
51080	8	100/600	
51090	9	50/600	
51100	10	50/600	
51110	11	50/400	
51120	12	50/400	
51130	13	50/400	
51140	14	50/300	
51150	15	50/300	
51160	16	50/200	
51170	17	20/200	
51180	18	25/200	
51190	19	30/120	
51200	20	20/160	
51210	21	20/120	
51220	22	30/120	
51240	24	15/90	
51270	27	15/60	
51300	30	10/40	
51320	32	10/40	

PL Komplet kluczy plasko-oczkowych CZ Souprava plochých a očkových klíčů
 GB Combination spanner set RO Set chei combinata
 D Maulringschlüsselsatz H Kulcskészlet villás-csillag clip
 RUS Набор комбинированных ключей E Juego de combinadas con llave de estrella



No.	mm	pcs	Icon
50850	8: 10: 12: 13: 14: 17	6	4/40
50861	6: 8: 10: 13: 14: 17: 19: 22	8	4/32
50871	6: 7: 8: 9: 10: 11: 12: 13: 14: 17: 19: 22	12	2/20

PL Komplet kluczy plasko-oczkowych CZ Souprava plochých a očkových klíčů
 GB Combination spanner set RO Set chei combinata
 D Maulringschlüsselsatz H Kulcskészlet villás-csillag clip
 RUS Набор комбинированных ключей E Juego de combinadas con llave de estrella



No.	mm	pcs	Icon
51560	8: 10: 12: 13: 14: 17	6	15/60
51590	6: 8: 10: 12: 13: 14: 17: 19	8	10/40
51630	6: 7: 8: 9: 10: 11: 12: 13: 14: 17: 19: 22	12	5/20
51640	6: 7: 8: 9: 10: 11: 12: 13: 14: 17: 19: 21: 24: 27: 32	15	2/12
51645	6: 7: 8: 9: 10: 11: 12: 13: 14: 15: 16: 17: 18: 19: 21: 22: 24: 27: 30: 32	20	8

PL Komplet kluczy plasko-oczkowych CZ Souprava plochých a očkových klíčů
 GB Combination spanner set RO Set chei combinata
 D Maulringschlüsselsatz H Kulcskészlet villás-csillag clip
 RUS Набор комбинированных ключей E Juego de combinadas con llave de estrella



No.	mm	pcs	Icon
51580	6: 8: 10: 11: 13: 14: 17: 19	8	5/50
51620	6: 7: 8: 9: 10: 11: 12: 13: 14: 17: 19: 22	12	5/20
51650	6: 7: 8: 9: 10: 11: 12: 13: 14: 15: 16: 17: 18: 19: 20: 21: 22: 23: 24: 25: 26: 27: 28: 30: 32	25	4

PL Komplet kluczy plasko-oczkowych CZ Souprava plochých a očkových klíčů
 GB Combination spanner set RO Set chei combinata
 D Maulringschlüsselsatz H Kulcskészlet villás-csillag clip
 RUS Набор комбинированных ключей E Juego de combinadas con llave de estrella



No.	size / rozmiar	pcs	Icon
50880	1/4" (6.3 mm); 5/16" (7.9 mm); 3/8" (9.5 mm); 7/16" (11.1 mm); 1/2" (12.7 mm); 9/16" (14.3 mm); 5/8" (15.9 mm); 11/16" (17.5 mm); 3/4" (19.0 mm)	9	10

PL Klucz plasko-oczkowy
GB Combination spanner
D Maulringschlüssel
RUS Ключ комбинированный

CZ Plochý a očkový klíč
RO Cheie combinata
H Kulcs villás-csillag
E Combinada con llave de estrella



No.	mm	
51671	6	20/400
51672	7	20/400
51673	8	20/400
51674	9	20/400
51675	10	20/320
51676	11	20/240
51677	12	20/240
51678	13	20/200
51679	14	20/200
51680	15	20/200
51681	16	20/200
51682	17	20/160
51683	18	20/160
51684	19	20/160
51685	20	20/120
51686	21	20/120
51687	22	20/120
51688	23	10/80
51689	24	10/80
51690	25	10/60
51691	26	10/40
51692	27	10/40
51693	28	10/40
51694	29	10/40
51695	30	10/40
51696	32	10/40

PL Komplet kluczy plasko-oczkowych
GB Combination spanner set
D Maulringschlüsselsatz
RUS Набор комбинированных ключей

CZ Souprava plochých a očkových klíčů
RO Set chei combinata
H Kulcskészlet villás-csillag
E Juego de combinadas con llave de estrella

12
PCS

CrV



No.	mm	pcs	
51710	6: 8: 10: 11: 12: 13: 14: 15: 17: 18: 19: 22	12	20

PL Komplet kluczy plasko-oczkowych
GB Combination spanner set
D Maulringschlüsselsatz
RUS Набор комбинированных ключей

CZ Souprava plochých a očkových klíčů
RO Set chei combinata
H Kulcskészlet villás-csillag clip
E Juego de combinadas con llave de estrella

CrV



No.	mm	pcs	
51720	8: 10: 12: 13: 14: 17	6	4/40
51721	6: 8: 10: 12: 13: 14: 17: 19	8	4/32
51722	6: 7: 8: 9: 10: 11: 12: 13: 14: 17: 19: 22	12	2/20

PL Komplet kluczy plasko-oczkowych
GB Combination spanner set
D Maulringschlüsselsatz
RUS Набор комбинированных ключей

CZ Souprava plochých a očkových klíčů
RO Set chei combinata
H Kulcskészlet villás-csillag
E Juego de combinadas con llave de estrella

8
PCS

CrV



No.	mm	pcs	
51705	8: 10: 12: 13: 14: 15: 17: 19	8	30

PL Komplet kluczy plasko-oczkowych
GB Combination spanner set
D Maulringschlüsselsatz
RUS Набор комбинированных ключей

CZ Souprava plochých a očkových klíčů
RO Set chei combinata
H Kulcskészlet villás-csillag
E Juego de combinadas con llave de estrella

25
PCS

CrV

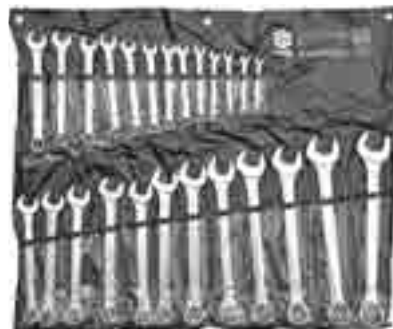

No.	mm	pcs	
51715	6: 7: 8: 9: 10: 11: 12: 13: 14: 15: 16: 17: 18: 19: 20: 21: 22: 23: 24: 25: 26: 27: 28: 30: 32	25	4

1

- PL Klucz płasko-oczkowy z grzechotką
- GB Combination ratchet wrench
- D Ratschenringmaulschlüssel
- RUS Ключ комбинированный с трещоткой
- CZ Klíč oškorplochý ráčnový
- RO Cheie combinata cu crichet
- H Csillag-villás kulcs racsnis
- E Llave combinada fija abierta y carraca



No.	mm	
52652	10	10/100
52653	11	10/100
52654	12	10/100
52655	13	10/100
52656	14	10/100
52657	15	10/100
52658	17	10/50
52659	19	10/50
52660	22	10/40

- PL Klucz płaski
- GB Double open end spanner
- D Doppelmaulschlüssel
- RUS Ключ рожковый
- CZ Plochý klíč
- RO Cheie fixa
- H Villáskulcs
- E Llave fija



No.	mm	
50070	6x7	100/1000
50090	8x9	60/600
50100	8x10	60/600
50110	10x11	60/600
50120	10x13	50/500
50130	12x13	50/500
50150	14x15	50/300
50170	13x17	50/300
50190	17x19	30/180
50220	19x22	30/180
50270	24x27	25/100
50330	30x32	15/60

- PL Komplet kluczy płaskich
- GB Double open end spanner set
- D Doppelmaulschlüsselsatz
- RUS Набор ключей рожковых
- CZ Souprava plochých klíčů
- RO Set chei fixe
- H Kulcskészlet, villás
- E Juego de llaves fijas



No.	mm	pcs	
50580	6x7; 8x9; 10x11; 12x13; 14x15; 16x17; 18x19; 20x22	8	10/40
50620	6x7; 8x9; 10x11; 12x13; 14x15; 16x17; 18x19; 20x22; 21x23; 24x26; 25x28; 27x32	12	5/15

- PL Zestaw kluczy płasko-oczkowych z grzechotką
- GB Combination ratchet wrench set
- D Ratschenringmaulschlüssel-Satz
- RUS Набор комбинированных ключей с трещоткой
- CZ Klíče ráčnové sada
- RO Set chei combinata
- H Racsnis csillag-villás kulcs készlet
- E Juego de llaves planas con matraca



No.	mm	pcs	
52661	10; 13; 17; 19	4	10/20

- PL Komplet kluczy płaskich
- GB Double open end spanner set
- D Doppelmaulschlüsselsatz
- RUS Набор ключей рожковых
- CZ Souprava plochých klíčů
- RO Set chei fixe
- H Kulcskészlet, villás
- E Juego de llaves fijas



No.	mm	pcs	
50560	6x7; 8x9; 10x11; 12x13; 14x15; 16x17	6	20/80
50590	6x7; 8x9; 10x11; 12x13; 14x15; 16x17; 18x19; 20x22	8	10/40
50610	6x7; 8x9; 10x11; 12x13; 14x15; 16x17; 18x19; 20x22; 24x27; 30x32	10	5/20
50630	6x7; 8x9; 10x11; 12x13; 14x15; 16x17; 18x19; 20x22; 21x23; 24x26; 25x28; 27x32	12	5/15

- PL Komplet kluczy płaskich
- GB Double open end spanner set
- D Doppelmaulschlüsselsatz
- RUS Набор ключей рожковых
- CZ Souprava plochých klíčů
- RO Set chei fixe
- H Kulcskészlet, villás
- E Juego de llaves fijas



No.	mm	pcs	
51740	6x7; 8x9; 10x11; 12x13; 14x15; 16x17	6	4/40
51741	6x7; 8x9; 10x11; 12x13; 14x15; 16x17; 18x19; 20x22	8	4/24

PL Klucz oczkowy odgięty
GB Bi-hexagonal ring spanner
D Doppelringschlüssel
RUS Ключ накидной изогнутый

CZ Očkový klíč ohnutý
RO Cheie inelaro-curbată
H Hajlítótszárú csillagkulcs
E Llave de estrella



No.	mm	
52100	8x10	50/300
52120	10x13	50/200
52130	12x13	50/200
52170	13x17	30/120
52190	17x19	25/100
52220	19x22	20/80
52240	22x24	10/60
52270	24x27	10/60
52340	30x32	5/40

PL Klucz płasko-nasadowy, przegubowy
GB Open end swivel head socket wrench
D Maul-Steckschlüssel
RUS Ключ рожково-торцевой с шарниром

CZ Klic nasad. ploch.
RO Chei fixe-tubulare
H Kulcs villás-dugó
E Combinada con vaso



No.	mm	
52680	8	20/200
52700	10	20/200
52710	11	20/200
52720	12	20/200
52730	13	20/200
52740	14	20/200
52750	15	25/100
52770	17	25/100
52790	19	25/50
52820	22	25/50

PL Klucz płasko-nasadowy, przegubowy
GB Open end swivel head socket wrench
D Maul-Steckschlüssel
RUS Ключ рожково-торцевой с шарниром

CZ Klic nasad. ploch.
RO Chei fixe-tubulare
H Kulcs villás-dugó
E Combinada con vaso

CrV
40



VOREL

No.	mm	pcs packing	
52840	8	10	200
52841	10	10	200
52842	11	10	160
52843	12	10	160
52844	13	10	160
52845	14	10	160
52846	17	10	100

PL Komplet kluczy oczkowych odgiętych
GB Bi-hexagonal ring spanner set
D Doppelringschlüsselsatz
RUS Набор ключей накидных изогнутых

CZ Klíče očkové vyhnuté sada
RO Set chei inelare cu cot
H Csillagkulcs készlet
E Juego de llaves de estrella acodadas

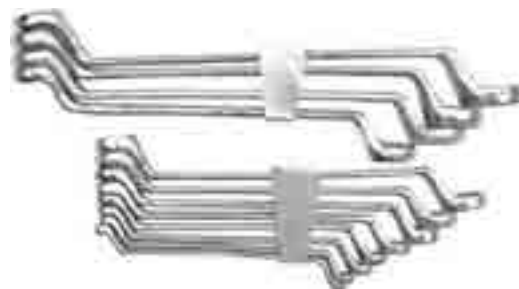

No.	mm	pcs	
52560	6x7; 8x9; 10x11; 12x13; 14x15; 16x17	6	6/36
52570	6x7; 8x9; 10x11; 12x13; 14x15; 16x17; 18x19; 20x22	8	5/20
52630	6x7; 8x9; 10x11; 12x13; 14x15; 16x17; 18x19; 20x21; 22x23; 24x25; 26x27; 28x32	12	2/8

PL Komplet kluczy oczkowych odgiętych
GB Bi-hexagonal ring spanner set
D Doppelringschlüsselsatz
RUS Набор ключей накидных изогнутых

CZ Klíče očkové vyhnuté sada
RO Set chei inelare cu cot
H Csillagkulcs készlet
E Juego de llaves de estrella acodadas

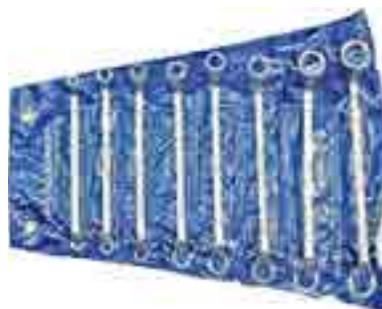

No.	mm	pcs	
52580	6x7; 8x9; 10x11; 12x13; 14x15; 16x17; 18x19; 20x22	8	5/20

PL Komplet kluczy płasko-nasadowych
GB Open end swivel head socket wrench set
D Gabel-Gelenk-Steckschlüsselsatz
RUS Набор ключей рожково-торцевых с шарниром
CZ Ploché nástrčné klíče kloubové
RO Chei plato-tubulare cu articulație
H Kulcs villás-csuklós dugó
E Combinadas con vaso articulado

6
PCS



No.	mm	pcs	
52860	10; 11; 13; 14; 17; 19	6	6/24

1

- PL Klucz nasadowy typu „T”
 GB T-type socket wrench
 D T-Griff-Steckschlüssel
 RUS Ключ торцевой Т-образный
- CZ Čepový a nastrčný klíč
 RO Cheie tubulara tip „T”
 H Kulcs, csap-dugó
 E Llave mandril vaso



No.	L (mm)	mm	
56710	380	8	50
56720	380	10	50
56730	380	13	50
56740	380	17	50
56750	380	19	50
56770	190	8	50
56780	190	10	50
56790	190	13	50

- PL Klucz nasadowy typu „L”
 GB L-type socket wrench
 D Steckschlüssel gebogen
 RUS Ключ торцевой L-типа
- CZ Nástrčný klíč fajfkový
 RO Cheie tubulara cu cot tip „L”
 H Kulcs, dugó-pipa
 E Llave de vaso „L”



No.	mm	
54600	6	20/240
54610	7	20/240
54620	8	20/240
54630	9	20/240
54640	10	20/240
54650	11	20/200
54660	12	20/200
54670	13	20/200
54680	14	10/100
54690	15	10/100
54700	16	10/100
54710	17	10/80
54720	18	10/80
54730	19	10/80
54750	21	10/60
54760	22	10/60
54780	24	10/40

- PL Komplet kluczy rurowych
 GB Tubular socket wrench set
 D Rohrsteckschlüsselsatz
 RUS Набор ключей трубчатых
- CZ Klíče trubkové
 RO Chei pt. țevi
 H Csőkulcs
 E Llaves de tuberia

10
PCS



No.	mm	pcs	
52900	6-22	10	6/24

- PL Klucze uniwersalne
 GB Multipipe wrenches
 D Universalschlüssel
 RUS Ключи универсальные
- CZ Univerzální klíče
 RO Chei universale
 H Univerzális kulcs
 E Juego de llaves universales



VOREL

No.	mm	pcs	
54000	9-32	2	20/40

- PL Klucze rurowe
 GB Double ratchet wrench
 D Gerüstratsche
 RUS Ключ торцевой с трещоткой
- CZ Ráčňový klíč průchozí dvoustranný
 RO Cheie tubulara dubla cu clichet
 H Kettős racsnis kulcs
 E Llave de vaso con carraca

32T



VOREL

No.	mm	
52933	14x17	2/40
52935	17x19	2/40
52936	19x22	2/40

PL Klucz nastawny CZ Nastawitelny klic
 GB Adjustable wrench RO Cheie reglabila
 D Rollgabelschlüssel H Állítható
 RUS Ключ разводной E Llave ajustable



No.	L (mm)	
54061	200	6/60
54062	250	6/36
54063	300	6/24

PL Klucz nastawny CZ Nastawitelny klic
 GB Adjustable wrench RO Cheie reglabila
 D Rollgabelschlüssel H Állítható
 RUS Ключ разводной E Llave ajustable



No.	L (mm)	
54070	150	6/120
54071	200	6/60
54072	250	6/36
54073	300	6/24

PL Klucz dynamometryczny wychylny
 GB Torque wrench
 D Drehmomentschlüssel
 RUS Ключ динамометрический стрелочный
 CZ Dynamometrický klic
 RO Cheie cu dinamometru
 H Nyomatékkulcs
 E Llave dinamometrico inclin.



No.	size / rozmiar	
57451	1/2" (12.7 mm)	16

PL Klucz nastawny CZ Nastawitelny klic
 GB Adjustable wrench RO Cheie reglabila
 D Rollgabelschlüssel H Állítható
 RUS Ключ разводной E Llave ajustable



No.	L (mm)	packing	
54065	150	6/120	
54066	200	6/60	
54067	250	6/36	
54068	300	6/24	
54080	375	6/12	
54081	450	6	

PL Klucz dynamometryczny wychylny
 GB Torque wrench
 D Drehmomentschlüssel
 RUS Ключ динамометрический стрелочный
 CZ Dynamometrický klic
 RO Cheie cu dinamometru
 H Nyomatékkulcs
 E Llave dinamometrico inclin.

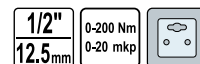

No.	size / rozmiar	
57450	1/2" (12.7 mm)	6/24

PL Klucz dynamometryczny CZ Dynamometrický klic
 GB Torque wrench RO Cheie cu dinamometru
 D Drehmomentschlüssel H Nyomatékkulcs
 RUS Ключ динамометрический E Llave dinamometrico



No.	size / rozmiar	L (mm)	Nm	packing	
57300	3/8" (9.5 mm)	270	13.6 - 108	20	
57350	1/2" (12.7 mm)	465	28.0 - 210	10	
57400	3/4" (19.0 mm)	625	68.0 - 406	10	

2

Sockets, accessories & sets Klucze nasadowe, akcesoria i zestawy



Sockets**Klucze nasadowe**

16

**Hexagonal sockets 1/2"**

Klucze nasadowe sześciokątne 1/2"..... 16

Hexagonal sockets 3/4"

Klucze nasadowe sześciokątne 3/4"..... 16

Universal wrench sockets

Nasadki uniwersalne..... 16

Accessories**Akcesoria**

16-17

**Extension bars**

Przedłużki..... 16

Adapters

Redukcje..... 16

Universal joints

Przeguby Cardana..... 16

Sliding T-bars

Pokręta typu „T”..... 17

Speed braces

Rękojeści wygięte..... 17

Ratchet handles**Grzechotki**

17

**Socket & tool sets****Zestawy kluczy nasadowych i narzędziowych**

18-24

**Socket sets 1/4"**

Zestawy kluczy nasadowych 1/4"..... 18

Socket sets 3/8"

Zestawy kluczy nasadowych 3/8"..... 18

Socket sets 1/2"

Zestawy kluczy nasadowych 1/2"..... 18

Socket sets 3/4"

Zestawy kluczy nasadowych 3/4"..... 19

Tool sets

Zestawy narzędziowe..... 19

2

PL Nasadka sześciokątna
GB Hexagonal socket
D Sechskantenschlüssel
RUS Торцевая головка 6-гранная

CZ Šestihřanný nástavec
RO Cheie tubulară hexagonală
H Hatszögű rátét
E Boquilla hexagonal corta

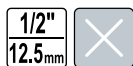

No.	mm	size / rozmiar	
53080	8	1/2" (12.7 mm)	150/300
53100	10	1/2" (12.7 mm)	150/300
53120	12	1/2" (12.7 mm)	150/300
53130	13	1/2" (12.7 mm)	150/300
53140	14	1/2" (12.7 mm)	150/300
53150	15	1/2" (12.7 mm)	150/300
53160	16	1/2" (12.7 mm)	150/300
53170	17	1/2" (12.7 mm)	125/250
53180	18	1/2" (12.7 mm)	100/200
53190	19	1/2" (12.7 mm)	100/200
53210	21	1/2" (12.7 mm)	75/150
53220	22	1/2" (12.7 mm)	75/150
53240	24	1/2" (12.7 mm)	50/100
53270	27	1/2" (12.7 mm)	50/100
53300	30	1/2" (12.7 mm)	40/80
53320	32	1/2" (12.7 mm)	40/80

PL Nasadka uniwersalna
GB Universal wrench socket
D Universal Steckschlüssel
RUS Головка универсальная

CZ Univerzální šroubovací nástavec
RO Cheie tubulara universala
H Univerzális dugókulcs
E Universal llave de cubo



No.	mm	size / rozmiar	
53002	7-19	3/8" (9.5 mm)	8/48
53003	11-32	1/2" (12.7 mm)	6/24

PL Redukcja
GB Adapter
D Reduktion
RUS Переходник

CZ Redukce
RO Reducție
H Redukció
E Reducció



No.	size / rozmiar	
53760	3/8" (9.5 mm) - 1/4" (6.3 mm)	120/240

PL Nasadka sześciokątna
GB Hexagonal socket
D Sechskantenschlüssel
RUS Торцевая головка 6-гранная

CZ Šestihřanný nástavec
RO Cheie tubulară hexagonală
H Hatszögű rátét
E Boquilla hexagonal corta

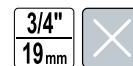

No.	mm	size / rozmiar	
53400	22	3/4" (19.0 mm)	50
53410	24	3/4" (19.0 mm)	50
53420	27	3/4" (19.0 mm)	50
53430	30	3/4" (19.0 mm)	50
53440	32	3/4" (19.0 mm)	50
53450	36	3/4" (19.0 mm)	50
53460	38	3/4" (19.0 mm)	40
53470	41	3/4" (19.0 mm)	25
53480	46	3/4" (19.0 mm)	20
53490	50	3/4" (19.0 mm)	20

PL Przedłużka
GB Extension bar
D Verlängerung
RUS Удлинитель для воротка

CZ Prodlužovací přípravek
RO Prelungitor
H Hosszabbító
E Tubo de prolongación



No.	size / rozmiar	L (mm)	
53610	1/2" (12.7 mm)	125	50/100
53630	1/2" (12.7 mm)	250	25/50



No.	size / rozmiar	L (mm)	
53650	3/4" (19.0 mm)	100	60
53670	3/4" (19.0 mm)	200	25

PL Przegub Cardana
GB Universal joint
D Kardangelen
RUS Карданный шарнир

CZ Kardanový kloub
RO Articulație Cardanică
H Kardán csukló
E Articulación Cardan



No.	size / rozmiar	
53598	1/4" (6.3 mm)	150/300
53599	3/8" (9.5 mm)	100/200
53600	1/2" (12.7 mm)	60/120

PL Pokrętko typu „T”
GB Sliding t-bar
D Handgriff mit Gleitstück
RUS Вороток для торцевых головок T-образный

CZ Otočná ráčká typ „T”
RO Măner clupă tipul „T”
H „T” alakú hajtókar
E Mango tipo „T”



No.	size / rozmiar	L (mm)	
53700	1/2" (12.7 mm)	250	25/50



No.	size / rozmiar	L (mm)	
53710	3/4" (19.0 mm)	450	20

PL Grzechotka
GB Ratchet handle
D Hebelumschaltknarre
RUS Трещотка для торцевых головок

CZ Řehtačka
RO Antrenor cu clichet
H Racsni
E Llave de carraca



No.	size / rozmiar	L (mm)	
53500	1/4" (6.3 mm)	125	40/80
53520	3/8" (9.5 mm)	195	25/50
53540	1/2" (12.7 mm)	250	20/40

PL Grzechotka przegubowa
GB Flexible ratchet handle
D Gelenk-Hebelumschaltknarre
RUS Трещотка шарнирная

CZ Kloubová řehtačka
RO Antrenor cu clichet, flexibil
H Csuklós racsni
E Llave de carraca articulada

1/2"
12.5mm



No.	size / rozmiar	L (mm)	
53560	1/2" (12.7 mm)	250	25/50

PL Grzechotka
GB Ratchet handle
D Hebelumschaltknarre
RUS Трещотка с пластиковым покрытием

CZ Řehtačka
RO Antrenor cu clichet
H Racsni
E Llave de carraca

CrV



No.	size / rozmiar	L (mm)	teeth / zęby	
53575	1/4" (6.3 mm)	155	72	12/72
53576	3/8" (9.5 mm)	200	72	6/48
53577	1/2" (12.7 mm)	250	72	6/36

PL Rękojeść wygięta
GB Speed brace
D Kurbelverlängerung
RUS Вороток-колесорот

CZ Ohnutá rukojeť
RO Măner curbat (manivelă)
H Hajlított markolat /korba/
E Mango encorvado /manivela/



No.	size / rozmiar	L (mm)	
53730	1/2" (12.7 mm)	400	40

PL Grzechotka
GB Ratchet handle
D Hebelumschaltknarre
RUS Трещотка для торцевых головок

CZ Řehtačka
RO Antrenor cu clichet
H Racsni
E Llave de carraca



No.	size / rozmiar	L (mm)	
53561	1/4" (6.3 mm)	135	40/80
53562	3/8" (9.5 mm)	190	25/50
53563	1/2" (12.7 mm)	240	20/40

PL Grzechotka
GB Ratchet handle
D Hebelumschaltknarre
RUS Трещотка с изогнутой ручкой

CZ Řehtačka
RO Antrenor cu clichet
H Racsni
E Llave de carraca

CrV

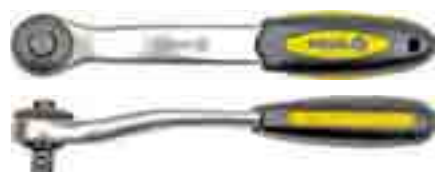

No.	size / rozmiar	L (mm)	teeth / zęby	
53571	1/4" (6.3 mm)	150	72	6/36
53572	3/8" (9.5 mm)	200	72	6/36
53573	1/2" (12.7 mm)	260	72	6/36

PL Grzechotka
GB Ratchet handle
D Hebelumschaltknarre
RUS Трещотка для торцевых головок

CZ Řehtačka
RO Antrenor cu clichet
H Racsni
E Llave de carraca

3/4"
19mm

500mm



No.	size / rozmiar	L (mm)	
53580	3/4" (19.0 mm)	500	10

PL Komplet nasadek z akcesoriami
 GB Socket set
 D Sechskantenschlüssel-Einsatz
 RUS Набор торцевых головок

CZ Sada nástrčných klíčů a ráčny
 RO Trusă chei tubulare cu antrenor
 H Dugókulcs készlet racsnis hajtókarral
 E Juego de boquillas con accesorios

16
PCS



① 1/4" (6.3 mm) x 120 mm;
 ② 1/4" (6.3 mm) x 50 mm;
 ③ 1/4" (6.3 mm): 4, 4.5, 5, 5.5, 6, 6.5, 7, 8, 9, 10, 11, 12, 13 mm;
 ④ 1/4" (6.3 mm)

No.	pcs	☐
58160	16	20

PL Komplet nasadek z akcesoriami
 GB Socket set
 D Sechskantenschlüssel-Einsatz
 RUS Набор торцевых головок

CZ Sada nástrčných klíčů a ráčny
 RO Trusă chei tubulare cu antrenor
 H Dugókulcs készlet racsnis hajtókarral
 E Juego de boquillas con accesorios

24
PCS



① 1/2" (12.7 mm); ② 1/2" (12.7 mm) x 240 mm; ③ 1/2" (12.7 mm): 8, 9, 10, 11, 12, 13, 14, 15, 16, 17, 18, 19, 20, 21, 22, 23, 24, 27, 30 mm; ④ 1/2" (12.7 mm) x 21 mm; ⑤ 1/2" (12.7 mm) x 250 mm; ⑥ 1/2" (12.7 mm) x 125 mm

No.	pcs	☐
58240	24	5

PL Komplet nasadek z akcesoriami
 GB Socket set
 D Sechskantenschlüssel-Einsatz
 RUS Набор торцевых головок

CZ Sada nástrčných klíčů a ráčny
 RO Trusă chei tubulare cu antrenor
 H Dugókulcs készlet racsnis hajtókarral
 E Juego de boquillas con accesorios

52
PCS



① 1/4" (6.3 mm) x 125 mm; 1/2" (12.7 mm) x 250 mm; ② 1/4" (6.3 mm): 4, 4.5, 5, 5.5, 6, 7, 8, 9, 10, 11, 13 mm; 1/2" (12.7 mm): 10, 11, 12, 13, 14, 15, 16, 17, 18, 19, 22, 27, 30 mm; ③ 1/2" (12.7 mm) x 21 mm;
 ④ 1/4" (6.3 mm) x 110 mm; 1/2" (12.7 mm) x 250 mm; ⑤ 1/4" (6.3 mm) x 6 mm; ⑥ 1/4" (6.3 mm) x 75 mm; 1/2" (12.7 mm) x 125 mm; 1/2" (12.7 mm) x 250 mm; ⑦ 1/4" (6.3 mm) x 140 mm;
 ⑧ 1/4" (6.3 mm); 1/2" (12.7 mm); ⑨ 3, 4, 5, 6, 7, 8 mm; ⑩ 4, 5; 5; 7 mm; ⑪ PH1; PH2; PH3; ⑫ 1.5; 2; 2.5 mm

No.	pcs	☐
58520	52	5

PL Komplet nasadek z akcesoriami
 GB Socket set
 D Sechskantenschlüssel-Einsatz
 RUS Набор торцевых головок

CZ Sada nástrčných klíčů a ráčny
 RO Trusă chei tubulare cu antrenor
 H Dugókulcs készlet racsnis hajtókarral
 E Juego de boquillas con accesorios

20
PCS



① 3/8" (9.5 mm) x 190 mm; ② 1/4" (6.3 mm) x 50 mm; ③ 3/8" (9.5 mm) x 21 mm;
 ④ 3/8" (9.5 mm) x 70 mm; ⑤ 3/8" (9.5 mm); ⑥ 1/4" (6.3 mm) x 3/8" (9.5 mm); ⑦ 1/4" (6.3 mm): 4, 4.5, 5, 5.5, 6, 7, 8, 9, 10, 11, 12 mm; ⑧ 3/8" (9.5 mm): 13, 14, 17 mm

No.	pcs	☐
58210	20	10

PL Komplet nasadek z akcesoriami
 GB Socket set
 D Sechskantenschlüssel-Einsatz
 RUS Набор торцевых головок

CZ Sada nástrčných klíčů a ráčny
 RO Trusă chei tubulare cu antrenor
 H Dugókulcs készlet racsnis hajtókarral
 E Juego de boquillas con accesorios

24
PCS



① 1/2" (12.7 mm) x 240 mm; ② 1/2" (12.7 mm): 10, 11, 12, 13, 14, 15, 16, 17, 18, 19, 20, 21, 22, 23, 24, 27, 30, 32 mm; ③ 1/2" (12.7 mm) x 21 mm; ④ 1/2" (12.7 mm) x 250 mm; ⑤ 1/2" (12.7 mm) x 390 mm; ⑥ 1/2" (12.7 mm) x 125 mm; 1/2" (12.7 mm) x 250 mm

No.	pcs	☐
58260	24	5

PL Komplet nasadek z grzechotką
 GB Ratchet handle with socket set
 D Sechskant-Steckschlüssel-Satz
 RUS Трещотка с насадками

CZ Sada nástrčných klíčů a ráčny
 RO Rotrusă chei tubulare cu antrenor
 H Dugókulcs készlet racsnis hajtókarral
 E Matraca con boquillas

11
PCS

72T

CrV



VOREL

No.	mm	L (mm)	size / rozmiar	☐
58600	5; 6; 7; 8; 9; 10; 11; 12; 13; 14	150	1/4" (6.3 mm)	6/24
58602	10; 11; 12; 13; 14; 15; 17; 19; 22; 24	260	1/2" (12.7 mm)	12

PL Komplet nasadek z akcesoriami
GB Socket set
D Sechskantenschlüssel-Einsatz
RUS Набор торцевых головок

CZ Sada nástrčných klíčů a ráčny
RO Trusă chei tubulare cu antrenor
H Dugókulcs készlet racsnis hajtókarral
E Juego de boquillas con accesorios

12
PCS

1/2"
12.5mm

45T

AS-DRIVE



1/2" (12.7 mm): 10, 11, 12, 13, 14, 15, 17, 19, 21, 24 mm; 1/2" (12.7 mm); 45T



No.	pcs	
58633	12	5/10

PL Komplet nasadek z akcesoriami
GB Socket set
D Sechskantenschlüssel-Einsatz
RUS Набор торцевых головок
CZ Sada nástrčných klíčů a ráčny
RO Trusă chei tubulare cu antrenor
H Dugókulcs készlet racsnis hajtókarral
E Juego de boquillas con accesorios

14
PCS

3/4"
19mm



3/4" (19.0 mm) x 495 mm; 3/4" (19.0 mm) x 100; 200 mm; 3/4" (19.0 mm): 22, 24, 27, 30, 32, 36, 38, 41, 46, 50 mm; 3/4" (19.0 mm) x 456 mm

No.	size / rozmiar	pcs	
58140	3/4" (19.0 mm)	14	2

PL Zestaw narzędziowy
GB Tool set
D Sechskant-Steckschlüssel-Satz
RUS Набор торцевых головок

CZ Sada nástrčných klíčů a ráčny
RO Rotrușa chei tubulare cu antrenor
H Dugókulcs készlet racsnis hajtókarral
E Juego de herramientas

38
PCS

1/4"
6.3mm

45T

AS-DRIVE



1/4" (6.3 mm): 3.5, 4, 4.5, 5, 5.5, 6, 7, 8, 9, 10, 11, 12, 13, 14 mm; 1/4" (6.3 mm); 1/4" (6.3 mm) x2; 1/4" (6.3 mm); 1/4" (6.3 mm); 1/4" (6.3 mm); 45T; 1/4" (6.3 mm); 1/4" (6.3 mm); 4, 5.5, 6.5 mm; PH1, PH2; 1/4" (6.3 mm); PH1, PH2; PZ1, PZ2; 1/4" (6.3 mm): T10, T15, T20, T25, T30, T40; 1/4" (6.3 mm): 3, 4, 5, 6, 8 mm



No.	pcs	
58640	38	10

PL Komplet nasadek z grzechotką
GB Ratchet handle with socket set
D Sechskant-Steckschlüssel-Satz
RUS Трещотка с насадками

CZ Sada nástrčných klíčů a ráčny
RO Rotrușa chei tubulare cu antrenor
H Dugókulcs készlet racsnis hajtókarral
E Matraca con boquillas

19
PCS

1/2"
12.5mm

45T

AS-DRIVE



1/2" (12.7 mm): 8, 9, 10, 11, 12, 13, 14, 15, 16, 17, 19, 21, 22, 23, 24, 27, 30, 32 mm; 1/2" (12.7 mm); 45T



No.	pcs	
58634	19	4/8

PL Komplet nasadek z akcesoriami
GB Socket set
D Sechskantenschlüssel-Einsatz
RUS Набор торцевых головок
CZ Sada nástrčných klíčů a ráčny
RO Trusă chei tubulare cu antrenor
H Dugókulcs készlet racsnis hajtókarral
E Juego de boquillas con accesorios

20
PCS

3/4"
19mm



3/4" (19.0 mm) x 495 mm; 3/4" (19.0 mm) x 100; 200 mm; 3/4" (19.0 mm): 22, 24, 26, 27, 28, 30, 32, 34, 36, 38, 41, 42, 45, 46, 48, 50 mm; 3/4" (19.0 mm) x 456 mm

No.	pcs	
58150	20	2

PL Zestaw narzędziowy
GB Tool set
D Sechskant-Steckschlüssel-Satz
RUS Набор торцевых головок

CZ Sada nástrčných klíčů a ráčny
RO Rotrușa chei tubulare cu antrenor
H Dugókulcs készlet racsnis hajtókarral
E Juego de herramientas

42
PCS

1/4"
6.3mm

45T

AS-DRIVE



1/4" (6.3 mm): 4, 4.5, 5, 5.5, 6, 7, 8, 9, 10, 11, 12, 13, 14 mm; 1/4" (6.3 mm): 8, 9, 10, 11, 12, 13 mm; 1/4" (6.3 mm) x2; 1/4" (6.3 mm); 1/4" (6.3 mm); 1/4" (6.3 mm); 1/4" (6.3 mm); 1/4" (6.3 mm); 45T; 1/4" (6.3 mm); 1/4" (6.3 mm); 1/4" (6.3 mm) x 1/4" (6.3 mm); 1/4" (6.3 mm); 3, 4, 5 mm; PH0, PH1, PH2; PZ0, PZ1, PZ2; 1/4" (6.3 mm): 6, 7, 8 mm; 1.5, 2.0, 2.5 mm



No.	pcs	
58641	42	10

PL Zestaw narzędziowy
GB Tool set
D Sechskant-Steckschlüssel-Satz
RUS Набор торцовых головок

CZ Sada nástrčných klíčů a ráčny
RO Rotruasa chei tubulare cu antrenor
H Dugókulcs készlet racsnis hajtókarral
E Juego de herramientas

44 PCS
1/4"
6.3mm

CrV 6140 AS-DRIVE

45T



1/4" (6.3 mm): 4, 4.5, 5, 5.5, 6, 7, 8, 9, 10, 11, 12, 13, 14 mm; 1/4" (6.3 mm): 8, 9, 10, 11, 12, 13 mm; 1/4" (6.3 mm) x2; 1/4" (6.3 mm); 1/4" (6.3 mm); 1/4" (6.3 mm); 1/4" (6.3 mm); 1/4" (6.3 mm); 1/4" (6.3 mm); 45T; 1/4" (6.3 mm); 1/4" (6.3 mm) x 1/4" (6.3 mm); 3, 4, 5 mm; CrV 6140; 1/4" (6.3 mm); PH0, PH1, PH2; CrV 6140; 1/4" (6.3 mm); PZ0, PZ1, PZ2; CrV 6140; 1/4" (6.3 mm); 6, 7 mm; CrV 6140; 3.6V; 5V= 1A; 1.5, 2.0, 2.5 mm



No.	pcs	
58645	44	4

PL Zestaw narzędziowy
GB Tool set
D Sechskant-Steckschlüssel-Satz
RUS Набор торцовых головок

CZ Sada nástrčných klíčů a ráčny
RO Rotruasa chei tubulare cu antrenor
H Dugókulcs készlet racsnis hajtókarral
E Juego de herramientas

56 PCS
1/4"
6.3mm

45T AS-DRIVE



1/4" (6.3 mm): 4, 4.5, 5, 5.5, 6, 7, 8, 9, 10, 11, 12, 13 mm; 1/4" (6.3 mm): 6, 7, 8, 9, 10, 11, 12, 13 mm; 1/4" (6.3 mm): E4, E5, E6, E7, E8, E10; 1/4" (6.3 mm) x2; 1/4" (6.3 mm); 1/4" (6.3 mm); 1/4" (6.3 mm); 1/4" (6.3 mm); 45T; 1/4" (6.3 mm); 1/4" (6.3 mm) (F) x 3/8" (9.5mm) (M); 1/4" (6.3 mm); 4, 5.5, 6.5 mm; 1/4" (6.3 mm); PH1, PH2, PH3; 1/4" (6.3 mm); PZ1, PZ2, PZ3; 1/4" (6.3 mm); T8, T10, T15, T20, T25, T30, T40; 1/4" (6.3 mm) 3, 4, 5, 6, 7, 8 mm



No.	pcs	
58642	56	10

PL Zestaw narzędziowy
GB Tool set
D Sechskant-Steckschlüssel-Satz
RUS Набор торцовых головок

CZ Sada nástrčných klíčů a ráčny
RO Rotruasa chei tubulare cu antrenor
H Dugókulcs készlet racsnis hajtókarral
E Juego de herramientas

22 PCS
3/8"
10mm

45T AS-DRIVE



3/8" (9.5 mm): 6, 7, 8, 9, 10, 11, 12, 13, 14, 15, 16, 17, 18, 19, 20, 21, 22 mm; 3/8" (9.5 mm); 3/8" (9.5 mm); 3/8" (9.5 mm); 45T



No.	pcs	
58661	22	10

PL Zestaw narzędziowy
GB Tool set
D Sechskant-Steckschlüssel-Satz
RUS Набор торцовых головок

CZ Sada nástrčných klíčů a ráčny
RO Rotruasa chei tubulare cu antrenor
H Dugókulcs készlet racsnis hajtókarral
E Juego de herramientas

72 PCS
1/2"
12.5mm

1/4" 6.3mm CrV 6140

45T AS-DRIVE



1/2" (12.7 mm): 10, 11, 12, 13, 14, 15, 16, 17, 18, 19, 20, 21, 22, 23, 24, 27 mm; 1/4" (6.3 mm): 4, 5, 6, 7, 8, 9, 10, 11, 12, 13 mm; 1/2" (12.7 mm) x2; 1/4" (6.3 mm); 3/8" (9.5 mm) (F) x 1/2" (12.7 mm) (M); 1/2" (12.7 mm); 1/2" (12.7 mm); 21 mm; 1/2" (12.7 mm); 1/4" (6.3 mm); 45T; 1/4" (6.3 mm); 1/4" (6.3 mm); 1/4" (6.3 mm) x 1/4" (6.3 mm); 1/4" (6.3 mm); 4, 5, 5.5, 6, 7 mm; CrV 6140; PH0, PH1, PH2, PH3; CrV 6140; 1/4" (6.3 mm); PZ0, PZ1, PZ2, PZ3; CrV 6140; 1/4" (6.3 mm); T8, T9, T10, T15, T20, T25, T27, T30, T40; CrV 6140; 1/4" (6.3 mm); 3, 4, 5, 6, 7, 8 mm; CrV 6140; 1/4" (6.3 mm); S0, S1, S2, S3; CrV 6140; 1.25, 1.5, 2.5, 3 mm



No.	pcs	
58705	72	4

PL Zestaw narzędziowy
GB Tool set
D Sechskant-Steckschlüssel-Satz
RUS Набор инструментов

CZ Sada nástrčných klíčů a ráčny
RO Rotruasa chei tubulare cu antrenor
H Dugókulcs készlet racsnis hajtókarral
E Juego de herramientas

56 PCS
1/4"
6.3mm

45T AS-DRIVE

CrV 50BV30



1/4" (6.3 mm): 4, 4.5, 5, 5.5, 6, 7, 8, 9, 10, 11, 12, 13 mm; 1/4" (6.3 mm): 6, 7, 8, 9, 10, 11, 12, 13 mm; 1/4" (6.3 mm): E4, E5, E6, E7, E8, E10; CrV 6150; 1/4" (6.3 mm) x2; 1/4" (6.3 mm); 1/4" (6.3 mm); 1/4" (6.3 mm); 1/4" (6.3 mm); 45T; 1/4" (6.3 mm); 1/4" (6.3 mm) (F) x 3/8" (9.5 mm) (M); 1/4" (6.3 mm); 4, 5.5, 6.5 mm; 1/4" (6.3 mm); PH1, PH2, PH3; 1/4" (6.3 mm); PZ1, PZ2, PZ3; 1/4" (6.3 mm); T8, T10, T15, T20, T25, T30, T40; 1/4" (6.3 mm); 3, 4, 5, 7, 6, 8 mm



No.	pcs	
58643	56	10

PL Zestaw narzędziowy
GB Tool set
D Sechskant-Steckschlüssel-Satz
RUS Набор инструментов

CZ Sada nástrčných klíčů a ráčny
RO Rotruasa chei tubulare cu antrenor
H Dugókulcs készlet racsnis hajtókarral
E Juego de herramientas

72 PCS
1/2"
12.5mm

1/4" 6.3mm CrV 6140

45T AS-DRIVE



1/2" (12.7 mm): 10, 11, 12, 13, 14, 15, 16, 17, 18, 19, 20, 21, 22, 23, 24, 27 mm; 1/4" (6.3 mm): 4, 5, 6, 7, 8, 9, 10, 11, 12, 13 mm; 1/4" (6.3 mm): E4, E5, E6, E7, E8, E10; CrV 6150; 1/2" (12.7 mm); 21 mm; 1/2" (12.7 mm) x2; 1/4" (6.3 mm); 1/2" (12.7 mm); 1/2" (12.7 mm); 1/4" (6.3 mm); 45T; 1/4" (6.3 mm); 1/4" (6.3 mm); 1/4" (6.3 mm) (F) x 1/2" (12.7 mm) (M); 1/4" (6.3 mm) x 1/4" (6.3 mm); 1/4" (6.3 mm); 4, 5, 5.5, 6, 7 mm; CrV 6140; 1/4" (6.3 mm); PH0, PH1, PH2, PH3; CrV 6140; 1/4" (6.3 mm); PZ0, PZ1, PZ2, PZ3; CrV 6140; 1/4" (6.3 mm); T8, T9, T10, T15, T20, T25, T27, T30, T40; CrV 6140; 1/4" (6.3 mm); 3, 4, 5, 6, 7, 8 mm; CrV 6140; 1/4" (6.3 mm); S0, S1, S2, S3; CrV 6140; 1.25, 1.5, 2.5, 3 mm



No.	pcs	
58704	72	4

PL Zestaw narzędziowy
 GB Tool set
 D Sechskant-Steckschlüssel-Satz
 RUS Набор инструментов
 CZ Sada nástrčných klíčů a ráčny
 RO Rotruasa chei tubulare cu antrenor
 H Dugókulcs készlet racsnis hajtókarral
 E Juego de herramientas

82 PCS **1/2"** **1/4"**
12.5mm **6.3mm**
45T AS-DRIVE





1/2" (12.7 mm): 13, 14, 15, 16, 17, 18, 19, 22, 24, 27, 30, 32 mm; 1/4" (6.3 mm): 4, 4.5, 5, 5.5, 6, 7, 8, 9, 10, 11, 12, 13, 14 mm; 1/2" (12.7 mm) x 1/4" (6.3 mm): 1/2" (12.7 mm) (M); 1/4" (6.3 mm) x 1/2" (12.7 mm) (F) x 1/2" (12.7 mm) (M); 1/2" (12.7 mm) x 1/4" (6.3 mm); 1/2" (12.7 mm): 16, 21 mm; 1/4" (6.3 mm): 1/2" (12.7 mm); 1/4" (6.3 mm): 45T; 1/4" (6.3 mm): 1/2" (12.7 mm) x 5/16" (7.9 mm); 1/4" (6.3 mm) x 1/4" (6.3 mm); 5/16" (7.9 mm): 8, 10, 12 mm; 5/16" (7.9 mm): PH3, PH4; 5/16" (7.9 mm): PZ3, PZ4; 5/16" (7.9 mm): T40, T45, T50, T55; 5/16" (7.9 mm): 8, 10, 12, 14 mm; 1/4" (6.3 mm): 4, 5.5, 7 mm; 1/4" (6.3 mm): PH1, PH2; 1/4" (6.3 mm): PZ1, PZ2; 1/4" (6.3 mm): T8, T10, T15, T20, T25, T30; 1/4" (6.3 mm) 3, 4, 5, 6 mm; 8, 10, 11, 12, 13, 14, 17, 19, 22 mm



No.	pcs	Icon
58686	82	3

PL Zestaw narzędziowy
 GB Tool set
 D Sechskant-Steckschlüssel-Satz
 RUS Набор инструментов
 CZ Sada nástrčných klíčů a ráčny
 RO Rotruasa chei tubulare cu antrenor
 H Dugókulcs készlet racsnis hajtókarral
 E Juego de herramientas

94 PCS **1/2"** **1/4"**
12.5mm **6.3mm**
45T AS-DRIVE





1/2" (12.7 mm): 10, 11, 12, 13, 14, 15, 16, 17, 18, 19, 20, 21, 22, 23, 24, 27, 30, 32 mm; 1/4" (6.3 mm): 4, 4.5, 5, 5.5, 6, 7, 8, 9, 10, 11, 12, 13, 14 mm; 1/2" (12.7 mm): 14, 15, 17, 19 mm; 1/4" (6.3 mm): 6, 7, 8, 9, 10, 11, 12, 13 mm; 1/2" (12.7 mm) x 1/4" (6.3 mm) x 2: 1/4" (6.3 mm) x 2: 3/8" (9.5 mm) (F) x 1/2" (12.7 mm) (M); 1/4" (6.3 mm); 1/2" (12.7 mm); 1/4" (6.3 mm): 1/2" (12.7 mm); 1/4" (6.3 mm): 16, 21 mm; 1/4" (6.3 mm): 1/2" (12.7 mm); 1/4" (6.3 mm): 45T; 1/4" (6.3 mm): 1/2" (12.7 mm) x 5/16" (7.9 mm); 1/4" (6.3 mm) x 1/4" (6.3 mm); 5/16" (7.9 mm): 8, 10, 12 mm; 5/16" (7.9 mm): PH3, PH4; 5/16" (7.9 mm): PZ3, PZ4; 5/16" (7.9 mm): T40, T45, T50, T55; 5/16" (7.9 mm): 8, 10, 12, 14 mm; 1/4" (6.3 mm): 4, 5.5, 7 mm; 1/4" (6.3 mm): PH1, PH2; 1/4" (6.3 mm): PZ1, PZ2; 1/4" (6.3 mm): T8, T10, T15, T20, T25, T30; 1/4" (6.3 mm) 3, 4, 5, 6 mm; 1.5, 2, 2.5 mm



No.	pcs	Icon
58683	94	3

PL Zestaw narzędziowy
 GB Tool set
 D Sechskant-Steckschlüssel-Satz
 RUS Набор инструментов
 CZ Sada nástrčných klíčů a ráčny
 RO Rotruasa chei tubulare cu antrenor
 H Dugókulcs készlet racsnis hajtókarral
 E Juego de herramientas

82 PCS **1/2"** **1/4"**
12.5mm **6.3mm**
45T AS-DRIVE





1/2" (12.7 mm): 14, 15, 16, 17, 18, 19, 20, 22, 24, 27, 30, 32 mm; 1/4" (6.3 mm): 4, 4.5, 5, 5.5, 6, 7, 8, 9, 10, 11, 12, 13, 14 mm; 1/2" (12.7 mm) x 2: 1/4" (6.3 mm) x 2; 1/4" (6.3 mm) x 1/4" (6.3 mm); 3/8" (9.5 mm) (F) x 1/2" (12.7 mm) (M); 1/2" (12.7 mm); 1/4" (6.3 mm); 1/2" (12.7 mm): 16, 21 mm; 1/4" (6.3 mm); 1/2" (12.7 mm); 1/4" (6.3 mm): 45T; 1/4" (6.3 mm): 1/2" (12.7 mm) x 5/16" (7.9 mm); 1/4" (6.3 mm) x 1/4" (6.3 mm); 5/16" (7.9 mm): 8, 10, 12 mm; 5/16" (7.9 mm): PH3, PH4; 5/16" (7.9 mm): PZ3, PZ4; 5/16" (7.9 mm): T40, T45, T50, T55; 5/16" (7.9 mm): 8, 10, 12, 14 mm; 1/4" (6.3 mm): 4, 5.5, 7 mm; 1/4" (6.3 mm): PH1, PH2; 1/4" (6.3 mm): PZ1, PZ2; 1/4" (6.3 mm): T8, T10, T15, T20, T25, T30; 1/4" (6.3 mm): 3, 4, 5, 6 mm; 8, 10, 11, 12, 13, 14, 17, 19, 22 mm



No.	pcs	Icon
58689	82	3

PL Zestaw narzędziowy
 GB Tool set
 D Sechskant-Steckschlüssel-Satz
 RUS Набор инструментов
 CZ Sada nástrčných klíčů a ráčny
 RO Rotruasa chei tubulare cu antrenor
 H Dugókulcs készlet racsnis hajtókarral
 E Juego de herramientas

94 PCS **1/2"** **1/4"**
12.5mm **6.3mm**
45T AS-DRIVE



1/2" (12.7 mm): 10, 11, 12, 13, 14, 15, 16, 17, 18, 19, 20, 21, 22, 23, 24, 27, 30, 32; 1/4" (6.3 mm): 4, 4.5, 5, 5.5, 6, 7, 8, 9, 10, 11, 12, 13, 14 mm; 1/2" (12.7 mm): 14, 15, 17, 19 mm; 1/4" (6.3 mm): 6, 7, 8, 9, 10, 11, 12, 13 mm; 1/2" (12.7 mm) x 2: 1/4" (6.3 mm) x 2; 3/8" (9.5 mm) (F) x 1/2" (12.7 mm) (M); 1/4" (6.3 mm); 1/2" (12.7 mm); 1/4" (6.3 mm): 1/2" (12.7 mm); 1/4" (6.3 mm): 16, 21 mm; 1/4" (6.3 mm); 1/2" (12.7 mm); 1/4" (6.3 mm): 45T; 1/4" (6.3 mm): 1/2" (12.7 mm) x 5/16" (7.9 mm); 1/4" (6.3 mm) x 1/4" (6.3 mm); 5/16" (7.9 mm): 8, 10, 12 mm; 5/16" (7.9 mm): PH3, PH4; 5/16" (7.9 mm): PZ3, PZ4; 5/16" (7.9 mm): T40, T45, T50, T55; 5/16" (7.9 mm): 8, 10, 12, 14 mm; 1/4" (6.3 mm): 4, 5.5, 7 mm; 1/4" (6.3 mm): PH1, PH2; 1/4" (6.3 mm): PZ1, PZ2; 1/4" (6.3 mm): T8, T10, T15, T20, T25, T30; 1/4" (6.3 mm): 3, 4, 5, 6 mm; 1.5, 2, 2.5 mm



No.	pcs	Icon
58687	94	3

PL Zestaw narzędziowy
 GB Tool set
 D Sechskant-Steckschlüssel-Satz
 RUS Набор инструментов
 CZ Sada nástrčných klíčů a ráčny
 RO Rotruasa chei tubulare cu antrenor
 H Dugökölcs készlet racsnis hajtókarral
 E Juego de herramientas

108 PCS	1/2" 12.5mm	1/4" 6.3mm	CrV 50BV30
	45T	AS-DRIVE	



1/2" (12.7 mm): 10, 11, 12, 13, 14, 15, 16, 17, 18, 19, 20, 21, 22, 24, 27, 30, 32 mm; 1/4" (6.3 mm): 4, 4.5, 5, 5.5, 6, 7, 8, 9, 10, 11, 12, 13, 14 mm; 1/2" (12.7 mm): 14, 15, 17, 19, 22 mm; 1/4" (6.3 mm): 6, 7, 8, 9, 10, 11, 12, 13 mm; 1/2" (12.7 mm): E10, E11, E12, E14, E16, E18, E20, E24; 1/4" (6.3 mm): E4, E5, E6, E7, E8; CrV 50BV30; 1/2" (12.7 mm) x2; 1/4" (6.3 mm) x2; 3/8" (9.5 mm) (F) x 1/2" (12.7 mm) (M); 1/2" (12.7 mm): 1/4" (6.3 mm); 1/2" (12.7 mm): 16, 21 mm; 1/4" (6.3 mm): 1/2" (12.7 mm); 1/4" (6.3 mm); 45T; 1/4" (6.3 mm); 1/2" (12.7 mm) (F) x 5/16" (7.9 mm) (F); 5/16" (7.9 mm): 8, 10, 12 mm; 5/16" (7.9 mm): PH3, PH4; 5/16" (7.9 mm): PZ3, PZ4; 5/16" (7.9 mm): T40, T45, T50, T55, T60; 5/16" (7.9 mm): 7, 8, 10, 12, 14 mm; 1/4" (6.3 mm): 4, 5.5, 6.5 mm; 1/4" (6.3 mm) PH1, PH2; 1/4" (6.3 mm): PZ1, PZ2; 1/4" (6.3 mm): T8, T10, T15, T20, T25, T27, T30; 1/4" (6.3 mm): 3, 4, 5, 6; 1.5, 2, 2.5 mm

STHOR

No.	pcs	
58685	108	3

PL Zestaw narzędziowy
 GB Tool set
 D Sechskant-Steckschlüssel-Satz
 RUS Набор инструментов
 CZ Sada nástrčných klíčů a ráčny
 RO Rotruasa chei tubulare cu antrenor
 H Dugökölcs készlet racsnis hajtókarral
 E Juego de herramientas

111 PCS	1/2" 12.5mm	3/8" 10mm	1/4" 6.3mm
	CrV 6140	45T	AS-DRIVE



1/2" (12.7 mm): 14, 15, 16, 17, 18, 19, 20, 21, 22, 23, 24, 27, 30, 32 mm; 3/8" (9.5 mm): 9, 10, 11, 12, 13, 14, 15, 16, 17, 18, 19 mm; 1/4" (6.3 mm): 3.5, 4, 4.5, 5, 5.5, 6, 7, 8, 9, 10, 11, 12, 13 mm; 1/2" (12.7 mm) x2; 3/8" (9.5 mm) x2; 1/4" (6.3 mm) x2; 3/8" (9.5 mm) (F) x 1/2" (12.7 mm) (M); 1/2" (12.7 mm) (F) x 3/8" (9.5 mm) (M); 3/8" (9.5 mm) (F) x 1/4" (6.3 mm) (M); 1/2" (12.7 mm): 16, 21 mm; 3/8" (9.5 mm): 16, 21 mm; 1/2" (12.7 mm): 1/2" (12.7 mm); 3/8" (9.5 mm); 1/4" (6.3 mm); 1/4" (6.3 mm); 1/2" (12.7 mm) x 5/16" (7.9 mm); 3/8" (9.5 mm) x 5/16" (7.9 mm); 5/16" (7.9 mm): PZ2, PZ3; CrV 6140; 5/16" (7.9 mm): T27, T30, T35, T40, T45; CrV 6140; 5/16" (7.9 mm): 5.5, 6, 6.5 mm; CrV 6140; 1/4" (6.3 mm): 4, 5.5, 6.5 mm; CrV 6140; 1/4" (6.3 mm): PH1, PH2; CrV 6140; 1/4" (6.3 mm): PZ1, PZ2; CrV 6140; 1/4" (6.3 mm): T8, T10, T15, T20, T25; CrV 6140; 1/4" (6.3 mm): T10, T15, T20, T25, T40; CrV 6140; 1/4" (6.3 mm): 3, 4, 5, 6 mm; CrV 6140; 8, 9, 10, 11, 12, 13, 14, 15, 16, 17, 18, 19 mm; 1.5, 2, 2.5 mm

STHOR

No.	pcs	
58692	111	1

PL Zestaw narzędziowy
 GB Tool set
 D Sechskant-Steckschlüssel-Satz
 RUS Набор инструментов
 CZ Sada nástrčných klíčů a ráčny
 RO Rotruasa chei tubulare cu antrenor
 H Dugökölcs készlet racsnis hajtókarral
 E Juego de herramientas

109 PCS	1/2" 12.5mm	1/4" 6.3mm	CrV 50BV30
	CrV 6140	45T	



1/2" (12.7 mm): 10, 11, 12, 13, 14, 15, 16, 17, 18, 19, 20, 21, 22, 24, 27, 30, 32 mm; 1/4" (6.3 mm): 4, 4.5, 5, 5.5, 6, 7, 8, 9, 10, 11, 12, 13, 14 mm; 1/4" (6.3 mm): 6, 7, 8, 9, 10, 11, 12, 13 mm; 1/2" (12.7 mm): E10, E11, E12, E14, E16, E18, E20, E24; 1/4" (6.3 mm): E4, E5, E6, E7, E8; CrV 50BV30; 1/2" (12.7 mm) x2; 1/4" (6.3 mm) x2; 3/8" (9.5 mm) (F) x 1/2" (12.7 mm) (M); 1/2" (12.7 mm): 1/4" (6.3 mm); 1/2" (12.7 mm): 16, 21 mm; 1/4" (6.3 mm): 1/2" (12.7 mm); 1/4" (6.3 mm); 45T; 1/4" (6.3 mm); 1/2" (12.7 mm) (F) x 5/16" (7.9 mm) (F); 5/16" (7.9 mm): 8, 10, 12 mm; 1/4" (6.3 mm): 4, 5, 5.5, 6, 7 mm; CrV 6140; 5/16" (7.9 mm): PH3, PH4; 1/4" (6.3 mm); PH0, PH1, PH2, PH3; CrV 6140; 5/16" (7.9 mm): PZ3, PZ4; 1/4" (6.3 mm): PZ1, PZ2, PZ3; CrV 6140; 5/16" (7.9 mm): T40, T45, T50, T55, T60; 1/4" (6.3 mm): T8, T9, T10, T15, T20, T25, T27, T30; CrV 6140; 5/16" (7.9 mm): 7, 8, 10, 12, 14 mm; CrV 6140; 3.6V; 5V=1A; 1.5, 2.0, 2.5 mm

STHOR

No.	pcs	
58695	109	2

PL Zestaw narzędziowy
 GB Tool set
 D Sechskant-Steckschlüssel-Satz
 RUS Набор инструментов
 CZ Sada nástrčných klíčů a ráčny
 RO Rotruasa chei tubulare cu antrenor
 H Dugökölcs készlet racsnis hajtókarral
 E Juego de herramientas

122 PCS	1/2" 12.5mm	1/4" 6.3mm	CrV 50BV30
	CrV 6150	45T	



1/2" (12.7 mm): 12, 13, 14, 15, 16, 17, 18, 19, 20, 21, 22, 24, 27, 30, 32 mm; 1/4" (6.3 mm): 4, 4.5, 5, 5.5, 6, 7, 8, 9, 10, 11, 12, 13, 14 mm; 1/2" (12.7 mm): 10, 12, 13, 14, 17, 19 mm; 1/4" (6.3 mm): 4, 5, 6, 7, 8, 9 mm; 1/2" (12.7 mm): E10, E12, E14, E16, E18, E20, E22, E24; CrV 50BV30; 1/2" (12.7 mm): 1/4" (6.3 mm) x2; 3/8" (9.5 mm) (F) x 1/2" (12.7 mm) (M); 3/8" (9.5 mm) (F) x 1/4" (6.3 mm) (M); 1/2" (12.7 mm): 1/4" (6.3 mm); 1/2" (12.7 mm): 16, 21 mm; 1/2" (12.7 mm): 1/2" (12.7 mm); 1/4" (6.3 mm); 45T; 1/4" (6.3 mm); 1/4" (6.3 mm) x 1/4" (6.3 mm); 1/4" (6.3 mm); 1/4" (6.3 mm); 3, 4, 5, 6 mm; 1/4" (6.3 mm): PH0, PH1, PH2; 1/4" (6.3 mm): PZ0, PZ1, PZ2; 1/4" (6.3 mm): 4.0, 5.5, 6.5 mm; 1/4" (6.3 mm): PH1, PH2, PH3; 1/4" (6.3 mm): PZ2, PZ3; 1/4" (6.3 mm): T8, T10, T15, T20, T25; 1/4" (6.3 mm): T10, T15, T20, T25, T40; 1/4" (6.3 mm): 3, 4, 5, 6 mm; 8, 9, 10, 11, 12, 13, 14, 15, 16, 17, 18, 19 mm; 4x100, 6.5x150, PH2x100, PH3x150 mm; CrV 6150; 160 mm; 160 mm; 180 mm; 250 mm; 300 g; 2, 2.5, 3, 4, 5, 6, 7, 8, 10 mm

STHOR

No.	pcs	
58690	122	2

PL Zestaw narzędziowy
 GB Tool set
 D Sechskant-Steckschlüssel-Satz
 RUS Набор инструментов
 CZ Sada nástrčných klíčů a ráčny
 RO Rotruasa chei tubulare cu antrenor
 H Dugókulcs készlet racsnis hajtókarral
 E Juego de herramientas

173 PCS	1/2" 12.5mm	3/8" 10mm	1/4" 6.3mm
CrV 50BV30	45T	AS-DRIVE	



1/2" (12.7 mm): 10, 11, 12, 13, 14, 15, 16, 17, 18, 19, 20, 21, 22, 23, 24, 27, 30, 32 mm; 3/8" (9.5 mm): 10, 11, 12, 13, 14, 15, 16, 17, 18, 19 mm; 1/4" (6.3 mm): 4, 4.5, 5, 5.5, 6, 7, 8, 9, 10, 11, 12, 13, 14 mm; 1/2" (12.7 mm): 16, 17, 18, 19, 22 mm; 3/8" (9.5 mm): 10, 11, 12, 13, 14, 15 mm; 1/4" (6.3 mm): 4, 5, 6, 7, 8, 9, 10 mm; 1/2" (12.7 mm): E18, E20, E24; 3/8" (9.5 mm): E10, E11, E12, E14, E16, E18; 1/4" (6.3 mm): E4, E5, E6, E7, E8; CrV 50BV30: 1/2" (12.7 mm) x2; 3/8" (9.5 mm): 1/4" (6.3 mm) x2; 3/8" (9.5 mm) (F) x 1/2" (12.7 mm) (M); 1/2" (12.7 mm); 3/8" (9.5 mm); 1/4" (6.3 mm); 1/2" (12.7 mm): 16, 21 mm; 3/8" (9.5 mm): 18 mm; 1/4" (6.3 mm); 1/2" (12.7 mm): 3/8" (9.5 mm); 1/4" (6.3 mm): 45T; 1/4" (6.3 mm) x 1/4" (6.3 mm); 1/2" (12.7 mm) x 5/16" (7.9 mm); 3/8" (9.5 mm) x 5/16" (7.9 mm); 1/4" (6.3 mm) x 1/4" (6.3 mm); 5/16" (7.9 mm): 8, 10, 12 mm; 5/16" (7.9 mm): PH3, PH4; 5/16" (7.9 mm): PZ3, PZ4; 5/16" (7.9 mm): T40, T45, T50, T55, T60, T70; 1/4" (6.3 mm): T4, T5, T6, T7; 1/4" (6.3 mm): T7, T10, T15, T20, T25, T27, T30, T40, T45; 1/4" (6.3 mm): M5, M6, M8; 1/4" (6.3 mm): RM5, RM6, RM7, RM8, RM9; 1/4" (6.3 mm): 4, 5, 5.5, 6, 6.5, 7 mm; 1/4" (6.3 mm): PH0, PH1, PH2; 1/4" (6.3 mm) PZ0, PZ1, PZ2; 1/4" (6.3 mm): T8, T9, T10, T15, T20, T25, T27, T30; 1/4" (6.3 mm): T8, T9, T10, T15, T20, T25, T27, T30; 1/4" (6.3 mm): 3, 4, 5, 6 mm; 1.25, 1.5, 2, 2.5, 3, 4, 5 mm



No.	pcs	
58688	173	1

PL Zestaw narzędziowy
 GB Tool set
 D Sechskant-Steckschlüssel-Satz
 RUS Набор инструментов
 CZ Sada nástrčných klíčů a ráčny
 RO Rotruasa chei tubulare cu antrenor
 H Dugókulcs készlet racsnis hajtókarral
 E Juego de herramientas



No.	pcs	
58691	216	1

PL Zestaw narzędziowy
 GB Tool set
 D Sechskant-Steckschlüssel-Satz
 RUS Набор инструментов
 CZ Sada nástrčných klíčů a ráčny
 RO Rotruasa chei tubulare cu antrenor
 H Dugókulcs készlet racsnis hajtókarral
 E Juego de herramientas

216 PCS	1/2" 12.5mm	3/8" 10mm	1/4" 6.3mm	CrV 50BV30
CrV 6140	45T	AS-DRIVE		



1/2" (12.7 mm): 10, 11, 12, 13, 14, 15, 17, 19, 20, 21, 22, 24, 27, 30, 32 mm; 3/8" (9.5 mm): 10, 11, 12, 13, 14, 15, 16, 17, 18, 19 mm; 1/4" (6.3 mm): 4, 4.5, 5, 5.5, 6, 7, 8, 9, 10, 11, 12, 13, 14 mm; 1/2" (12.7 mm): 16, 17, 18, 19, 22 mm; 3/8" (9.5 mm): 10, 11, 12, 13, 14, 15 mm; 1/4" (6.3 mm): 4, 5, 6, 7, 8, 9, 10 mm; 1/2" (12.7 mm): E20, E22, E24; 3/8" (9.5 mm): E10, E11, E12, E14, E16, E18; 1/4" (6.3 mm): E4, E5, E6, E7, E8; CrV 50BV30: 1/2" (12.7 mm) x2; 3/8" (9.5 mm): 1/4" (6.3 mm) x2; 3/8" (9.5 mm) (F) x 1/2" (12.7 mm) (M); 1/2" (12.7 mm); 3/8" (9.5 mm); 1/4" (6.3 mm); 1/2" (12.7 mm): 16, 21 mm; 3/8" (9.5 mm): 18 mm; 1/4" (6.3 mm); 1/2" (12.7 mm): 3/8" (9.5 mm); 1/4" (6.3 mm): 45T; 1/4" (6.3 mm) x 1/4" (6.3 mm); 1/2" (12.7 mm) x 5/16" (7.9 mm); 3/8" (9.5 mm) x 5/16" (7.9 mm); 1/4" (6.3 mm) x 1/4" (6.3 mm); 5/16" (7.9 mm): 6, 6.5, 8 mm; 1/4" (6.3 mm): 4, 5.5, 6.5 mm; CrV 6140; 5/16" (7.9 mm): PH3, PH4; 1/4" (6.3 mm): PH1, PH2; CrV 6140; 5/16" (7.9 mm): PZ3, PZ4; 1/4" (6.3 mm): PZ1, PZ2; CrV 6140; 5/16" (7.9 mm): T25, T27, T30, T35, 2xT40, T45, T50; 1/4" (6.3 mm): T8, T10, T15, T20, T25; CrV 6140; 5/16" (7.9 mm): T27, T30, T35, T40, T45, T50; 1/4" (6.3 mm): T8, 2xT10, 2xT15, 2xT20, 2xT25, T40; CrV 6140; 5/16" (7.9 mm): 5.5, 6, 6.5, 7, 8 mm; 1/4" (6.3 mm): 3, 4, 5, 6 mm; CrV 6140; 1/4" (6.3 mm): 3, 4, 5, 6 mm; CrV 6140; 5/16" (7.9 mm): M5, M6, M8, M10; 1/4" (6.3 mm): M5, M6, M8; CrV 6140; 1/4" (6.3 mm): S1, S2; CrV 6140; 1/4" (6.3 mm): 1, 2, 3 mm; CrV 6140; 1/4" (6.3 mm): 6, 8, 10 mm; CrV 6140; 1/4" (6.3 mm): 4, 6, 8 mm; CrV 6140; 1/4" (6.3 mm): 6, 6.5, 8 mm; CrV 6140; 1/4" (6.3 mm): PH3, PH4; CrV 6140; 1/4" (6.3 mm): PZ3, PZ4; CrV 6140; 1/2" (12.7 mm): T55, T60; 1/4" (6.3 mm): T25, T27, T30, T35, 2xT40, T45, T50; CrV 6140; 1/4" (6.3 mm): T27, T30, T35, T40, T45, T50; CrV 6140; 1/4" (6.3 mm): 5.5, 6, 6.5, 7, 8 mm; CrV 6140; 1/4" (6.3 mm): M5, M6, M8, M10; 8, 10, 11, 12, 13, 14, 15, 16, 17, 18, 19, 22 mm; 1.27, 1.5, 2, 2.5, 3, 4, 5 mm



No.	pcs	
58700	216	1

216 PCS	1/2" 12.5mm	3/8" 10mm	1/4" 6.3mm	CrV 50BV30	45T	AS-DRIVE	
-------------------	-----------------------	---------------------	----------------------	----------------------	------------	-----------------	--

1/2" (12.7 mm): 10, 11, 12, 13, 14, 15, 17, 19, 20, 21, 22, 24, 27, 30, 32 mm; 3/8" (9.5 mm): 10, 11, 12, 13, 14, 15, 16, 17, 18, 19 mm; 1/4" (6.3 mm): 4, 4.5, 5, 5.5, 6, 7, 8, 9, 10, 11, 12, 13, 14 mm; 1/2" (12.7 mm): 16, 17, 18, 19, 22 mm; 3/8" (9.5 mm): 10, 11, 12, 13, 14, 15 mm; 1/4" (6.3 mm): 4, 5, 6, 7, 8, 9, 10 mm; 1/2" (12.7 mm): E20, E22, E24; 3/8" (9.5 mm): E10, E11, E12, E14, E16, E18; 1/4" (6.3 mm): E4, E5, E6, E7, E8; CrV 50BV30: 1/2" (12.7 mm) x2; 3/8" (9.5 mm): 1/4" (6.3 mm) x2; 3/8" (9.5 mm) (F) x 1/2" (12.7 mm) (M); 1/2" (12.7 mm); 3/8" (9.5 mm); 1/4" (6.3 mm); 1/2" (12.7 mm): 16, 21 mm; 3/8" (9.5 mm): 18 mm; 1/4" (6.3 mm); 1/2" (12.7 mm): 3/8" (9.5 mm); 1/4" (6.3 mm): 45T; 1/4" (6.3 mm) x 1/4" (6.3 mm); 1/2" (12.7 mm) x 5/16" (7.9 mm); 3/8" (9.5 mm) x 5/16" (7.9 mm); 1/4" (6.3 mm) x 1/4" (6.3 mm); 5/16" (7.9 mm): 6, 6.5, 8 mm; 1/4" (6.3 mm): 4, 5.5, 6.5 mm; CrV 6140; 5/16" (7.9 mm): PH3, PH4; 1/4" (6.3 mm): PH1, PH2; CrV 6140; 5/16" (7.9 mm): PZ3, PZ4; 1/4" (6.3 mm): PZ1, PZ2; CrV 6140; 5/16" (7.9 mm): T25, T27, T30, T35, 2xT40, T45, T50; 1/4" (6.3 mm): T8, T10, T15, T20, T25; CrV 6140; 5/16" (7.9 mm): T27, T30, T35, T40, T45, T50; 1/4" (6.3 mm): T8, 2xT10, 2xT15, 2xT20, 2xT25, T40; CrV 6140; 5/16" (7.9 mm): 5.5, 6, 6.5, 7, 8 mm; 1/4" (6.3 mm): 3, 4, 5, 6 mm; CrV 6140; 1/4" (6.3 mm): 3, 4, 5, 6 mm; CrV 6140; 5/16" (7.9 mm): M5, M6, M8, M10; 1/4" (6.3 mm): M5, M6, M8; CrV 6140; 1/4" (6.3 mm): S1, S2; CrV 6140; 1/4" (6.3 mm): 1, 2, 3 mm; CrV 6140; 1/4" (6.3 mm): 6, 8, 10 mm; CrV 6140; 1/4" (6.3 mm): 4, 6, 8 mm; CrV 6140; 1/4" (6.3 mm): 6, 6.5, 8 mm; CrV 6140; 1/4" (6.3 mm): PH3, PH4; CrV 6140; 1/2" (12.7 mm): T55, T60; 1/4" (6.3 mm): T25, T27, T30, T35, 2xT40, T45, T50; CrV 6140; 1/4" (6.3 mm): T27, T30, T35, T40, T45, T50; CrV 6140; 1/4" (6.3 mm): 5.5, 6, 6.5, 7, 8 mm; CrV 6140; 1/4" (6.3 mm): M5, M6, M8, M10; 8, 10, 11, 12, 13, 14, 15, 16, 17, 18, 19, 22 mm; 1.27, 1.5, 2, 2.5, 3, 4, 5 mm

PL Zestaw narzędziowy CZ Sada nástrčných kľúčů a ráčny
 GB Tool set RO Rotruşa chei tubulare cu antrenor
 D Sechskant-Steckschlüssel-Satz H Dugókulcs készlet racsnis hajtókarral
 RUS Набор инструментов E Juego de herramientas

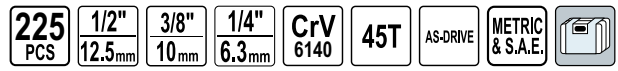

2



No.	pcs	1
58693	225	1

1/2" (12.7 mm): 10, 13, 15, 16, 17, 18, 19, 20, 21, 22, 23, 24, 27, 30, 32 mm; 3/8" (9.5 mm): 10, 11, 12, 13, 14, 15, 16, 17, 18, 19 mm; 1/4" (6.3 mm): 3.5, 4, 4.5, 5, 5.5, 6, 7, 8, 9, 10, 11, 12, 13, 14 mm; 1/2" (12.7 mm): 10, 11, 12, 13, 14, 15, 17, 19, 21 mm; 3/8" (9.5 mm): 6, 7, 8, 9, 10 mm; 1/2" (12.7 mm): 7/16" (11.1 mm), 1/2" (12.7 mm), 9/16" (14.3 mm), 5/8" (15.9 mm), 11/16" (17.5 mm), 3/4" (19.0 mm), 13/16" (20.6 mm), 7/8" (22.2 mm); 1/4" (6.3 mm): 1/4" (6.3 mm), 9/32" (7.1 mm), 5/16" (7.9 mm), 11/32" (8.7 mm), 3/8" (9.5 mm); 1/2" (12.7 mm): 17, 19, 21 mm; 1/2" (12.7 mm): E16, E18, E20, E22, E24; 3/8" (9.5 mm): E10, E11, E12, E14; 1/4" (6.3 mm): E4, E5, E6, E7, E8; 1/2" (12.7 mm) x2, 3/8" (9.5 mm) x2, 1/4" (6.3 mm) x2; 3/8" (9.5 mm) (F) x 1/2" (12.7 mm) (M), 1/2" (12.7 mm) (F) x 3/8" (9.5 mm) (M); 1/2" (12.7 mm), 3/8" (9.5 mm), 1/4" (6.3 mm); 1/2" (12.7 mm): 16, 21 mm, 3/8" (9.5 mm): 18 mm; 1/4" (6.3 mm); 1/4" (6.3 mm); 1/4" (6.3 mm); 1/2" (12.7 mm), 3/8" (9.5 mm), 1/4" (6.3 mm); 45T; 1/4" (6.3 mm); 1/4" (6.3 mm); 1/4" (6.3 mm); 1/2" (12.7 mm) x 5/16" (7.9 mm), 3/8" (9.5 mm) x 5/16" (7.9 mm), 3/8" (9.5 mm) x 1/4" (6.3 mm), 1/4" (6.3 mm) x 1/4" (6.3 mm); 3/8" (9.5 mm) x 1/4" (6.3 mm), 1/4" (6.3 mm) x 1/4" (6.3 mm) x2; 1/4" (6.3 mm) x 1/4" (6.3 mm); 5/16" (7.9 mm); 8, 10 mm; 1/4" (6.3 mm): 3, 4, 5.5, 6.5, 7, 8, 9 mm; CrV 6140: 5/16" (7.9 mm): PH3, PH4; 1/4" (6.3 mm): PH0, PH1, PH2, PH3; CrV 6140: 5/16" (7.9 mm): PZ3, PZ4; 1/4" (6.3 mm): PZ0, PZ1, PZ2, PZ3; CrV 6140: 5/16" (7.9 mm): T20, T25, T27, T30, T40, T45, T50, T55 (L=75 mm); T40, T45, T50, T55, T60, T70 (L=30 mm); 1/4" (6.3 mm): T8, T9, T10, T15, T20, T25, T27, T30; CrV 6140: 5/16" (7.9 mm): T40, T45, T50, T55, T60, T70; 1/4" (6.3 mm): T8, T9, T10, T15, T20, T25, T27, T30; CrV 6140: 5/16" (7.9 mm): 10, 12, 14 mm; 1/4" (6.3 mm): 3, 4, 5, 6, 7, 8 mm; CrV 6140: 1/4" (6.3 mm): 4, 5, 6, 7, 8 mm; CrV 6140: 1/4" (6.3 mm): M5, M6, M8, M10; CrV 6140: 1/4" (6.3 mm): S1, S2; CrV 6140: 1/4" (6.3 mm): 1, 2, 3, 4; CrV 6140: 8, 9, 10, 1/4" (6.3 mm): 6, 8, 10; CrV 6140: 1/4" (6.3 mm): 4, 6, 8, 10 mm; CrV 6140: 8, 9, 10, 11, 12, 13, 14, 15, 16, 17, 19, 22 mm; 6x38, PH2x38; 180 mm; 250 mm; 2, 2.5, 3, 4, 5, 6, 7, 8, 10, 12 mm

Memo	
------	--

Memo

3

Screwdrivers & screwdriver bits Wkrętaki i końcówki wkrętakowe



Screwdrivers, 3 colour handle
Wkrętaki, trójkolorowa rączka

28-29

Slotted screwdrivers

Wkrętaki płaskie..... 28

Phillips screwdrivers

Wkrętaki krzyżakowe..... 28

Pozidrive screwdrivers

Wkrętaki „Pozidrive”..... 28

Torx screwdrivers

Wkrętaki „Torx”..... 28

Screwdriver sets

Komplety wkrętaków..... 28

Ratchet screwdrivers

Wkrętaki z grzechotką..... 28

Screwdrivers HI-TEC & sets
Wkrętaki HI-TEC i zestawy

29-30

Slotted screwdrivers

Wkrętaki płaskie..... 29

Phillips screwdrivers

Wkrętaki krzyżakowe..... 29

Torx screwdrivers

Wkrętaki „Torx”..... 30

Torx Security screwdrivers

Wkrętaki „Torx Security”..... 30

Screwdriver sets

Komplety wkrętaków..... 30

Special & impact screwdrivers
Wkrętaki specjalne i udarowe

31-35

Two way screwdrivers

Wkrętaki dwustronne..... 31

Ratchet screwdriver sets with bits

Zestawy wkrętaków z grzechotką i bitami..... 32

Impact screwdrivers

Wkrętaki udarowe..... 34

Telescopic screwdrivers

Wkrętaki teleskopowe..... 35

T-bar screwdrivers

Wkrętaki T-gryf..... 35

Screwdriver sets

Zestawy wkrętaków



35-36

Precision screwdrivers setsZestawy wkrętaków
precyzyjnych

36-37

Screwdriver bits

Kończówki wkrętakowe



37-40

Screwdriver bit sets

Zestawy końcówek wkrętakowych..... 37

Screwdriver bit holders

Uchwyty do końcówek wkrętakowych..... 40

Nut setter sets

Zestawy nasadek magnetycznych do wkrętarek..... 40

Hex & Torx keys & sets

Klucze imbusowe i zestawy



40-42

Hex keys

Klucze imbusowe „Hex”..... 40

Hex key sets

Zestawy kluczy imbusowych „Hex”..... 40

Torx & Torx Tamperproof key setsZestawy kluczy imbusowych „Torx”
i „Torx Tamperproof”..... 41

PL Wkrętak płaski
GB Slotted screwdriver
D Schraubendreher schlitz
RUS Отвёртка шлицевая

CZ Šroubovák
RO Şurubelniţă
H Csavarhúzó
E Destornillador



VOREL

No.	mm	pcs packing	☐
60912	2x75	12	96/384
60950	3x75	12	96/384
60951	3x100	12	96/384
60952	4x100	12	96/384
60913	4x150	12	96/384
60914	4x200	12	60/240
60915	5x38	12	60/240
60953	5x75	12	60/240
60954	5x100	12	60/240
60955	5x150	12	60/240
60916	5x200	12	36/144
60917	6x38	12	60/240
60956	6x100	12	36/144
60957	6x150	12	36/144
60958	6x200	12	36/144
60959	8x150	6	24/96
60918	8x250	6	24/96

PL Wkrętak
GB Screwdriver
D Schraubendreher
RUS Отвёртка крестовая

CZ Šroubovák
RO Şurubelniţă
H Csavarhúzó
E Destornillador



VOREL

No.	mm	pcs packing	☐
60931	PZ0x75	12	96/384
60932	PZ0x100	12	96/384
60933	PZ1x75	12	60/240
60934	PZ1x100	12	60/240
60935	PZ1x200	12	36/144
60936	PZ2x100	12	36/144
60937	PZ2x150	12	36/144
60938	PZ2x200	12	36/144
60939	PZ3x150	6	24/96

PL Komplet wkrętaków
GB Screwdriver set
D Schraubendreher-Satz
RUS Набор отвёрток

CZ Zámečnické šroubováky
RO Şurubelniţe de lăcătuşerie
H Lakatos csavarhúzó
E Juego de destornilladores

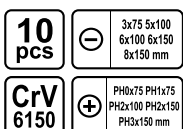

VOREL

No.	pcs	☐
60970	10	6/24

PL Wkrętak krzyżakowy
GB Phillips screwdriver
D Kreuzschlitzschraubendreher
RUS Отвёртка крестовая

CZ Šroubovák křížový
RO Şurubelniţă în cruce
H Csavarhúzó kereszt
E Destornillador cruz



VOREL

No.	mm	pcs packing	☐
60920	PH00x65	12	96/384
60961	PH0x75	12	96/384
60962	PH0x100	12	96/384
60921	PH1x38	12	60/240
60963	PH1x75	12	60/240
60964	PH1x100	12	60/240
60965	PH1x150	12	60/240
60922	PH1x250	12	36/144
60923	PH2x38	12	60/240
60966	PH2x100	12	36/144
60967	PH2x150	12	36/144
60968	PH2x200	12	36/144
60924	PH2x250	12	36/144
60969	PH3x150	6	24/96

PL Wkrętak
GB Screwdriver
D Schraubendreher
RUS Отвёртка

CZ Šroubovák
RO Şurubelniţă
H Csavarhúzó
E Destornillador



VOREL

No.	mm	pcs packing	☐
60880	T5x75	12	96/384
60881	T6x75	12	96/384
60882	T7x75	12	96/384
60883	T8x75	12	96/384
60884	T9x75	12	96/384
60885	T10x100	12	60/240
60886	T15x100	12	60/240
60887	T20x100	12	60/240
60888	T25x100	12	36/144
60889	T27x100	12	36/144
60890	T30x100	12	36/144
60891	T40x100	6	24/96

PL Zestaw wkrętak z grzechotką
GB Ratchet screwdriver set
D Ratschenschraubendreher-Satz mit Einsätzen
RUS Отвёртка реверсивная с набором бит и торцевых головок

CZ Ráčnový kloubový šroubovák
RO Set şurubelniţă
H Dugókulcs és bit készlet csukló
E Juego con destornillador y carraca



VOREL

No.	pcs	☐
60975	29	6/24

PL Zestaw wkrętek z grzechotką
 GB Ratchet screwdriver set
 D Ratschenschraubendreher-Satz mit Einsätzen
 RUS Отвёртка реверсивная с набором бит и торцевых головок
 CZ Ráčnový kloubový šroubovák
 RO Set surubelniță
 H Dugókulcs és bit készlet csukló
 E Juego con destornillador y carraca

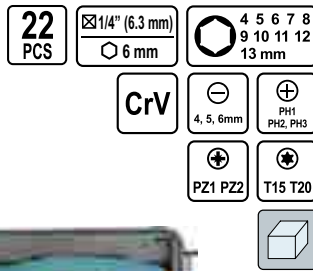

VOREL

No.	pcs	☐
60976	22	12/24

PL Wkrętki płaski
 GB Slotted screwdriver
 D Schraubendreher schlitz
 RUS Отвёртка шлицевая
 CZ Šroubovák
 RO Șurubelniță
 H Csavarhúzó
 E Destornillador



VOREL

No.	mm	☐
61090	6.0x38	12/192

PL Wkrętki krzyżakowy
 GB Phillips screwdriver
 D Kreuzschlitzschraubendreher
 RUS Отвёртка крестовая
 CZ Šroubovák křížový
 RO Șurubelniță în cruce
 H Csavarhúzó kereszt
 E Destornillador cruz



VOREL

No.	mm	☐
61290	PH2x38	12/288

PL Wkrętki krzyżakowy
 GB Phillips screwdriver
 D Kreuzschlitzschraubendreher
 RUS Отвёртка крестовая
 CZ Šroubovák křížový
 RO Șurubelniță în cruce
 H Csavarhúzó kereszt
 E Destornillador cruz

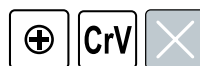

VOREL

No.	mm	☐
61210	PH0x63	12/240
61220	PH0x75	12/240
61230	PH0x100	12/240
61240	PH0x150	12/240

PL Wkrętki płaski
 GB Slotted screwdriver
 D Schraubendreher schlitz
 RUS Отвёртка
 CZ Šroubovák
 RO Șurubelniță
 H Csavarhúzó
 E Destornillador



VOREL

No.	mm	☐
61010	2.5x63	12/240
61020	3.2x75	12/240
61030	3.2x100	12/240
61040	3.2x150	12/240
61050	5.0x75	12/240
61060	5.0x100	12/240
61070	5.0x150	12/240
61080	5.0x200	12/240

PL Wkrętki płaski
 GB Slotted screwdriver
 D Schraubendreher schlitz
 RUS Отвёртка шлицевая
 CZ Šroubovák
 RO Șurubelniță
 H Csavarhúzó
 E Destornillador



VOREL

No.	mm	☐
61100	6.0x100	12/144
61110	6.0x100	HEX 12/144
61120	6.0x150	12/144
61130	6.0x150	HEX 12/144
61140	6.0x200	12/144
61150	6.0x250	12/144
61160	8.0x150	6/72
61170	8.0x150	HEX 6/72

PL Wkrętki krzyżakowy
 GB Phillips screwdriver
 D Kreuzschlitzschraubendreher
 RUS Отвёртка крестовая
 CZ Šroubovák křížový
 RO Șurubelniță în cruce
 H Csavarhúzó kereszt
 E Destornillador cruz



VOREL

No.	mm	☐
61250	PH1x75	12/240
61260	PH1x100	12/240
61270	PH1x150	12/240
61280	PH1x200	12/240

PL Wkrętak krzyżakowy
GB Phillips screwdriver
D Kreuzschlitzschraubendreher
RUS Отвёртка крестовая

CZ Šroubovák křížový
RO Şurubelniţă în cruce
H Csavarhúzó kereszt
E Destornillador cruz



VOREL

No.	mm		
61300	PH2x100		12/144
61310	PH2x100	HEX	12/144
61320	PH2x150		12/144
61330	PH2x150	HEX	12/144
61340	PH2x200		12/144
61350	PH2x250		12/144

PL Wkrętak
GB Screwdriver
D Schraubendreher
RUS Отвёртка

CZ Šroubovák
RO Şurubelniţă
H Csavarhúzó
E Destornillador



VOREL

No.	mm		
61375	T5x75		12/240
61376	T6x75		12/240
61377	T7x75		12/240
61378	T8x75		12/240
61379	T9x75		12/240

PL Wkrętak
GB Screwdriver
D Schraubendreher
RUS Отвёртка

CZ Šroubovák
RO Şurubelniţă
H Csavarhúzó
E Destornillador



VOREL

No.	mm		
61392	T10x200		12/240
61393	T15x200		12/240
61394	T20x200		12/240
61395	T25x200		12/144

PL Komplet wkrętek
GB Screwdriver set
D Schraubendrehersatz
RUS Набор отвёрток

CZ Zámečnické šroubováky
RO Şurubelniţe de lăcătuşerie
H Lakatos csavarhúzó
E Juego de destornilladores

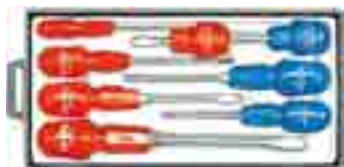

VOREL

No.	pcs		
61590	8		5/20

PL Wkrętak krzyżakowy
GB Phillips screwdriver
D Kreuzschlitzschraubendreher
RUS Отвёртка крестовая

CZ Šroubovák křížový
RO Şurubelniţă în cruce
H Csavarhúzó kereszt
E Destornillador cruz



VOREL

No.	mm		
61360	03x150		6/72
61370	03x150	HEX	6/72

PL Wkrętak
GB Screwdriver
D Schraubendreher
RUS Отвёртка

CZ Šroubovák
RO Şurubelniţă
H Csavarhúzó
E Destornillador



VOREL

No.	mm		
61380	T10x100		12/240
61381	T15x100		12/240
61382	T20x100		12/240
61383	T25x100		12/144
61384	T27x100		12/144
61385	T30x100		12/144
61386	T40x100		12/144

PL Komplet wkrętek
GB Screwdriver set
D Schraubendrehersatz
RUS Набор отвёрток
CZ Zámečnické šroubováky
RO Şurubelniţe de lăcătuşerie
H Lakatos csavarhúzó
E Juego de destornilladores



VOREL

No.	pcs	packing:	
61550	5		5/20
61560	6		6/24
61580	8		6/12

PL Komplet wkrętek
GB Screwdriver set
D Schraubendrehersatz
RUS Набор отвёрток

CZ Zámečnické šroubováky
RO Şurubelniţe de lăcătuşerie
H Lakatos csavarhúzó
E Juego de destornilladores



VOREL

No.	pcs		
61600	10		6/12

PL Wkrętak
GB Screwdriver
D Schraubendreher
RUS Отвёртка с 2-мя двусторонними вставками

CZ Šroubovák
RO Şurubelniţă
H Csavarhúzó
E Destornillador

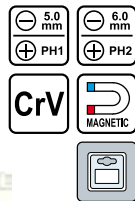

No.	pcs	box
61640	2	8/96

PL Wkrętak płasko-krzyżakowy
GB Slotted - phillips screwdriver
D Umsteckschraubendreher
RUS Отвёртка двухсторонняя

CZ Plochý a křížový šroubovák
RO Şurubelniţă dublu cap: plata + cruce
H Csavarhúzó, lapos-kereszt
E Destornillador plano-cruz

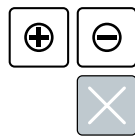

No.	type	box
60930	R-3	25/100

PL Wkrętak dwustronny
GB Two-way screwdriver
D Schraubendreher mit Doppelschlitz
RUS Отвёртка двухсторонняя со сменными вставками

CZ Dvoustranný šroubovák
RO Şurubelniţă dublu capăt
H Kétoldalas csavarhúzó
E Destornillador de dos caras

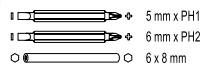

No.	pcs	box
64654	4	12/72

PL Wkrętak
GB Screwdriver
D Schraubendreher
RUS Отвёртка магнитная с битами

CZ Šroubovák
RO Şurubelniţă
H Csavarhúzó
E Destornillador



No.	bits	box
65040	5	25/100

PL Wkrętak płasko-krzyżakowy
GB Slotted - phillips screwdriver
D Umsteckschraubendreher
RUS Отвёртка двухсторонняя

CZ Plochý a křížový šroubovák
RO Şurubelniţă dublu cap: plata + cruce
H Csavarhúzó, lapos-kereszt
E Destornillador plano-cruz

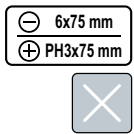

No.	type	box
60910	R-1	30

PL Wkrętak dwustronny
GB Two-way screwdriver
D Umsteckschraubendreher
RUS Отвёртка двухсторонняя

CZ Dvoustranný šroubovák
RO Şurubelniţă dublu capăt
H Kétoldalas csavarhúzó
E Destornillador de dos caras



No.	box
64950	25/100

PL Komplet wkrętek
GB Screwdriver set
D Schraubendrehersatz
RUS Набор отвёрток

CZ Zámečnické šroubováky
RO Şurubelniţe de lăcătuşerie
H Lakatos csavarhúzó
E Juego de destornilladores

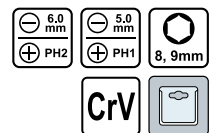

No.	box
64951	12/72

PL Wkrętak
GB Screwdriver
D Schraubendreher
RUS Отвёртка магнитная с битами

CZ Šroubovák
RO Şurubelniţă
H Csavarhúzó
E Destornillador

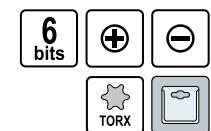

No.	bits	box
65041	6	25/100

- PL Wkrętek wyginany
 GB Screwdriver
 D Schraubendreher
 RUS Отвёртка с набором бит-гибкая
- CZ Ohybaný šroubovák
 RO Şurubelniţă flexibilă + bituri
 H Hajlítóttszárú csavarbehajtó
 E Destornillador con extensión flexible



No.	bits	
65080	7	12/48

- PL Zestaw wkrętek z grzechotką i bitami
 GB Ratchet screwdriver set with bits
 D Schraubendreher mit Ratche
 RUS Отвёртка реверсивная с набором бит
 CZ Šroubovák z řehačkou
 RO Şurubelniţă cu clichet
 H Racsnis csavarbehajtó
 E Juego con destornillador y carraca

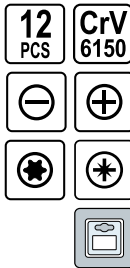

- 1/4" (6.3 mm): 3.5, 4, 5.5 mm (L=25 mm)
- 1/4" (6.3 mm): PH0, PH1, PH2 (L=25 mm)
- 1/4" (6.3 mm): T20, T25 (L=25 mm)
- 1/4" (6.3 mm): P20, PZ1, PZ2 (L=25 mm)

No.	pcs	
64658	12	12/72

- PL Zestaw wkrętek z grzechotką i bitami
 GB Ratchet screwdriver set with bits
 D Schraubendreher mit Ratche
 RUS Отвёртка реверсивная с набором бит
 CZ Šroubovák z řehačkou
 RO Şurubelniţă cu clichet
 H Racsnis csavarbehajtó
 E Juego con destornillador y carraca

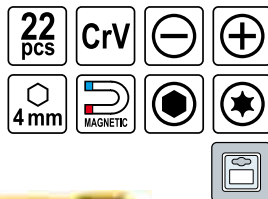

- 1.5, 2.0, 2.5, 3.0 mm; CrV;
- PH000, PH00, PH0, PH1; CrV;
- 1.5, 2.0, 2.5, 3.0, 4.0 mm; CrV;
- T6, T7, T8, T9, T10, T15, T20; CrV;
- 115 mm; CrV

No.	pcs	
64402	22	6/36

- PL Zestaw wkrętek z grzechotką
 GB Ratchet screwdriver set
 D Ratschenschraubendreher-Satz mit Einsätzen
 RUS Набор инструментов, отвёртка + головки + насадки
 CZ Ráčnový kloubový šroubovák
 RO Set surubelnita
 H Dugókulcs és bit készlet csukló
 E Juego con destornillador y carraca



No.	pcs	
65170	41	15/30

- PL Zestaw wkrętek z grzechotką i bitami
 GB Ratchet screwdriver set with bits
 D Schraubendreher mit Ratche
 RUS Отвёртка реверсивная с набором бит
 CZ Šroubovák z řehačkou
 RO Şurubelniţă cu clichet
 H Racsnis csavarbehajtó
 E Juego con destornillador y carraca

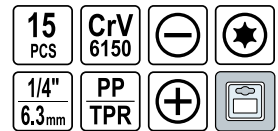

- 1/4" (6.3 mm): 6, 7, 8, 9, 10 mm;
- 1/4" (6.3 mm); CrV 6150;
- 1/4" (6.3 mm); (L=25 mm); CrV 6150;
- 1/4" (6.3 mm): 3, 4, 6 mm (L=25 mm); CrV 6150;
- 1/4" (6.3 mm): PH0, PH1, PH2 (L=25 mm); CrV 6150;
- 1/4" (6.3 mm): T15, T20 (L=25 mm); CrV 6150



No.	pcs	
65034	15	6/24

- PL Zestaw wkrętek z grzechotką i bitami
 GB Ratchet screwdriver set with bits
 D Schraubendreher mit Ratche
 RUS Отвёртка реверсивная с набором бит
 CZ Šroubovák z řehačkou
 RO Şurubelniţă cu clichet
 H Racsnis csavarbehajtó
 E Juego con destornillador y carraca



- 1/4" (6.3 mm): 4, 5, 6, 7, 8, 9, 10, 11, 12 mm;
- 1/4" (6.3 mm); (L=160 mm); CrV 6150;
- 1/4" (6.3 mm); (L=25 mm); CrV 6150;
- 1/4" (6.3 mm): PH0, PH1, PH2, PH3 (L=25 mm); CrV 6150;
- 1/4" (6.3 mm): P20, PZ1, PZ2, PZ3 (L=25 mm); CrV 6150;
- 1/4" (6.3 mm): T10, T15, T20 (L=25 mm); CrV 6150



No.	pcs	
65105	25	6/36

PL Zestaw wkrętak z grzechotką i bitami
 GB Ratchet screwdriver set with bits
 D Schraubendreher mit Ratche
 RUS Отвёртка реверсивная с набором бит
 CZ Šroubovák z řehťáčkou
 RO Şurubelniţă cu clichet
 H Racsnis csavarbehajtó
 E Juego con destornillador y carraca

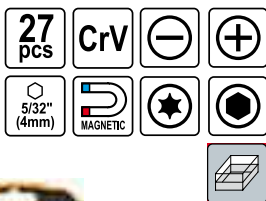

- 1 2.0, 3.0, 4.0 mm (L=50 mm); CrV;
- 2.5, 3.0, 3.5, 4.0, 4.5, 5.0 mm (L=55 mm); CrV;
- PH00, PH0, PH1, PH2 (L=50 mm); CrV;
- 4.0, 4.5, 5.0, 5.5, 6.0 mm;
- T5, T6, T7, T8, T9, T10, T15 (L=50 mm); CrV;
- 4x75 mm; CrV;
- 1 pc 65 mm mini screwdriver / 1 szl. mini wkrętak 95 mm



No.	pcs	box
64386	27	6/48

PL Zestaw wkrętak z grzechotką i bitami
 GB Ratchet screwdriver set with bits
 D Schraubendreher mit Ratche
 RUS Отвёртка реверсивная с набором бит
 CZ Šroubovák z řehťáčkou
 RO Şurubelniţă cu clichet
 H Racsnis csavarbehajtó
 E Juego con destornillador y carraca

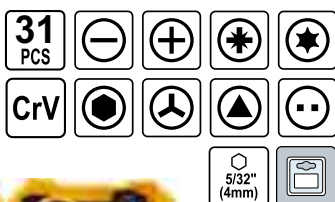

1 pc ratchet screwdriver handle / 1 szl. wkrętak z grzechotką
 1 pc tweezer with 3x magnifying glass / 1 szl. pęseta z lupą 3x
 1 pc storage box / 1 szl. pudełko na bity

- 1.0, 1.5, 2.0, 2.5, 3.0 mm; CrV;
- 0.7, 0.9, 1.3, 1.5, 2.0, 3.0 mm; CrV;
- PH000, PH00, PH0, PH1, PH2; CrV;
- P20, P21; CrV;
- 3.0 mm; CrV;
- T4, T5, T6, T7, T8, T10; CrV;
- 3.0 mm; CrV;
- 115 mm; CrV;
- 2.6 mm; CrV;



No.	pcs	box
65025	31	6/24

PL Zestaw wkrętak z grzechotką i bitami
 GB Ratchet screwdriver set with bits
 D Schraubendreher mit Ratche
 RUS Отвёртка реверсивная с набором бит
 CZ Šroubovák z řehťáčkou
 RO Şurubelniţă cu clichet
 H Racsnis csavarbehajtó
 E Juego con destornillador y carraca

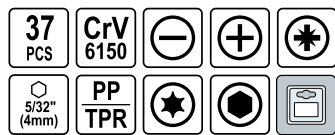

- 5/32" (4 mm); CrV 6150;
- 5/32" (4 mm); (L=100 mm); CrV 6150;
- 5/32" (4 mm); 1.0, 1.5, 2.0, 2.5, 3.0, 3.5 mm (L=28 mm); CrV 6150;
- 5/32" (4 mm); P20, P21 (L=28 mm); CrV 6150;
- 5/32" (4 mm); T4, T5, T6, T7, T8, T9, T10, T15, T20 (L=28 mm); CrV 6150;
- 5/32" (4 mm); 0.7, 0.9, 1.3, 2.0, 2.5, 3.0, 4.0 mm (L=28 mm); CrV 6150;
- 5/32" (4 mm); PH000, PH00, PH0, PH1 (L=28 mm); CrV 6150;
- 5/32" (4 mm); 2.5, 3.0, 3.5, 4.0, 4.5, 5.0, 5.5 mm

No.	pcs	box
65022	37	6/24

PL Wkrętak z grzechotką i wymiennymi końcówkami
 GB Ratchet screwdriver set with bits
 D Schraubendreher mit Ratche
 RUS Отвёртки с набором бит
 CZ Šroubovák z řehťáčkou
 RO Şurubelniţă cu clichet
 H Racsnis csavarbehajtó
 E Juego con destornillador y carraca

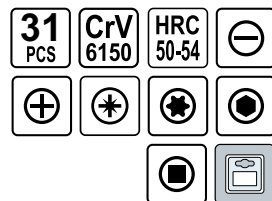

- 1/4" (6.3 mm); 3, 3.5, 4, 5, 5.5, 6 mm (L=25 mm)
- 1/4" (6.3 mm); PH0, PH1, PH2, PH3 (L=25 mm)
- 1/4" (6.3 mm); T10, T15, T20, T25, T27, T30 (L=25 mm)
- 1/4" (6.3 mm); P20, P21, P22, P23 (L=25 mm)
- 1/4" (6.3 mm); 2, 2.5, 3, 4, 5, 6 mm (L=25 mm)
- 1/4" (6.3 mm); S0, S1 (L=25 mm)
- 2.0 x 50 mm
- PH00 x 50 mm



No.	pcs	box
64655	31	6/36

PL Wkrętak z grzechotką i wymiennymi końcówkami
 GB Ratchet screwdriver set with bits
 D Schraubendreher mit Ratche
 RUS Отвёртка реверсивная с набором бит
 CZ Šroubovák z řehťáčkou
 RO Şurubelniţă cu clichet
 H Racsnis csavarbehajtó
 E Juego con destornillador y carraca

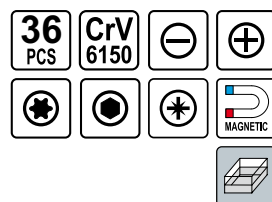

- 1/4" (6.3 mm); 3, 3.5, 4, 5.5 mm (L=25 mm)
- 1/4" (6.3 mm); PH0, PH1, PH2, PH3 (L=25 mm)
- 1/4" (6.3 mm); T10, T15, T20, T25, T27, T30 (L=25 mm)
- 1/4" (6.3 mm); P29, PZ1, PZ2, PZ3 (L=25 mm)
- 1/4" (6.3 mm); 3, 4 mm (L=25 mm)
- 1/4" (6.3 mm); 4, 4.5, 5, 6, 7, 8, 9, 10, 11, 12, 13 mm
- 50 mm



No.	pcs	box
64660	36	6/24

PL Zestaw wkrętak z grzechotką i bitami
 GB Ratchet screwdriver set with bits
 D Schraubendreher mit Ratche
 RUS Отвёртка реверсивная с набором бит
 CZ Šroubovák z řehťáčkou
 RO Şurubelniţă cu clichet
 H Racsnis csavarbehajtó
 E Juego con destornillador y carraca

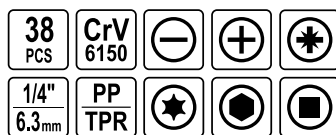

- 1/4" (6.3 mm); 4, 5, 6, 7, 8, 9, 10, 11, 12 mm;
- 1/4" (6.3 mm); PH0, PH1, PH2, PH3 (L=25 mm); CrV 6150;
- 1/4" (6.3 mm); P20, P21, P22, P23 (L=25 mm); CrV 6150;
- 1/4" (6.3 mm); T10, T15, T20, T25, T27, T30 (L=25 mm); CrV 6150;
- 1/4" (6.3 mm); (L=25 mm); CrV 6150;
- 1/4" (6.3 mm); 2, 3, 4, 5, 6 mm (L=25 mm); CrV 6150;
- 1/4" (6.3 mm); 3, 4, 5, 6 mm (L=25 mm); CrV 6150;
- 1/4" (6.3 mm); S0, S1, S2, S3 (L=25 mm); CrV 6150

No.	pcs	box
65023	38	6/24

PL Zestaw wkrętek z grzechotką i bitami
 GB Ratchet screwdriver set with bits
 D Schraubendreher mit Ratche
 RUS Отвёртка реверсивная с набором бит
 CZ Šroubovák z řehačkou
 RO Şurubelniţă cu clichet
 H Racsnis csavarbehajtó
 E Juego con destornillador y carraca



- 1/4" (6.3 mm): 5, 6, 7, 8, 9, 10 mm (L=20 mm); CrV;
- 3.0, 4.0, 5.0, 6.0 mm; CrV;
- 1/8" (3.2 mm), 5/32" (4.0 mm), 3/16" (4.8 mm), 1/4" (6.3 mm); CrV;
- 50, S1, S2, S3 mm; CrV;
- PH0, PH1, PH2, PH3; CrV;
- P20, P21, P22, P23; CrV;
- T15, T20, T25, T30; CrV;
- 1/4" (6.3 mm); (L=25 mm); CrV;
- 1/4" (6.3 mm) (L=60 mm); CrV;



1 pc 115 mm mini ratchet screwdriver / 1 szt. mini wkrętkaz z grzechotką 115 mm

No.	pcs	
64385	41	6/24

PL Zestaw wkrętek z grzechotką i bitami
 GB Ratchet screwdriver set with bits
 D Schraubendreher mit Ratche
 RUS Отвёртка реверсивная с набором бит
 CZ Šroubovák z řehačkou
 RO Şurubelniţă cu clichet
 H Racsnis csavarbehajtó
 E Juego con destornillador y carraca

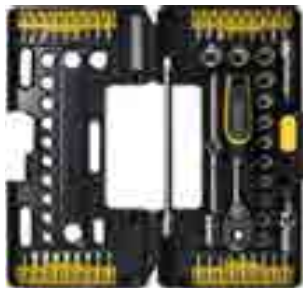
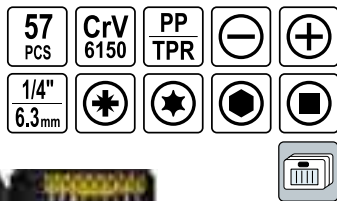

- 1/4" (6.3 mm): 4, 4.5, 5, 5.5, 6, 7, 8, 9, 10, 11, 12, 13 mm (L=25 mm); CrV 6150;
- 1/4" (6.3 mm); (50, 150 mm); CrV 6150;
- 1/4" (6.3 mm); CrV 6150;
- 1/4" (6.3 mm); (115 mm); CrV 6150;
- 1/4" (6.3 mm); (155 mm); CrV 6150;
- 1/4" (6.3 mm) x 1/4" (6.3 mm); CrV 6150;
- 1/4" (6.3 mm): 3, 4, 5 x 2, 6 x 2, 7 x 2 mm (L=25 mm); CrV 6150;
- 1/4" (6.3 mm): PH0, PH1 x2, PH2 x2, PH3 x2 (L=25 mm); CrV 6150;
- 1/4" (6.3 mm): P20, P21 x2, P22 x2, P23 x2 (L=25 mm); CrV 6150;
- 1/4" (6.3 mm): T10, T15, T20, T25, T27, T30 (L=25 mm); CrV 6150;
- 1/4" (6.3 mm): 3, 4, 5, 6 mm (L=25 mm); CrV 6150;
- 1/4" (6.3 mm): S0, S1, S2, S3 (L=25 mm); CrV 6150;
- 1.5, 2, 2.5 mm; CrV 6150

No.	pcs	
65020	57	6/12

PL Zestaw wkrętek z grzechotką i bitami
 GB Ratchet screwdriver set with bits
 D Schraubendreher mit Ratche
 RUS Отвёртка реверсивная с набором бит
 CZ Šroubovák z řehačkou
 RO Şurubelniţă cu clichet
 H Racsnis csavarbehajtó
 E Juego con destornillador y carraca

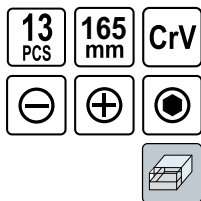

- 5/16" (7.9 mm) 1/2" (12.7 mm);
- 5, 6, 8, 9 mm (L=35 mm);
- PH1, PH2, PH3, PH4 (L=35 mm);
- 4, 5, 6, 8 mm (L=35 mm)

No.	bits	
65123	12	20

PL Zestaw wkrętek z grzechotką i bitami
 GB Ratchet screwdriver set with bits
 D Schraubendreher mit Ratche
 RUS Отвёртка реверсивная с набором бит
 CZ Šroubovák z řehačkou
 RO Şurubelniţă cu clichet
 H Racsnis csavarbehajtó
 E Juego con destornillador y carraca

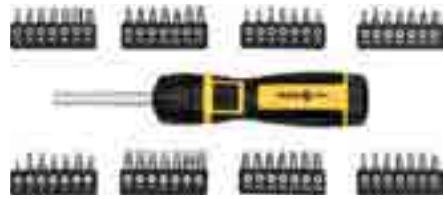
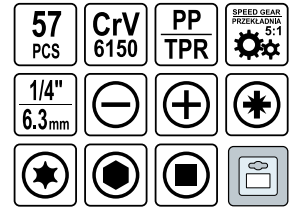

- 1/4" (6.3 mm); CrV 6150;
- 1/4" (6.3 mm): 3 x2, 4 x2, 5 x3, 6 x5, 7 x2 mm (L=25 mm); CrV 6150;
- 1/4" (6.3 mm): PH0 x2, PH1 x2, PH2 x7, PH3 x3 (L=25 mm); CrV 6150;
- 1/4" (6.3 mm): P20, P21 x2, P22 x2, P23 x2 (L=25 mm); CrV 6150;
- 1/4" (6.3 mm): T10, T15, T20, T25 x2, T27, T30 (L=25 mm); CrV 6150;
- 1/4" (6.3 mm): 3, 4 x2, 5 x2, 6 x2 mm (L=25 mm); CrV 6150;
- 1/4" (6.3 mm): S0, S1 x2, S2 x2, S3 x2 (L=25 mm); CrV 6150



No.	pcs	
65033	57	6/12

PL Wkrętkaz udarowy
 GB Impact screwdriver
 D Schlagschrauber
 RUS Отвёртка цельнометаллическая ударная

CZ Narazový šroubovák kovový
 RO Şurubelniţă metalică cu percutor
 H Csavarbehajtó, ütő üzemmóddal
 E Destornillador de percusión



No.	bits	
65120	4	25

PL Wkrętkaz udarowy
 GB Impact screwdriver
 D Schlagschrauber
 RUS Отвёртка слесарная с ударом
 CZ Narazový šroubovák kovový
 RO Şurubelniţă metalică cu percutor
 H Csavarbehajtó, ütő üzemmóddal
 E Destornillador de percusión

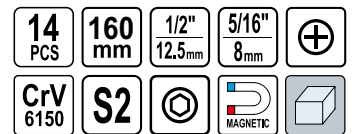

- 5/16" (7.9 mm) 1/2" (12.7 mm);
- 4, 5, 6, 8, 9 mm (L=35 mm); S2;
- PH1, PH2, PH3 (L=35 mm); S2;
- 4, 5, 6, 8 mm (L=35 mm); S2

No.	pcs	
65124	14	20

PL Wkrętak magnetyczny, teleskopowy
 GB Telescopic screwdriver, magnetic
 D Schraubendreher
 RUS Отвёртка магнитная с битами

CZ Magnetický ťoubvak -teleskop
 RO Surubelnita telescopica cu magnet
 H Mágneses csavarbehajtó-teleszkop
 E Destornillador magnético-telescop.



No.	bits	box
65045	6	25/100

PL Wkrętak T-gryf
 GB T-bar screwdriver
 D T-griff Schraubendrehersatz
 RUS Отвёртка с T-образной ручкой и насадками

CZ Šroubovák T-gryf
 RO Set surubelnita tip „T”
 H Csavarbehajtó, T-gyrf
 E Destornillador T-grifo

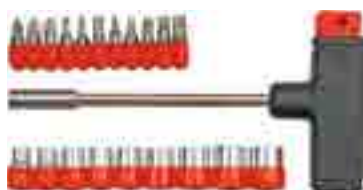

No.	bits	box
65100	20	10/80

PL Komplet wkrętek
 GB Screwdriver set
 D Schraubendrehersatz
 RUS Набор отвёрток слесарных

CZ Zámečnické šroubováky
 RO Șurubelnițe de lăcătușerie
 H Lakatos csavarhózó
 E Juego de destornilladores



No.	pcs	box
64060	6	20/80

PL Komplet wkrętek
 GB Screwdriver set
 D Schraubendrehersatz
 RUS Набор отвёрток

CZ Zámečnické šroubováky
 RO Șurubelnițe de lăcătușerie
 H Lakatos csavarhózó
 E Juego de destornilladores



No.	pcs	box
64070	7	20/80

PL Wkrętak z teleskopowym chwytakiem magnetycznym
 GB Screwdriver with magnetic telescopic pick-up tool
 D Schraubendreher mit auschiebbaren magnetischem Halter
 RUS Отвёртка магнитная с битами
 CZ Magnetický ťoubvak-teleskop
 RO Surubelnita cu magnet-teleskop
 H Mágneses csavarbehajtó-teleszkop
 E Destornillador magnético-telescop

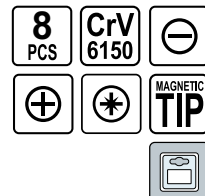

1 1/4" (6,3 mm); 3, 4, 5,5 mm (L=25 mm)
 2 1/4" (6,3 mm); PH1, PH2 (L=25 mm)
 3 1/4" (6,3 mm); PZ1, PZ2 (L=25 mm)

No.	pcs	box
64650	8	12/72

PL Wkrętak T-gryf
 GB T-bar screwdriver set
 D T-griff Schraubendrehersatz
 RUS Отвёртка с T-образной ручкой и насадками
 CZ Šroubovák T-gryf
 RO Set surubelnita tip „T”
 H Csavarbehajtó, T-gyrf
 E Destornillador T-grifo

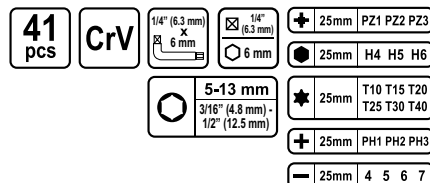

No.	pcs	box
65150	41	24

PL Komplet wkrętek
 GB Screwdriver set
 D Schraubendrehersatz
 RUS Набор отвёрток слесарных

CZ Zámečnické šroubováky
 RO Șurubelnițe de lăcătușerie
 H Lakatos csavarhózó
 E Juego de destornilladores

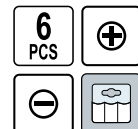

No.	pcs	box
64050	6	20/80

PL Komplet wkrętek
 GB Screwdriver set
 D Schraubendrehersatz
 RUS Набор отвёрток

CZ Zámečnické šroubováky
 RO Șurubelnițe de lăcătușerie
 H Lakatos csavarhózó
 E Juego de destornilladores

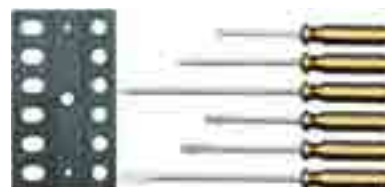
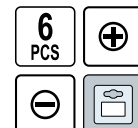

No.	pcs	box
64090	6	10/60

- PL Zestaw wkrętek z grzechotką i bitami
- GB Ratchet screwdriver set with bits
- D Schraubendreher mit Ratche
- RUS Отвёртка реверсивная с набором бит
- CZ Šroubovák z řehačkou
- RO Şurubelniţă cu clichet
- H Racsnis csavarbehajtó
- E Juego con destornillador y carraca

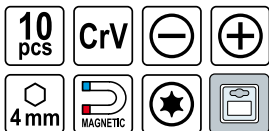

No.	pcs	Box
64400	10	8/144

- ▯ 1.0, 1.5, 2.0 mm; CrV;
- ⊕ PH00, PH0, PH1; CrV;
- ⊗ T6, T7, T8; CrV

- PL Zestaw wkrętek z grzechotką i bitami
- GB Ratchet screwdriver set with bits
- D Schraubendreher mit Ratche
- RUS Отвёртка реверсивная с набором бит
- CZ Šroubovák z řehačkou
- RO Şurubelniţă cu clichet
- H Racsnis csavarbehajtó
- E Juego con destornillador y carraca

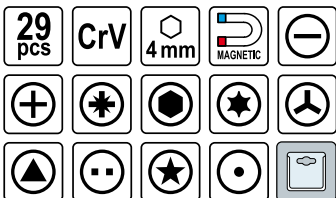

No.	pcs	Box
64401	29	12/48

- ▯ 0.7, 1.0, 1.2, 1.5, 1.8 mm; CrV;
- ⊕ PH000, PH00, PH0, PH1; CrV;
- ⊗ PZ000, PZ00, PZ0, PZ1; CrV;
- ⊖ 0.7, 0.9, 1.3, 1.5, 2.0 mm; CrV;
- ⊗ T4, T5, T6, T7, T8; CrV;
- ⊕ 3.0 mm; CrV;
- ⊖ 3.0 mm; CrV;
- ⊖ 2.6 mm; CrV;
- ⊕ 2.0 mm; CrV;
- ⊖ 1.0 mm; CrV;

- PL Zestaw końcówek śrubokrętowych + uchwyty
- GB Precision screwdriver bits + bit holder
- D Schraubendreherbitsatz + Bithalter
- RUS Отвёртка с набором специальных бит
- CZ Sada bitov + držák
- RO Truse bit + capete şurubel niţă
- H Bitkészlet + szár
- E Juego de llaves especiales + mandril

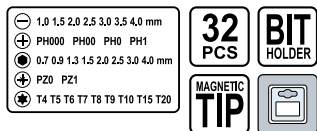

No.	pcs	Box
64371	32	10/20

- PL Zestaw końcówek śrubokrętowych + uchwyty
- GB Precision screwdriver bits + bit holder
- D Schraubendreherbitsatz + Bithalter
- RUS Отвёртка с набором специальных бит
- CZ Sada bitov + držák
- RO Truse bit + capete şurubel niţă
- H Bitkészlet + szár
- E Juego de llaves especiales + mandril

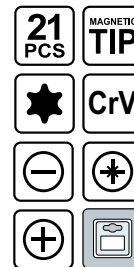

No.	pcs	Box
64370	21	10/60

- PL Zestaw wkrętek z grzechotką i bitami
- GB Ratchet screwdriver set with bits
- D Schraubendreher mit Ratche
- RUS Отвёртка реверсивная с набором бит
- CZ Šroubovák z řehačkou
- RO Şurubelniţă cu clichet
- H Racsnis csavarbehajtó
- E Juego con destornillador y carraca

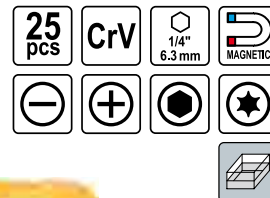

No.	pcs	Box
65880	25	6/24

- ▯ 2.5, 3.0, 4.0, 5.0, 6.0 mm (L=25 mm); CrV;
- ⊕ PH1, PH2 (L=50 mm); CrV;
- ⊗ T20, T25, T27, T30, T40 (L=25 mm); T10, T15 (L=50 mm); CrV;
- ⊖ 2.5, 3.0 mm; 1/8" (3.2 mm), 9/64" (3.6 mm) (L=115 mm); 4.0, 5.0, 6.0 mm; 5/32" (4.0 mm), 3/16" (4.8 mm), 1/4" (6.3 mm) (L=183 mm); CrV

- PL Zestaw wkrętek precyzyjnych
- GB Precision screwdriver set
- D Präzisions-Feinmechanikersatz
- RUS Набор отвёрток для точных работ

- CZ Šroubováky sada
- RO Set surubelnite
- H Órás csavarhúzó készlet
- E Destornilladores precisos

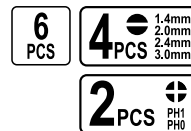

No.	pcs	Box
64310	6	20/100

PL Zestaw wkrętek precyzyjnych
 GB Precision screwdriver set
 D Präzisions-Feinmechanikersatz
 RUS Набор отверток для точных работ
 CZ Šroubováky sada
 RO Set surubelnițe
 H Órás csavarhúzó készlet
 E Destornilladores precisos



No.	pcs	box
64330	11	25/100

PL Zestaw końcówek śrubokrętowych + uchwyt
 GB Precision screwdriver bits + bit holder
 D Schraubendreherbitsatz + Bithalter
 RUS Отвёртка с набором специальных бит
 CZ Sada bitov + držák
 RO Truse bit + capete șurubelniță
 H Bitkészlet + szár
 E Juego de llaves especiales + mandril

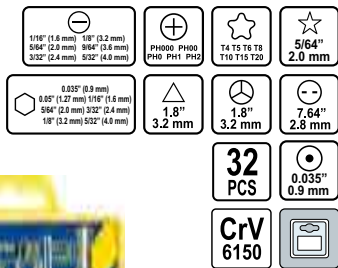

No.	pcs	box
64396	32	10/50

PL Wkrętaki precyzyjne
 GB Precision screwdriver set
 D Präzisions-Schraubendreherersatz
 RUS Набор отверток для точных работ
 CZ Přesní šroubováky
 RO Șurubelnițe precise
 H Precíziós csavarhúzó
 E Destornilladores precisos

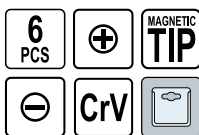

No.	pcs	box
64553	6	10/60
64554	6	10/60

PL Zestaw końcówek śrubokrętowych + uchwyt
 GB Precision screwdriver bits + bit holder
 D Schraubendreherbitsatz + Bithalter
 RUS Отвёртка с набором специальных бит
 CZ Sada bitov + držák
 RO Truse bit + capete șurubelniță
 H Bitkészlet + szár
 E Juego de llaves especiales + mandril



No.	pcs	box
64395	22	10/50

PL Zestaw do naprawy telefonów komórkowych
 GB Mobile phone repair tools set
 D Mobiltelefon Reparatur Satz
 RUS Набор инструмента для ремонта мобильных телефонов
 CZ Nástroje na opravu / otevření mobilních telefonů, sada nástrojů
 RO Set surubelnițe service telefoane mobile
 H Mobiltelefon-javítás szerszámkészlet
 E Herramientas de la reparación del teléfono móvil fijadas

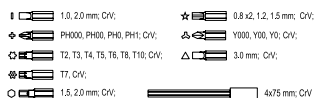

No.	pcs	box
64384	32	6/48

PL Zestaw końcówek śrubokrętowych
 GB Screwdriver bit set
 D Schraubendreherbitsatz
 RUS Биты двухсторонние
 CZ Sada bitů
 RO Truse bit
 H Bitkészlet
 E Puntas de destornilladora

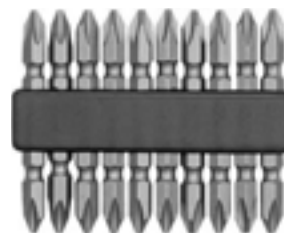
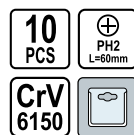

No.	pcs	box
65700	10	25/100

3

- PL Zestaw końcówek śrubokrętowych
 GB Screwdriver bit set
 D Schraubendreherbitsatz
 RUS Набор бит крестовых
- CZ Sada bitů
 RO Truse bit
 H Bitkészlet
 E Puntas de destornilladora



No.	mm	pcs packing	☐
65520	PZ2x25	10	25/200

- PL Końcówki śrubokrętowe do gipsów
 GB Screwdriver bit set
 D Phillips-Bits mit Schutz PH2
 RUS Насадки для быстрого завинчивания саморезов по гипсокартону
 CZ Konečky šroubovákové na sádro
 RO Capete pt. ghips pt. șurubelniță
 H Csavarhúzóvégek gipszhez
 E Puntas con limitador ph2 escayola

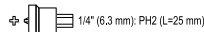

No.	pcs packing	☐
65800	2	12/144

- PL Zestaw końcówek śrubokrętowych
 GB Screwdriver bit set
 D Schraubendreherbitsatz
 RUS Набор бит с шлицами
- CZ Sada bitů
 RO Truse bit
 H Bitkészlet
 E Juego de llaves especiales

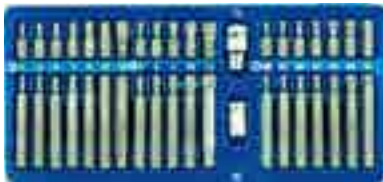

- ☞ 3/8" (9,5 mm): T20, T25, T30, T40, T45, T50, T55 (L=30 mm);
 3/8" (9,5 mm): T20, T25, T30, T40, T45, T50, T55 (L=75 mm);
 ○ 3/8" (9,5 mm): 4, 5, 6, 7, 8, 10, 12 (L=30 mm);
 3/8" (9,5 mm): 4, 5, 6, 7, 8, 10, 12 (L=75 mm);
 ○ 3/8" (9,5 mm): M5, M6, M8, M10, M12 (L=30 mm);
 3/8" (9,5 mm): M5, M6, M8, M10, M12 (L=75 mm);
 □ 1/2" (12,7 mm) x 3/8" (9,5 mm), 3/8" (9,5 mm) x 3/8" (9,5 mm)

No.	pcs	☐
66400	40	10

- PL Zestaw końcówek śrubokrętowych
 GB Screwdriver bit set
 D Schraubendreherbitsatz
 RUS Набор специальных бит
- CZ Sada bitů
 RO Truse bit
 H Bitkészlet
 E Juego de llaves especiales

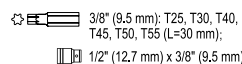
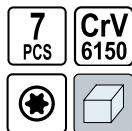

No.	pcs	☐
66570	7	24/72

- PL Zestaw końcówek śrubokrętowych
 GB Screwdriver bit set
 D Schraubendreherbitsatz
 RUS Набор бит крестовых
 CZ Sada bitů
 RO Truse bit
 H Bitkészlet
 E Puntas de destornilladora

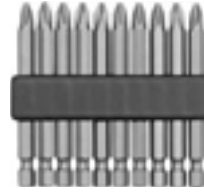

No.	mm	pcs packing	☐
65610	PH1x25	10	25/200
65620	PH1x50	10	25/100
65630	PH2x25	10	25/200
65640	PH2x50	10	25/100
65650	PH2x75	10	25/100

- PL Zestaw końcówek śrubokrętowych
 GB Screwdriver bit set
 D Schraubendreherbitsatz
 RUS Набор битов
- CZ Sada bitů
 RO Truse bit
 H Bitkészlet
 E Puntas de destornilladora

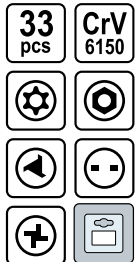

- ☞ 1/4" (6,3 mm): T8, T10, T15, T20, T25, T27, T30, T35, T40 (L=25 mm);
 ○ 1/4" (6,3 mm): 5/64 (2,0 mm), 3/32 (2,4 mm), 7/64 (2,8 mm);
 1/8 (3,2 mm), 9/64 (3,5 mm), 5/32 (4,0 mm) (L=25 mm);
 1/4" (6,3 mm): 2, 2.5, 3, 4, 5, 6 mm (L=25 mm);
 ☞ 1/4" (6,3 mm): 1, 2, 3, 4 (L=25 mm);
 ☞ 1/4" (6,3 mm): 6, 8, 10 (L=25 mm);
 : 1/4" (6,3 mm): 4, 6, 8, 10 (L=25 mm);
 ☞ 1/4" (6,3 mm): (L=60 mm)



No.	pcs	☐
66330	33	12/60

- PL Zestaw końcówek śrubokrętowych
 GB Screwdriver bit set
 D Schraubendreherbitsatz
 RUS Набор бит с шлицами
- CZ Sada bitů
 RO Truse bit
 H Bitkészlet
 E Juego de llaves especiales

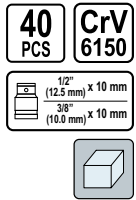

- ☞ 30 mm: T20; T25; T30; T40; T45; T50; T55, 75 mm: T20; T25; T30; T40; T45; T50; T55, ○ 30 mm: H4; H5; H6; H7; H8; H10; H12, 75 mm: H4; H5; H6; H7; H8; H10; H12, ○ 30 mm: M5; M6; M8; M10; M12, 75 mm: M5; M6; M8; M10; M12

No.	pcs	☐
66410	40	10

- PL Zestaw końcówek śrubokrętowych
 GB Screwdriver bit set
 D Schraubendreherbitsatz
 RUS Набор специальных бит
- CZ Sada bitů
 RO Truse bit
 H Bitkészlet
 E Juego de llaves especiales

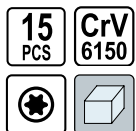

- ☞ 3/8" (9,5 mm): T20, T25, T30, T40, T45, T50, T55 (L=30 mm);
 3/8" (9,5 mm): T20, T25, T30, T40, T45, T50, T55 (L=75 mm);
 □ 1/2" (12,7 mm) x 3/8" (9,5 mm)

No.	pcs	☐
66580	15	20

PL Zestaw końcówek śrubokrętowych
 GB Screwdriver bit set
 D Schraubendreherbitsatz
 RUS Набор специальных бит

CZ Sada bitů
 RO Truse bit
 H Bitkészlet
 E Juego de llaves especiales

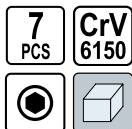

3/8" (9.5 mm): 4, 5, 6, 8, 10, 12 mm (L=30 mm);
 1/2" (12.7 mm) x 3/8" (9.5 mm)

No.	pcs	☐
66710	7	24/72

PL Zestaw końcówek śrubokrętowych
 GB Screwdriver bit set
 D Schraubendreherbitsatz
 RUS Набор специальных бит

CZ Sada bitů
 RO Truse bit
 H Bitkészlet
 E Juego de llaves especiales

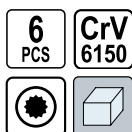

3/8" (9.5 mm): M5, M6, M8, M10, M12 mm (L=30 mm);
 1/2" (12.7 mm) x 3/8" (9.5 mm)

No.	pcs	☐
66760	6	24/72

PL Zestaw końcówek śrubokrętowych
 GB Screwdriver bit set
 D Schraubendreherbitsatz
 RUS Набор бит с магнитным адаптером

CZ Sada bitů
 RO Truse bit
 H Bitkészlet
 E Juego de llaves especiales



No.	pcs	☐
66080	7	20/200

PL Zestaw końcówek śrubokrętowych
 GB Screwdriver bit set
 D Schraubendreherbitsatz
 RUS Набор бит с магнитным адаптером

CZ Sada bitů
 RO Truse bit
 H Bitkészlet
 E Juego de llaves especiales

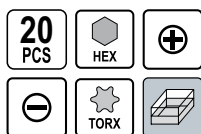

No.	pcs	☐
66210	20	12/48

PL Zestaw końcówek śrubokrętowych
 GB Screwdriver bit set
 D Schraubendreherbitsatz
 RUS Набор специальных бит

CZ Sada bitů
 RO Truse bit
 H Bitkészlet
 E Juego de llaves especiales

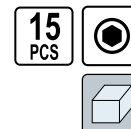

3/8" (9.5 mm): 4, 5, 6, 7, 8, 10, 12 (L=30 mm);
 3/8" (9.5 mm): 4, 5, 6, 7, 8, 10, 12 (L=75 mm);
 1/2" (12.7 mm) x 3/8" (9.5 mm)

No.	pcs	☐
66720	15	20

PL Zestaw końcówek śrubokrętowych
 GB Screwdriver bit set
 D Schraubendreherbitsatz
 RUS Набор специальных бит

CZ Sada bitů
 RO Truse bit
 H Bitkészlet
 E Juego de llaves especiales

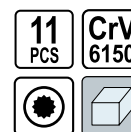

3/8" (9.5 mm): M5, M6, M8, M10, M12 mm (L=30 mm);
 3/8" (9.5 mm): M5, M6, M8, M10, M12 mm (L=75 mm);
 1/2" (12.7 mm) x 3/8" (9.5 mm)

No.	pcs	☐
66770	11	20

PL Zestaw końcówek śrubokrętowych
 GB Screwdriver bit set
 D Schraubendreherbitsatz
 RUS Набор двусторонних бит в держателе

CZ Sada bitů
 RO Truse bit
 H Bitkészlet
 E Juego de llaves especiales

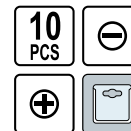

No.	pcs	☐
66112	10	25/100

PL Zestaw końcówek śrubokrętowych
 GB Screwdriver bit set
 D Schraubendreherbitsatz
 RUS Набор бит с магнитным адаптером

CZ Sada bitů
 RO Truse bit
 H Bitkészlet
 E Juego de llaves especiales

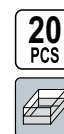

No.	pcs	☐
66200	20	12/48

- PL Uchwyt do końcówek śrubokrętowych
 GB Screwdriver bit holder
 D Bithalter
 RUS Адаптер для бит магнитный
- CZ Držák na šroubovakové koncovky
 RO Capete șurubelniță
 H Szár a csavarhúzóvégekhez
 E Mandril para puntas



No.		
65850		30/300

- PL Klucz sześciokątny
 GB Hex key
 D Sechskant-Stiftschlüssel
 RUS Шестигранник
- CZ Imbusový klíč
 RO Cheie imbus
 H Imbisz kulcs
 E Llave hexagonal



No.	mm	
56040	4	1000/2000
56050	5	400/800
56060	6	400/800
56070	7	300/600
56080	8	200/400
56100	10	100/200
56120	12	50/100
56130	13	50/100
56140	14	50/100
56170	17	25/50

- PL Zestaw kluczy imbusowych
 GB Hex key set
 D Sechskant-Stiftschlüsselsatz
 RUS Набор шестигранников
- CZ Imbusové klíče
 RO Chei imbus
 H Imbisz kulcs
 E Juego de llaves hex



No.	mm	pcs	
56393	1.5; 2; 2.5; 3; 4; 5; 5.5; 6; 8; 10	10	10/60

- PL Komplet końcówek nasadowych
 GB Screwdriver bit set
 D Bit-Steckschlüsselsatz
 RUS Набор торцевых головок
- CZ Sada nastrčných koncoviek
 RO Set de capete tubulare
 H Csőkulcskészlet
 E Juego de puntas de calar

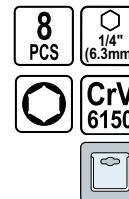

1/4" (6.3 mm): 5, 6, 7, 8, 9, 10, 11, 13 mm; CrV 6150

No.	pcs	
66113	8	25/50

- PL Zestaw kluczy imbusowych
 GB Hex key set
 D Sechskant-Stiftschlüsselsatz
 RUS Набор шестигранников
- CZ Imbusové klíče
 RO Chei imbus
 H Imbisz kulcs
 E Juego de llaves hex



No.	mm	pcs	
56380	2-10	8	20/100
56390	1.5-10	10	20/100

- PL Zestaw kluczy imbusowych
 GB Hex key set
 D Sechskant-Stiftschlüsselsatz
 RUS Набор шестигранников
- CZ Imbusové klíče
 RO Chei imbus
 H Imbisz kulcs
 E Juego de llaves hex

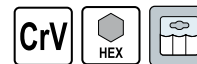

No.	mm	pcs	
56391	1.5-10	10	20/100
56392	2-10	8	20/100

- PL Zestaw kluczy imbusowych
 GB Hex key set
 D Sechskant-Stiftschlüsselsatz
 RUS Набор шестигранников
- CZ Imbusové klíče
 RO Chei imbus
 H Imbisz kulcs
 E Juego de llaves hex

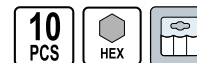

No.	mm	pcs	
56400	2-14	10	20/40

PL Zestaw kluczy imbusowych
GB Hex key set
D Sechskant-Stiftschluselsatz
RUS Набор шестигранных с шаром

CZ Imbusové klíče
RO Chei imbus
H Imbisz kulcs
E Juego de llaves hex

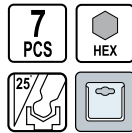

No.	mm	pcs	box
56470	2.5; 3; 4; 5; 6; 8; 10	7	20/40

PL Zestaw kluczy imbusowych
GB Hex key set
D Sechskant-Stiftschluselsatz
RUS Набор шестигранных с шаром

CZ Imbusové klíče
RO Chei imbus
H Imbisz kulcs
E Juego de llaves hex

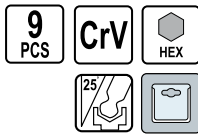

No.	mm	pcs	box
56475	2.5; 3; 4; 5; 5.5; 6; 7; 8; 10	9	10/60

PL Zestaw kluczy imbusowych
GB Hex key set
D Sechskant-Stiftschluselsatz
RUS Набор шестигранных с шаром

CZ Imbusové klíče
RO Chei imbus
H Imbisz kulcs
E Juego de llaves hex

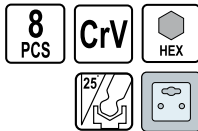

No.	mm	pcs	box
56505	1.5; 2; 2.5; 3; 4; 5; 6; 8	8	25/100

PL Zestaw kluczy imbusowych
GB Hex key set
D Sechskant-Stiftschluselsatz
RUS Набор шестигранных

CZ Imbusové klíče
RO Chei imbus
H Imbisz kulcs
E Juego de llaves hex



No.	mm	size / rozmiar	pcs	box
56550	1.3; 1.5; 2; 2.5; 3; 3.5; 4; 5; 5.5; 6; 7; 8; 10	1/20" (1.2 mm); 1/16" (1.6 mm); 5/64" (2.0 mm); 3/32" (2.4 mm); 7/64" (2.8 mm); 1/8" (3.2 mm); 5/32" (4.0 mm); 3/16" (4.8 mm); 7/32" (5.6 mm); 1/4" (6.3 mm); 5/16" (7.9 mm); 3/8" (9.5 mm)	25	25/50

PL Zestaw kluczy imbusowych
GB Hex key set
D Sechskant-Stiftschluselsatz
RUS Набор шестигранных с шаром

CZ Imbusové klíče
RO Chei imbus
H Imbisz kulcs
E Juego de llaves hex

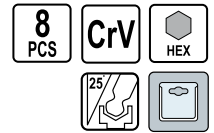

No.	mm	pcs	box
56473	1.5; 2; 2.5; 3; 4; 5; 6; 8	8	10/60

PL Zestaw kluczy imbusowych
GB Hex key set
D Sechskant-Stiftschluselsatz
RUS Набор шестигранных с шаром

CZ Imbusové klíče
RO Chei imbus
H Imbisz kulcs
E Juego de llaves hex

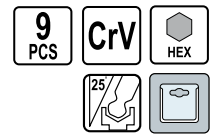

No.	mm	pcs	box
56477	2; 2.5; 3; 4; 5; 5.5; 6; 8; 10	9	10/60

PL Zestaw kluczy imbusowych
GB Hex key set
D Sechskant-Stiftschluselsatz
RUS Набор шестигранных

CZ Imbusové klíče
RO Chei imbus
H Imbisz kulcs
E Juego de llaves hex



No.	mm	pcs	box
56506	1.5; 2; 2.5; 3; 4; 5; 6; 8	8	25/100

PL Zestaw kluczy Torx
GB Torx key set
D Torx-Stiftschluselsatz
RUS Набор ключей Torx

CZ Souprava klíčů Torx
RO Set de chei Torx
H Kulcskészlet, Torx
E Juego de llaves Torx



No.	size	pcs	box
56478	T10; T15; T20; T25; T27; T30; T40; T45; T50	9	20/40

PL Zestaw kluczy Torx
GB Torx key set
D Torx-Stiftschluselsatz
RUS Набор ключей Torx

CZ Souprava klíčů Torx
RO Set de chei Torx
H Kulcskészlet, Torx
E Juego de llaves Torx



3

No.		pcs	
56600	T10-T40	8	50/100

PL Zestaw kluczy Torx
GB Torx key set
D Torx-Stiftschluselsatz
RUS Набор ключей Torx

CZ Souprava klíčů Torx
RO Set de chei Torx
H Kulcskészlet, Torx
E Juego de llaves Torx

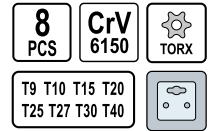

No.	pcs	
56507	8	25/100

Memo	
------	--



Memo

4

Pliers & pipe wrenches Szcypce i klucze do rur



Pliers, heavy duty blue handle
Szczypce, uchwyt niebieski

46

Combination pliers

Szczypce uniwersalne..... 46

Side cutting pliers

Szczypce tnące, boczne..... 46

Long nose pliers

Szczypce wydłużone, proste..... 46

Bent nose pliers

Szczypce wydłużone, wygięte..... 46

Pliers, 2 colour handle
Szczypce, dwukolorowa rączka

46-47

Combination pliers

Szczypce uniwersalne..... 46

Side cutting pliers

Szczypce tnące, boczne..... 46

Long nose pliers

Szczypce wydłużone, proste..... 46

Bent nose pliers

Szczypce wydłużone, wygięte..... 46

Round nose pliers

Szczypce okrągłe..... 47

Wire stripping pliers

Szczypce do ściągania izolacji..... 47

End cutting pliers

Szczypce tnące, czołowe..... 47

Water pump pliers

Szczypce nastawne..... 47

Chrome plated pliers
Szczypce chromowane

47

Water pump pliers

Szczypce nastawne..... 47

Pincers & pliers
Szczypce i obcęgi

47-48

End cutting pliers

Szczypce tnące, czołowe..... 47

Carpenter's pincers

Obcęgi..... 47

Tower pincers

Szczypce tynkarskie..... 48

Profile connection pliers
Szczypce do łączenia profili

48

Pliers „Juco”
Szczypce „Juco”

48

Combination pliers

Szczypce uniwersalne..... 48

Side cutting pliers

Szczypce tnące, boczne..... 48

Mini pliers**Szczypce „Mini”**

48-49

Combination pliers

Szczypce uniwersalne..... 48

Side cutting pliers

Szczypce tnące, boczne..... 48

Long nose pliers

Szczypce wydłużone, proste..... 48

Bent nose pliers

Szczypce wydłużone, wygięte..... 49

Flat nose pliers

Szczypce płaskie..... 49

Round nose pliers

Szczypce okrągłe..... 49

End cutting pliers

Szczypce tnące, czołowe..... 49

Mini pliers sets

Zestawy szczypiec „Mini”..... 49

Circlip pliers
Szczypce Segera

49-51

Lock grip pliers
Szczypce zaciskowe

51

Water pump pliers
Szczypce nastawne

52

Pipe wrenches
Klucze do rur

52-53

Pipe wrenches Stillson type

Klucze do rur typu Stillson..... 52

Adjustable pipe wrenches

Klucze do rur nastawne..... 52

Adjustable wrenches

Klucze nastawne francuskie..... 53

Chain pipe wrenches
Klucze do rur łańcuchowe

53

PL Szczypce uniwersalne
GB Combination pliers
D Kombinationszange
RUS Плоскогубцы универсальные

CZ Univerzální kleště
RO Patent universal
H Kombináltfogó
E Alicates universal



VOREL

No.	L (mm)	
40010	160	6/60
40011	180	6/60
40012	200	6/60

PL Szczypce wydłużone proste
GB Long nose pliers
D Radiozange
RUS Тонкогубцы

CZ Prodloužené kleště rovné
RO Patent drept alungit
H Rádiófogó, egyenes
E Alicates de punta



VOREL

No.	L (mm)	
40013	160	6/120
40014	200	6/60

PL Szczypce uniwersalne
GB Combination pliers
D Kombinationszange
RUS Плоскогубцы универсальные

CZ Univerzální kleště
RO Patent universal
H Kombináltfogó
E Alicates universal



VOREL

No.	L (mm)	
40041	160	6/60
40042	180	6/60
40043	200	6/60

PL Szczypce wydłużone proste
GB Long nose pliers
D Radiozange
RUS Тонкогубцы

CZ Prodloužené kleště rovné
RO Patent drept alungit
H Rádiófogó, egyenes
E Alicates de punta



VOREL

No.	L (mm)	
40044	160	6/120
40045	180	6/60

PL Szczypce tnące boczne
GB Diagonal side cutting pliers
D Seitenschneider
RUS Бокорезы

CZ Řezací kleště boční
RO Patent de tăiat lateral
H Oldal csípőfogó
E Alicates corte lateral



VOREL

No.	L (mm)	
40017	160	6/60
40018	180	6/60

PL Szczypce wydłużone wygięte
GB Bent nose pliers
D Telefonzange
RUS Тонкогубцы изогнутые

CZ Prodloužené kleště ohnuté
RO Patent curbát alungit
H Rádió- és telefonfogó, hajlított
E Alicates curvos



VOREL

No.	L (mm)	
40015	160	6/120
40016	200	6/60

PL Szczypce tnące boczne
GB Diagonal side cutting pliers
D Seitenschneider
RUS Бокорезы

CZ Řezací kleště boční
RO Patent de tăiat lateral
H Oldal csípőfogó
E Alicates corte lateral



VOREL

No.	L (mm)	
40047	160	6/120
40048	180	6/60

PL Szczypce wydłużone wygięte
GB Bent nose pliers
D Telefonzange
RUS Тонкогубцы изогнутые

CZ Prodloužené kleště ohnuté
RO Patent curbát alungit
H Rádió- és telefonfogó, hajlított
E Alicates curvos



VOREL

No.	L (mm)	
40050	160	6/120
40051	180	6/60

PL Szczypce okręgle
GB Round nose pliers
D Rundzange
RUS Круглогубцы

CZ Kruhové klešře
RO Patent rotund
H Kerekcsőrű fogó
E Alicates redondos

160 mm



No.	L (mm)	
40054	160	6/120

PL Szczypce tnące czolowe
GB End cutting pliers
D Vorschneider
RUS Кусачки торцевые

CZ Řezací klešře čelní
RO Clește de tăiat frontal
H Homlok csípőfogó
E Alicates corte frontal

160 mm



No.	L (mm)	
40055	160	6/60

PL Szczypce nastawne
GB Water pump pliers
D Wasserpumpenzange
RUS Клещи переставные

CZ Hydraulické klešře nastavitelné
RO Clește instalator tip papagal
H Állítható csőfogó
E Alicates de fontanero

250 mm



No.	L (mm)	
41500	250	6/60

PL Obcęgi
GB Carpenter's pincers
D Kneifzange
RUS Клещи строительные

CZ Klešře
RO Clește
H Harapőfogó
E Tenazas



No.	L (mm)	
41151	180	6/60
41152	200	6/60

PL Szczypce do ściągania izolacji
GB Wire stripping pliers
D Abisolierzange
RUS Клещи для снятия изоляции

CZ Klešře na sundávání izolace
RO Patent pt. decablat
H Szigeteléseltávolító fogó
E Pinzas pelacables

160 mm



No.	L (mm)	
40056	160	6/60

PL Szczypce nastawne
GB Water pump pliers
D Wasserpumpenzange
RUS Клещи переставные

CZ Hydraulické klešře nastavitelné
RO Clește instalator tip papagal
H Állítható csőfogó
E Alicates de fontanero

250 mm



No.	L (mm)	
40057	250	6/60

PL Szczypce tnące czolowe
GB End cutting pliers
D Vorschneider
RUS Кусачки торцевые

CZ Řezací klešře čelní
RO Clește de tăiat frontal
H Homlok csípőfogó
E Alicates corte frontal

180 mm



No.	L (mm)	
41121	180	6/60

PL Obcęgi
GB Carpenter's pincers
D Kneifzange
RUS Клещи строительные

CZ Klešře
RO Clește
H Harapőfogó
E Tenazas



No.	L (mm)	
41180	180	6/120
41200	200	6/60

PL Obcegi tynkarskie
GB Tower pincers
D Beisszange
RUS Клеши штукатурные

CZ Kleště štípací čelní
RO Clește pt. cuie
H Rabitzfogó
E Tenazas de enlucido

250 mm
✕



No.	L (mm)	
41381	250	6/60

PL Szczypce do łączenia profili
GB Profile connection pliers
D Zange zum Verbinden der Profile
RUS Щипцы для соединения профилей

CZ Kleště ke spojování profilů
RO Clește pt. îmbinarea profilelor
H Profilegyesítő fogó
E Pinzas para conectar perfiles

300 mm
SECTION THICKNESS GRUBOSC PROFILU 0.5-0.8 mm
☐



No.	L (mm)	
04301	300	6/24

PL Szczypce tnące boczne
GB Diagonal side cutting pliers
D Seitenschneider
RUS Бокорезы

CZ Řezací kleště boční
RO Patent de tăiat lateral
H Oldal csípőfogó
E Alicates corte lateral

1000 V
160 mm
☐



No.	L (mm)	V	
40700	160	1000	5/50

PL Szczypce tnące boczne
GB Diagonal side cutting pliers
D Seitenschneider
RUS Бокорезы

CZ Řezací kleště boční
RO Patent de tăiat lateral
H Oldal csípőfogó
E Alicates corte lateral

110 mm
☐



No.	L (mm)	
42301	110	12/120

PL Szczypce do łączenia profili
GB Profile connection pliers
D Zange zum Verbinden der Profile
RUS Щипцы для соединения профилей

CZ Kleště ke spojování profilů
RO Clește pt. îmbinarea profilelor
H Profilegyesítő fogó
E Pinzas para conectar perfiles

280 mm
SECTION THICKNESS GRUBOSC PROFILU 0.5-0.8 mm
65 Mn (PUNCH)
☐



No.	L (mm)	
04300	280	6/36

PL Szczypce uniwersalne
GB Combination pliers
D Kombinationszange
RUS Плоскогубцы универсальные

CZ Univerzální kleště
RO Patent universal
H Kombináltfogó
E Alicates universal

1000 V
☐



No.	L (mm)	V	
40160	160	1000	10/50
40180	180	1000	10/50
40200	200	1000	10/50

PL Szczypce uniwersalne
GB Combination pliers
D Kombinationszange
RUS Плоскогубцы

CZ Univerzální kleště
RO Patent universal
H Kombináltfogó
E Alicates universal

120 mm
☐



No.	L (mm)	
42300	120	12/120

PL Szczypce wydłużone proste
GB Long nose pliers
D Radiozange
RUS Тонкогубцы

CZ Prodloužené kleště rovné
RO Patent drept alungit
H Rádiófogó, egyenes
E Alicates de punta

125 mm
☐



No.	L (mm)	
42303	125	12/120

- PL Szczypce wydłużone proste CZ Prodloužené kleště rovné
 GB Long nose pliers RO Patent drept alungit
 D Radiozange H Rádiófogó, egyenes
 RUS Тонкогубцы E Alicates de punta



No.	L (mm)	
42305	150	12/120

- PL Szczypce płaskie CZ Prodloužené kleště rovné
 GB Flat nose pliers RO Clește cu vârf ascuțit
 D Elektrikerflachzange H Rádiófogó, egyenes
 RUS Утконосы E Alicates de bocas planas



No.	L (mm)	
42306	120	12/120

- PL Szczypce tnące czołowe CZ Řezací kleště čelní
 GB End cutting pliers RO Clește de tăiat frontal
 D Vorschneider H Homlok csípőfogó
 RUS Кусачки торцевые E Alicates corte frontal



No.	L (mm)	
42302	110	12/120

- PL Zestaw mini szczypiec CZ Elektronické kleště
 GB Mini pliers set RO Set mini patenti si clesiti
 D Mini-Zangensatz H Elektronikai fogó
 RUS Пассатижи в наборе E Alicates electronicas



No.	pcs	
42309	6	10/40

- PL Szczypce wydłużone wygięte CZ Prodloužené kleště ohnuté
 GB Bent nose pliers RO Patent curbát alungit
 D Telefonzange H Rádió- és telefonfogó hajlítót
 RUS Тонкогубцы изогнутые E Alicates curvos



No.	L (mm)	
42304	125	12/120

- PL Szczypce okrągłe CZ Kruhové kleště
 GB Round nose pliers RO Patent rotund
 D Rundzange H Kerekszerű fogó
 RUS Круглогубцы E Alicates redondos



No.	L (mm)	
42307	125	12/120

- PL Zestaw mini szczypiec CZ Elektronické kleště
 GB Mini pliers set RO Set mini patenti
 D Mini-Zangensatz H Elektronikai fogó
 RUS Пассатижи в наборе E Alicates electronicas



No.	pcs	
42308	4	25/50

- PL Szczypce Segera, zewnętrzne proste CZ Kleště Segera vnější rovné
 GB Circlip pliers, external straight RO Clește Seger exterior drept
 D Seegeringzange aussen. ger. H Segerfogó külső, egyenes
 RUS Съёмник стопорных колец (разжим) E Alicates Seger exter. de punta



No.	L (mm)	
43010	150	6/120
43011	200	6/120

PL Szczypce Segera, zewnętrzne wygięte
 GB Circlip pliers, external bent
 D Seegeringzange aussen. geb.
 RUS Съёмник стопорных колец (разжим)-изогнутый

CZ Kleště Segera vnější ohnuté
 RO Clește Seger exterior curbat
 H Seegerfogó külső, hajlított
 E Alicates seger exter. curvos



No.	L (mm)	
43020	150	6/120
43021	200	6/120

PL Szczypce Segera, wewnętrzne wygięte
 GB Circlip pliers, internal bent
 D Seegeringzange inner. geb.
 RUS Съёмник стопорных колец (сжим)-изогнутый

CZ Kleště Segera vnitřní ohnuté
 RO Patent seger interior curbat
 H Seegerfogó belső, hajlított
 E Alicates Seger inter. curvos



No.	L (mm)	
43040	150	6/120
43041	200	6/120

PL Szczypce Segera, zewnętrzne wygięte
 GB Circlip pliers, external bent
 D Seegeringzange aussen. geb.
 RUS Съёмник стопорных колец (разжим)

CZ Kleště Segera vnější ohnuté
 RO Clește Seger exterior curbat
 H Seegerfogó külső, hajlított
 E Alicates seger exter. curvos



VOREL

No.	L (mm)	
43051	160	6/60
43056	180	6/60
43061	200	6/60

PL Szczypce Segera, wewnętrzne wygięte
 GB Circlip pliers, internal bent
 D Seegeringzange inner. geb.
 RUS Набор съёмников стопорных колец (сжим)

CZ Kleště Segera vnitřní ohnuté
 RO Patent Seger interior curbat
 H Seegerfogó belső, hajlított
 E Alicates Seger inter. curvos



VOREL

No.	L (mm)	
43053	160	6/60
43058	180	6/60
43063	200	6/60

PL Szczypce Segera, wewnętrzne proste
 GB Circlip pliers, internal straight
 D Seegeringzange inner. ger.
 RUS Съёмник стопорных колец (сжим)

CZ Kleště Segera vnitřní rovné
 RO Clește Seger interior drept
 H Seegerfogó belső, egyenes
 E Alicates seger inter. de punta



No.	L (mm)	
43030	150	6/120
43031	200	6/120

PL Szczypce Segera, zewnętrzne proste
 GB Circlip pliers, external straight
 D Seegeringzange aussen. ger.
 RUS Съёмник стопорных колец (разжим)

CZ Kleště Segera vnější rovné
 RO Clește Seger exterior drept
 H Seegerfogó külső, egyenes
 E Alicates Seger exter. de punta



VOREL

No.	L (mm)	
43050	160	6/60
43055	180	6/60
43060	200	6/60

PL Szczypce Segera, wewnętrzne proste
 GB Circlip pliers, internal straight
 D Seegeringzange inner. ger.
 RUS Набор съёмников стопорных колец (сжим)

CZ Kleště Segera vnitřní rovné
 RO Clește Seger interior drept
 H Seegerfogó belső, egyenes
 E Alicates seger inter. de punta



VOREL

No.	L (mm)	
43052	160	6/60
43057	180	6/60
43062	200	6/60

PL Szczypce Segera
 GB Circlip pliers set
 D Seegeringzangen Satz
 RUS Набор съёмников стопорных колец

CZ Kleště Segera
 RO Set clești seger
 H Seegerfogó
 E Alicates seger



No.	L (mm)	pcs	
43140	150	4	5/30

PL Szczypce Segera
 GB Circlip pliers set
 D Seegeringzangen Satz
 RUS Съёмник стопорных колец
 CZ Kleště Segera
 RO Cleste pt. inele de siguranta + capete de schimb
 H Segerfogó
 E Alicates seger



No.	L (mm)	pcs	Box
43500	150	4	6/60

PL Szczypce Morse'a
 GB Lock grip pliers
 D Gripzange
 RUS Зажим ручной

CZ Kleště Morse'a
 RO Clește Morse
 H Morse fogó
 E Alicates Morse



No.	L (mm)	Box
44100	250	6/60

PL Szczypce spawalnicze
 GB Lock grip pliers
 D Schweisserzange
 RUS Клещи зажимные сварочные

CZ Svářečské kleště
 RO Cleste autoblocant pt. sudura
 H Hegesztő fogó
 E Alicates de soldar

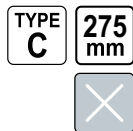

No.	L (mm)	type	Box
44300	275	C	6/36

PL Szczypce spawalnicze
 GB Lock grip pliers
 D Schweisserzange
 RUS Клещи зажимные сварочные

CZ Svářečské kleště
 RO Cleste autoblocant pt. sudura
 H Hegesztő fogó
 E Alicates de soldar



No.	L (mm)	type	Box
44400	225	W	6/36

PL Szczypce Segera
 GB Circlip pliers set
 D Seegeringzangen Satz
 RUS Съёмник стопорных колец

CZ Kleště Segera
 RO Cleste pt. inele de siguranta + capete de schimb
 H Segerfogó
 E Alicates seger



No.	L (mm)	pcs	Box
43510	150	5	6/60

PL Szczypce Morse'a
 GB Lock grip pliers
 D Gripzange
 RUS Зажим ручной

CZ Kleště Morse'a
 RO Clește Morse
 H Morse fogó
 E Alicates Morse



No.	L (mm)	Box
44102	250	6/36

PL Szczypce zaciskowe klamrowe typu „C”
 GB Welding locking pliers „C” type
 D Klemm- und Klammerzange vom Typ „C”
 RUS Клещи зажимные сварочные
 CZ Kleště samosvorné upínací typu „C”
 RO Clește de strângere cu clemă tip „C”
 H „C” fogó
 E Pinzas de tornillo (de apriete) de grapa tipo „C”



No.	L (mm)	type	Box
44301	280	C	6/30

PL Szczypce spawalnicze
 GB Lock grip pliers
 D Schweisserzange
 RUS Клещи зажимные сварочные

CZ Svářečské kleště
 RO Cleste autoblocant pt. sudura
 H Hegesztő fogó
 E Alicates de soldar



No.	L (mm)	type	Box
44500	250	SM	6/36

PL Szczypce hydrauliczne nastawne CZ Keleşte siko
 GB Water pump pliers RO Cleste papagal
 D Wasserpumpenzange H Vízpumpafagó
 RUS Ключи переставные E Alicates de fontanero ajustables



No.	L (mm)	jaw width / szerokość szczęk (mm)	
41510	250	9	10/50

PL Klucz do rur CZ Klíč součásti na trubky
 GB Pipe wrench RO Cheie pt. țevi
 D Rohrschlüssel H Csőkulcs
 RUS Ключ трубный E Llave de fontanero



No.	L (mm)	
55620	200	6/36
55625	250	6/30
55630	300	6/36
55635	350	6/24
55645	450	4/16
55660	600	2/6
55690	900	2/6

PL Klucz nastawny do rur CZ Nastawitný klíč na trubky
 GB Adjustable pipe wrench RO Cheie reglabilă pt. țevi
 D Rohrschlüssel H Állítható csőkulcs
 RUS Ключ трубный E Llave de vaso para tubería



No.	size / rozmiar	
55210	1.0" (25 mm)	24
55211	1.5" (38 mm)	16
55212	2.0" (50 mm)	8

PL Klucz nastawny do rur CZ Nastawitný klíč na trubky
 GB Adjustable pipe wrench RO Cheie reglabilă pt. țevi
 D Rohrschlüssel H Állítható csőkulcs
 RUS Ключ трубный E Llave de vaso para tubería



PL Klucz do rur CZ Klíč součásti na trubky
 GB Pipe wrench RO Cheie pt. țevi
 D Rohrschlüssel H Csőkulcs
 RUS Ключ трубный E Llave de fontanero



No.	L (mm)	
55250	250	6/48
55300	300	6/36
55350	350	6/24

PL Klucz nastawny do rur CZ Nastawitný klíč na trubky
 GB Adjustable pipe wrench RO Cheie reglabilă pt. țevi
 D Rohrschlüssel H Állítható csőkulcs
 RUS Ключ трубный E Llave de vaso para tubería



No.	size / rozmiar	
55100	1.0" (25 mm)	12/36
55150	1.5" (38 mm)	10/20
55200	2.0" (50 mm)	6/12

PL Klucz nastawny do rur CZ Nastawitný klíč na trubky
 GB Adjustable pipe wrench RO Cheie reglabilă pt. țevi
 D Rohrschlüssel H Állítható csőkulcs
 RUS Ключ трубный E Llave de vaso para tubería



No.	size / rozmiar	
55215	1.0" (25 mm)	24
55216	1.5" (38 mm)	16
55217	2.0" (50 mm)	8



No.	size / rozmiar	
55220	1.0" (25 mm)	24
55221	1.5" (38 mm)	16
55222	2.0" (50 mm)	8

PL Klucz nastawny francuski
 GB Adjustable wrench
 D Stahlschraubenschlüssel /franzose/
 RUS Ключ разводной

CZ Nastavitelný klíč francouz
 RO Cheie reglabilă franceză
 H Állítható francia kulcs
 E Llave ajustable inglesa



No.	KNF	jaws range / zakres szczęk (mm)	jaws width / szerokość szczęk (mm)	
54499	45	0-45	80	10
54500	55	0-55	90	5
54510	65	0-65	100	5

PL Klucz łańcuchowy do rur
 GB Chain pipe wrench
 D Kettenrohrzange
 RUS Цепной ключ для труб

CZ Klíč řetězový na trubky
 RO Cheie reglabilă pt. tevi cu lanț
 H Láncos csőfogó
 E Llave de cadena

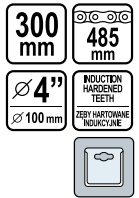

No.	L (mm)	max. pipe diameter / max. średnica rury	
55792	300	4" (100 mm)	10/30

4

Memo

5

Electrician tools Narzędzia dla elektryków

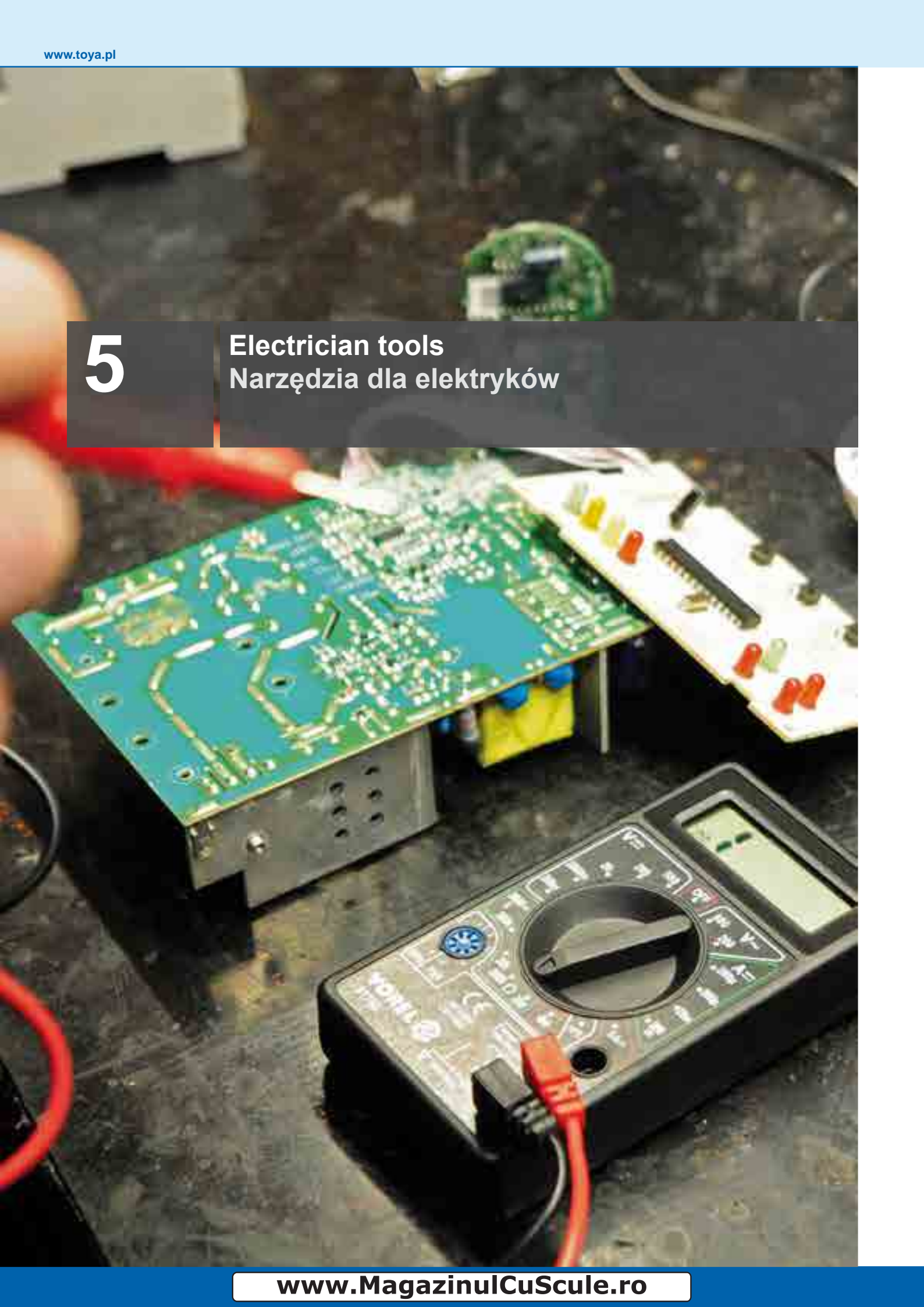

Crimping pliers
Szczypce do zaciskania
konektorów

56



Ratchet crimping pliers
Szczypce do zaciskania
konektorów z grzechotką

56



Wire strippers
Ściągacze izolacji

56-57



Electrical cutters
Obcinaki elektryczne

57



Voltage testers
Próbniki napięcia

57



Digital universal meters
Cyfrowe mierniki uniwersalne

57



5

- PL Szczypce do zaciskania konektorów
- GB Ratchet crimping pliers
- D Kabelschuhzange
- RUS Инструмент для обжима и зачистки проводов
- CZ Kleště pro svěrání zaciskania konektorů
- RO Clește sertizat conectori
- H Krimpelő fogó
- E Pinzas de apretar de conectores



No.	mm ²		AWG		Box
	mm ²	AWG	mm ²	AWG	
45500	0.5-2.5	20-14			12/36

- PL Szczypce do zaciskania konektorów
- GB Ratchet crimping pliers
- D Kabelschuhzange
- RUS Электронпассатижи
- CZ Kleště pro svěrání zaciskania konektorů
- RO Clește sertizat conectori
- H Krimpelő fogó
- E Pinzas de apretar de conectores

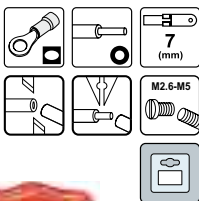

No.	mm ²		AWG		Box
	mm ²	AWG	mm ²	AWG	
45000	1.5-6.0	22-10	0.75-6.0	22-10	12/120

- PL Automatyczny ściągacz izolacji
- GB Wire stripper / crimper
- D Automatische Abisolierzange
- RUS Клещи-автомат для снятия изоляции
- CZ Automatický stahovač izolace
- RO Decablator automat
- H Automatikus szigeteléslehúzó
- E Pelacables automatico

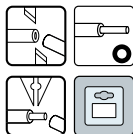

No.	mm ²		AWG		Box
	mm ²	AWG	mm ²	AWG	
45100	0.5-6.0	20-10			20/100

- PL Automatyczny ściągacz z obcinakiem
- GB Automatic wire stripper with cutter
- D Automatische Abisolierzange + Schneider
- RUS Клещи-автомат для снятия изоляции
- CZ Automatický stahovač izolace
- RO Decablator automat
- H Automatikus szigeteléslehúzó
- E Pelacables automatico

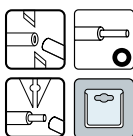

No.	mm ²		AWG		Box
	mm ²	AWG	mm ²	AWG	
45201	0.5-4.0	20-13			10/50

- PL Szczypce do zaciskania konektorów
- GB Ratchet crimping pliers
- D Kabelschuhzange
- RUS Пассатижи для телефонных кабелей
- CZ Kleště pro svěrání zaciskania konektorů
- RO Clește sertizat conectori
- H Krimpelő fogó
- E Pinzas de apretar de conectores

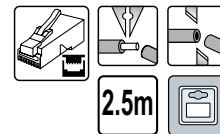

No.	mm ²		AWG		Box
	mm ²	AWG	mm ²	AWG	
45503					10/40

- PL Zaciskacz z konektorami w kasce
- GB Solderless terminal kit
- D Kabelschuhzange u. Kabelschuhe
- RUS Клещи для обжима + изолированные наконечники
- CZ Svěrka z konektorama v kazetě
- RO Set cleste mufare plus conectori
- H Présszerszám csatlakozókkal egy dobozban
- E Apretador con conectores en caja

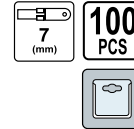
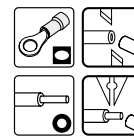

No.	mm ²		AWG		pcs	Box
	mm ²	AWG	mm ²	AWG		
45050	1.5-6.0	22-10	1.5-6.0	22-10	100	25/50

- PL Automatyczny ściągacz izolacji
- GB Wire stripper / crimper
- D Automatische Abisolierzange
- RUS Клещи-автомат для снятия изоляции
- CZ Automatický stahovač izolace
- RO Decablator automat
- H Automatikus szigeteléslehúzó
- E Pelacables automatico

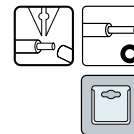

No.	mm ²		AWG		Box
	mm ²	AWG	mm ²	AWG	
45151	1.0-3.2	17-12			10/50

- PL Ściągacz izolacji
- GB Wire stripper
- D Abisolierzange
- RUS Съёмник изоляции
- CZ Odizolovací klejte
- RO Decablator
- H Blankolo fogo
- E Extractor de aislado

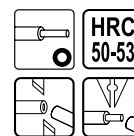

No.	mm ²		AWG		Box
	mm ²	AWG	mm ²	AWG	
45010	0.8-2.6	22-10			12/120

- PL Ściągacz izolacji
GB Wire stripper
D Abisolierzange
RUS Электрорассчитки
- CZ Odizolovací klejte
RO Decablator
H Blankolo fogo
E Extractor de aislado

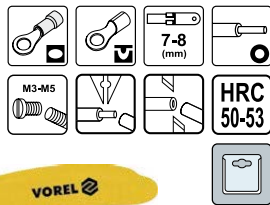

No.	□		□		○		📦
	mm ²	AWG	mm ²	AWG	mm ²	AWG	
45012	0.64-2.6	26-10	0.8-2.6	22-10	0.64-2.6	26-10	12/72

- PL Nożyczki dla elektryków
GB Electrician scissors
D Elektrische Schere
RUS Ножницы электрика
- CZ Univerzální nůžky
RO Foarfece universal
H Univerzális olló
E Tijeras universales



No.	L (mm)	📦
76320	140	12/120

- PL Próbnik napięcia
GB Voltage tester
D Spannungsprüfer
RUS Отвёртка индикаторная
- CZ Zkoušeč napětí
RO Creion de tensiune
H Fáziskereső
E Comprobador de corriente



No.	L (mm)	📦
65235	190	12/600

- PL Cyfrowy miernik uniwersalny
GB Digital universal multimeter
D Universal digital Multimeter
RUS Универсальный цифровой мультиметр
- CZ Digitální multimetr - univerzální
RO Multimetru digital universal
H Digitális multiméter
E Manómetor digital universal

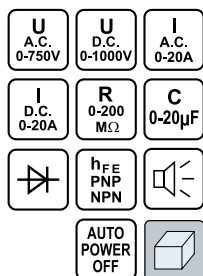

No.	digit height / wysokość cyfr (mm)	📦
81783	25	20

- PL Obcinak elektryczny
GB Electrical cutter
D Seitenschneider
RUS Щипцы для резки проводов

- CZ Elektrické upichovky ze stahovadlem
RO Clește tăietor - electrician
H Kábelvágó
E Cortacables eléctricos



No.	L (mm)	📦
45020	135	12/120

- PL Próbnik napięcia
GB Voltage tester
D Spannungsprüfer
RUS Отвёртка индикаторная
- CZ Zkoušeč napětí
RO Creion de tensiune
H Fáziskereső
E Comprobador de corriente



No.	L (mm)	📦
65233	140	12/1200

- PL Cyfrowy miernik uniwersalny
GB Digital universal multimeter
D Universal digital Multimeter
RUS Универсальный цифровой мультиметр
- CZ Digitální multimetr - univerzální
RO Multimetru digital universal
H Digitális multiméter
E Manómetor digital universal

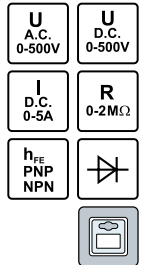

No.	📦
81780	12/72

- PL Cyfrowy miernik uniwersalny
GB Digital universal multimeter
D Universal digital Multimeter
RUS Универсальный цифровой мультиметр
- CZ Digitální multimetr - univerzální
RO Multimetru digital universal
H Digitális multiméter
E Manómetor digital universal

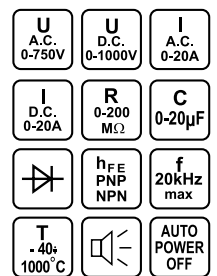

No.	digit height / wysokość cyfr (mm)	📦
81784	25	20

6

Hammers, chisels, punches & axes Młotki, dłuta, przecinaki i siekiery



Machinist hammers Młotki ślusarskie



60-61

Machinist hammers with wooden handle

Młotki ślusarskie z rączką drewnianą..... 60

Machinist hammers with fibreglass handle

Młotki ślusarskie z rączką z włókna szklanego..... 60

Machinist hammers „Juco”

Młotki ślusarskie „Juco”..... 60

Brick hammers „Juco”

Młotki murarskie „Juco”..... 61

Welder's hammers „Juco”

Młotki spawalnicze „Juco”..... 61

Stoning hammers Młotki kamieniarskie



61

Stoning hammers „Juco”

Młotki kamieniarskie „Juco”..... 61

Hammers with tubular steel handle Młotki z trzonkiem rurowym



61-62

Claw hammers

Młotki szewskie..... 61

Roofing hammers

Młotki ciesielskie..... 61

Mason's hammers

Młotki murarskie..... 62

Hammers with fibreglass handle Młotki z rączką z włókna szklanego



62

Claw hammers

Młotki szewskie..... 62

Roofing hammers

Młotki ciesielskie..... 62

Rubber mallets Młotki gumowe



62-63

Rubber mallets with wooden handle

Młotki gumowe z rączką drewnianą..... 62

Rubber mallets with tubular steel handle

Młotki gumowe z rączką stalową..... 62

Rubber mallets with fibreglass handle

Młotki gumowe z rączką z włókna szklanego..... 62

Soft faced mallets

Młotki blacharskie gumowo-plastykowe..... 63

Wooden mallets Młotki drewniane



63

Chisels, cold chisels, punches & wrecking bars

Dłuta, przecinaki, przebijaki i łomy



63-65

Wood chisels with wooden handle

Dłuta stolarskie z rączką drewnianą..... 63

Wood chisels with plastic handle

Dłuta stolarskie z rączką z tworzywa..... 63

Curving chisels

Dłuta snycerskie..... 63

Cold chisels

Przecinaki..... 64

Cold chisels „Juco”

Przecinaki „Juco”..... 64

Punches

Przebijaki..... 64

Wrecking bars

Łomy..... 64

Wrecking bars „Juco”

Łomy „Juco”..... 65

Axes Siekiery



65-67

Axes with wooden handle

Siekiery z trzonkiem drewnianym..... 65

Axes with fibreglass handle

Siekiery z trzonkiem z włókna szklanego..... 66

Axes „Juco”

Siekiery „Juco”..... 66

Hammer and axe wedges

Zestawy klinujące do młotków i siekier..... 67

Picaxes Kilofy



67

Pickaxes

Kilofy..... 67

Wood splitters „Juco”

Kliny do rozłupywania drewna „Juco”..... 67

PL Młotek ślusarski
GB Machinist hammer
D Schlosserhammer
RUS Молоток слесарный

CZ Zámečnické kladívko
RO Ciocan de lăcătușerie
H Vaskalapács
E Martillo



No.	g	
30010	100	12/120
30020	200	12/72
30030	300	12/60
30040	400	6/48
30050	500	6/36
30060	600	6/36
30080	800	6/24
30100	1000	6/24
30150	1500	6/12
30200	2000	6/12

PL Młotek ślusarski
GB Machinist hammer
D Schlosserhammer
RUS Молоток слесарный

CZ Zámečnické kladívko
RO Ciocan de lăcătușerie
H Vaskalapács
E Martillo

DIN 1042



No.	kg	
30531	3	1
30532	4	1
30533	5	1
30534	6	1
30535	8	1
30536	10	1

PL Młotek ślusarski
GB Machinist hammer
D Schlosserhammer
RUS Молоток слесарный

CZ Zámečnické kladívko
RO Ciocan de lăcătușerie
H Vaskalapács
E Martillo

DIN 1041



JUCO

No.	kg	
31010	0.1	10
31030	0.3	10
31050	0.5	10
31070	0.7	10
31100	1.0	10
31150	1.5	6
31200	2.0	6

PL Młotek ślusarski
GB Machinist hammer
D Schlosserhammer
RUS Молоток слесарный

CZ Zámečnické kladívko
RO Ciocan de lăcătușerie
H Vaskalapács
E Martillo



VOREL

No.	g	
30410	100	12/120
30420	200	6/60
30430	300	6/60
30440	400	6/48
30450	500	6/36
30460	600	6/36
30480	800	6/24
30500	1000	6/24
30510	1500	6/12
30520	2000	6/12

PL Młotek ślusarski, rączka z włókna szklanego
GB Machinist hammer with fibreglass + PVC handle
D Schlosserhammer Fibreglasstiel
RUS Молоток со стеклопластиковой ручкой

CZ Zámečnické kladívko
RO Ciocan de lăcătușerie
H Vaskalapács
E Martillo



VOREL

No.	g	
30310	100	6/120
30320	200	6/36
30330	300	6/48
30340	400	6/36
30350	500	6/36
30360	600	6/36
30380	800	6/24
30390	1000	6/24
30395	1500	6/12
30400	2000	6/12

PL Młotek ślusarski
GB Machinist hammer
D Schlosserhammer
RUS Молоток слесарный

CZ Zámečnické kladívko
RO Ciocan de lăcătușerie
H Vaskalapács
E Martillo

DIN 1042



JUCO

No.	kg	
31300	3.0	1
31400	4.0	1
31500	5.0	1
31600	6.0	1
31800	8.0	1
32000	10.0	1

PL Młotek ślusarski
GB Machinist hammer
D Schlosserhammer
RUS Молоток слесарный

CZ Zámečnické kladívko
RO Ciocan de lăcătuşerie
H Vaskalapács
E Martillo

DIN 1041



JUJO

No.	g	
29992	300	5
29993	500	5
29994	700	5
29995	1000	5
29996	1500	5
29997	2000	5

PL Młotek spawalniczy
GB Welder's hammer
D Schweisserhammer
RUS Молоток сварщика

CZ Svářečské kladívko
RO Ciocan de sudură
H Hegesztő kalapács
E Martillo para soldar



JUJO

No.	g	
32110	350	5

PL Młotek szewski, rączka ze stali
GB Claw hammer with tubular steel handle
D Klauenhammer
RUS Молоток-гвоздодер с металлической обрезиненной рукояткой

CZ Ševcovské kladívko
RO Ciocan de cizmărie
H Cipész kalapács
E Martillo sacador mango de acero



VOREL

No.	g	
32625	600	6/24

PL Młotek murarski
GB Brick hammer
D Maurerhammer
RUS Молоток каменщика

CZ Zednické kladívko
RO Ciocan de zidărie
H Kőműves kalapács
E Martillo albañil



JUJO

No.	g	
32720	700	5

PL Młotek kamieniarski
GB Safety stoning hammer
D Fäustel
RUS Кувалда двухобуховая

CZ Palička kovová
RO Ciocan pt. zidarie
H Kőtörő kalapács
E Martillo

DIN 6475



JUJO

No.	kg	
32201	1.5	6
32202	2.0	6
32203	3.0	1
32204	4.0	1
32205	5.0	1
32206	6.0	1
32207	8.0	1
32208	10.0	1

PL Młotek ciesielski, rączka ze stali
GB Roofing hammer with tubular steel handle
D Lattenhammer
RUS Молоток кровельщика

CZ Tesařské kladívko
RO Ciocan de dulgherie
H Ácskalapács
E Martillo sacador mango de acero



VOREL

No.	g	
32685	600	6/24

- PL Młotek murarski berliński, rączka ze stali
 GB Mason's hammer type „B” with tubular steel handle
 D Berliner Mauerhammer
 RUS Молоток каменщика
- CZ Zednické kladívko berlińské
 RO Ciocan de zidărie tip Berlin
 H Kőműves kalapács, berlini típus
 E Martillo berlin mango de acero



No.	g	
32705	600	6/24

- PL Młotek szewski, rączka z włókna szklanego
 GB Claw hammer with fibreglass + PVC handle
 D Klauenhammer Fiberglasstiel
 RUS Молоток-гвоздодер со стеклопластиковой ручкой
 CZ Kladívko ševcovské, ručka ze skleněných vláken
 RO Cican pt. cismari, cu mânier din fibră de sticlă
 H Cipész kalapács
 E Martillo sacador con mango de fibra de vidrio



No.	g	
32627	600	6/24

- PL Młotek gumowy
 GB Rubber mallet
 D Gummihammer
 RUS Киянка резиновая
- CZ Pryžové kladívko
 RO Ciocan de cauciuc
 H Gumikalapács
 E Mazo de goma



No.	mm	
33550	45	36/72
33650	55	12/60
33900	70	12/24

- PL Młotek gumowy, rączka z włókna szklanego
 GB Rubber mallet with fibreglass + PVC handle
 D Gummihammer Fiberglasstiel
 RUS Киянка резиновая с фиберглассовой ручкой
- CZ Pryžové kladívko
 RO Ciocan de cauciuc
 H Gumikalapács
 E Mazo de goma



- PL Młotek murarski reński, rączka ze stali
 GB Mason's hammer type „R” with tubular steel handle
 D Mauerhammer rheinische Form
 RUS Молоток каменщика
- CZ Zednické kladívko reńské
 RO Ciocan de zidărie
 H Kőműves kalapács, rajnai típus
 E Martillo rin mango de acero



No.	g	
32715	600	6/24

- PL Młotek ciesielski, rączka z włókna szklanego
 GB Roofing hammer with fibreglass + PVC handle
 D Lattenhammer Fiberglasstiel
 RUS Молоток кровельщика
 CZ Kladívko tesařské, ručka ze skleněných vláken
 RO Ciocan de dulgherie
 H Ácskalapács
 E Martillo de carpintero con mango de fibra de vidrio



No.	g	
32687	600	6/24

- PL Młotek gumowy z rączką stalową
 GB Rubber mallet with steel handle
 D Gummihammer Stahlstiel
 RUS Киянка резиновая
- CZ Pryžové kladívko
 RO Ciocan de cauciuc
 H Gumikalapács
 E Mazo de goma



No.	mm	
33557	50	6/60
33657	56	12/48
33907	66	6/24
33927	76	6/24



No.	mm	
33535	45	6/48
33555	50	6/48
33655	56	6/30
33905	66	6/24
33925	76	6/24

PL Młotek blacharski, guma - plastik
 GB Soft faced mallet
 D Ausbeulhammer
 RUS Молоток рихтовочный комбинированный с деревянной ручкой

CZ Klempířské kladívko
 RO Ciocan pt. tabla
 H Bádogos kalapács
 E Mazo goma-plastico



No.	mm	
33950	35	30/60

PL Młotek drewniany blacharski
 GB Wooden mallet
 D Holzhammer für Bleche
 RUS Молоток жестящика, деревянный

CZ Palice dřevěná klempířská
 RO Ciocan din lemn de tinichigiu
 H Bádogos fakalapács
 E Martillo de madera de hojalatero



No.	mm	
33532	285	20

PL Dłuto
 GB Chisel
 D Stechbeitel
 RUS Стамеска с ударной головкой

CZ Řezbářské dláto
 RO Dalță de tâmplărie
 H Asztalos véső
 E Cinceles con mango transparente



No.	mm	
25510	6	5/100
25511	8	5/100
25512	10	5/100
25513	12	5/100
25514	14	5/100
25515	15	5/100
25516	18	5/100
25517	20	5/100
25518	22	5/100
25519	25	5/100
25520	32	5/100
25521	38	5/100

PL Młotek drewniany stolarski
 GB Carpenter's wooden mallet
 D Tischlerhammer aus Holz
 RUS Молоток деревянный столярный

CZ Palice dřevěná stolařská
 RO Ciocan din lemn de tâmplar
 H Asztalos fakalapács
 E Martillo de madera de carpintero

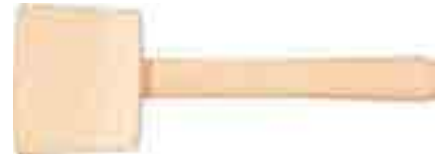

No.	mm	
33530	320	20

PL Zestaw dłut stolarskich
 GB Wood chisel set
 D Stech-Beitelsatz
 RUS Набор стамесок

CZ Zámečnické dláta
 RO Dalte de tâmplărie
 H Asztalos véső
 E Cinceles de carpintero



No.	pcs	
25500	4	10/40

PL Zestaw dłut do drewna
 GB Wood chisel set
 D Stechbeitelsatz
 RUS Набор стамесок по дереву
 CZ Zámečnické dláta
 RO Set dalți
 H Asztalos véső
 E Juego de cinceles



No.	mm	pcs	
25530	6; 12; 18; 24	4	10/40

PL Zestaw dłut snycerskich
 GB Curving chisel set
 D Holzschnittwerkzeugsatz
 RUS Набор фигурных стамесок для резьбы по дереву

CZ Řezbářské dláta
 RO Dalte curbate cu mâner din lemn
 H Finom véső
 E Cinceles mango de madera



No.	pcs	
25700	6	15/60

PL Przecinak płaski z osłoną
GB Octagonal cold chisel with protection
D Flachmeissel mit Handschutz
RUS Зубило с протектором

CZ Plochý sekáč /z krytem/
RO Dalta zidarie cu protectie
H Hidegvágó, lapos /védőfejjel/
E Cincel plano /con protector/



No.	L (mm)	
35250	250	12/72
35300	300	12/48

6

PL Przecinak ślusarski
GB Forged cold chisel
D Flachmeissel
RUS Зубило слесарное

CZ Zámečnický sekáč
RO Dalta forjata pt. metal
H Lakatos hidegvágó
E Cincel de cerrajería



JUCO

No.	thickness / grubość (mm)	width / szerokość (mm)	L (mm)	weight / waga (kg)	
35372	10	20	200	0.25	10
35373	12	23	250	0.46	10
35374	12	23	300	0.53	10
35376	10	30	400	0.90	10

PL Przecinak murarski z osłoną
GB Forged cold chisel with protection
D Meissel mit Handschutz
RUS Зубило с протектором

CZ Zámečnický sekáč /z krytem/
RO Dalta forjata cu protectie
H Fém hidegvágó, kézvédővel
E Cincel de cerrajería mm con protector

PVC HANDLE
REKOJEŚĆ Z PCV



JUCO

No.	thickness / grubość (mm)	L (mm)	weight / waga (kg)	
35359	17	250	0.56	5
35360	17	300	0.65	5
35362	17	350	0.76	5
35364	19	400	1.00	5
35366	19	450	1.13	5
35368	19	500	1.22	5

PL Łom płaski hartowany
GB Flat wrecking bar
D Nageleisen gehärtete Spitze
RUS Лом плоский закаленный

CZ Páčidlo ploché kalené
RO Ranga plata
H Lapos feszítővas
E Palanqueta



VOREL

No.	mm	
34251	450x6x35	6/24

PL Przecinak z osłoną
GB Cold chisel with protection
D Flachmeissel mit Handschutz
RUS Зубило с протектором

CZ Sekáč /z krytem/
RO Dalta cu protectie
H Hidegvágó /védőfejjel/
E Cincel /con protector/



VOREL

No.	mm	
35351	25x300	12/36
35352	25x350	10/30
35353	25x400	12/24
35355	25x500	5/20

PL Przebijak murarski z osłoną
GB Octagonal point chisel with protection
D Spitzmeissel mit Handschutz
RUS Керн с протектором

CZ Sekáč zednický s ochranným
RO Dorn cu protectie pt. constructii
H Falvész kézvédővel
E Cincel de cerrajería con protector

300 mm



No.	L (mm)	
35430	300	12/48

PL Łom
GB Wrecking bar
D Nageleisen
RUS Лом

CZ Páčidlo
RO Ranga
H Szögkihúzó
E Palanqueta

HEX



VOREL

No.	mm	
34243	500x18	10
34245	700x18	10
34247	1000x18	10

PL Łom kwadratowy, hartowane końcówki
GB Square type wrecking bar
D Nageleisen gehärtete Spitze
RUS Лом квадратный с закаленными концами

CZ Páčidlo hranaté, kalené konce
RO Ranga patrata
H Négyyszög keresztmetszetű feszítővas, edzett véggel
E Palanqueta



VOREL

No.	mm	
34254	400x22x12	12/24
34256	600x30x16	6/12

PL Łom
GB Wrecking bar
D Nagelisen
RUS Лом-гвоздодёр

CZ Páčidlo
RO Ranga pt. scos cuie
H Szögkihúzó
E Palanqueta



No.	L (mm)	
34300	300	60

PL Łom sześciokątny
GB Wrecking bar
D Brechstange
RUS Лом-гвоздодёр шестигранный

CZ Šestiúhelní páčidlo
RO Ranga pt. scos cuie Profi
H Hatszögű feszítővas
E Palanqueta



JICO

No.	thickness / grubość (mm)	L (mm)	weight / waga (kg)	
34204	17	400	0.82	5
34205	17	500	1.10	5
34206	17	600	1.20	5
34207	17	700	1.40	5
34208	17	800	1.60	5
34210	19	1000	2.50	5
34212	19	1200	3.00	5

PL Siekiera ze stali kutej
GB Drop forged hatchet
D Handbeil
RUS Топор кованый

CZ Sekera ocelová kovaná
RO Toporisca lama forjata
H Kovácsolt acél fejjsze
E Hacha de metalo forjado



FLO

No.	kg	
33080	0.8	12/24

PL Siekiera
GB Axe
D Handbeil
RUS Топор с фиберглассовой ручкой

CZ Sekyrka
RO Toporisca
H Szekerce
E Hacha

FLO

No.	g	
33067	600	24
33087	800	20
33107	1000	12
33127	1250	12
33147	1400	12
33177	1600	12

PL Łom
GB Wrecking bar
D Nagelisen
RUS Лом-гвоздодёр

CZ Páčidlo
RO Ranga pt. scos cuie
H Szögkihúzó
E Palanqueta



No.	L (mm)	
34600	600	24
34750	750	6/12
34900	900	24

PL Łom budowlany
GB Wrecking bar
D Baubrechstange
RUS Лом круглый

CZ Stavební páčidlo
RO Ranga Profi
H Szögkihúzó
E Palanqueta de obra



JICO

No.	diameter / średnica (mm)	L (mm)	weight / waga (kg)	
34220	27	1000	3.6	1
34222	27	1200	4.8	1
34225	27	1500	5.7	1

PL Siekiera
GB Axe
D Handbeil
RUS Топор

CZ Sekyrka
RO Toporisca
H Szekerce
E Hacha



FLO

No.	kg	
32930	1.0	10



PL Siekiera, rączka z włókna szklanego
 GB Axe with fibreglass + PVC handle
 D Handbeil Fiberglasstiel
 RUS Топор строительный с фиберглассовой ручкой
 CZ Sekyrka
 RO Toporisca cu coada din fibra de sticla
 H Szekerce
 E Hacha con mango de fibra de vidrio



6



No.	g	
33065	600	20
33085	800	20
33105	1000	12
33125	1250	6

PL Siekiera CZ Sekyrka
 GB Axe RO Toporisca
 D Handbeil H Szekerce
 RUS Топор E Hacha

DIN
5131
7294



No.	kg	DIN	
33000	0.4	5131	5
33001	0.6	5131	5
33002	0.8	5131	5
33003	1.0	5131	5
33004	1.25	7294	5
33005	1.50	7294	5
33006	1.80	7294	5
33007	2.0	7294	5
33008	2.50	7294	5

PL Siekiero-mlot CZ Sekera-kladivo
 GB Hammer-axe for wood splitting RO Secure-ciocan
 D Spaltaxt H Szekerce-kalapács
 RUS Топор-колун E Hacha martillo para partir madera



No.	kg	
32927	2.1	1
32928	3.2	1

PL Siekiera CZ Sekyrka
 GB Axe RO Toporisca
 D Handbeil H Szekerce
 RUS Топор E Hacha

DIN
5131
7294



No.	kg	DIN	
33024	0.4	5131	5
33026	0.6	5131	5
33028	0.8	5131	5
33030	1.0	5131	5
33032	1.25	7294	5
33035	1.50	7294	5
33038	1.80	7294	5
33039	2.0	7294	5
33040	2.50	7294	5

PL Siekiera z klinem CZ Sekyrka
 GB Axe RO Toporisca
 D Handbeil H Szekerce
 RUS Топор-колун E Hacha



No.	kg	
32924	2	5

PL Siekiero-mlot CZ Sekera-kladivo
 GB Hammer-axe for wood splitting RO Secure-ciocan
 D Spaltaxt H Szekerce-kalapács
 RUS Топор-колун E Hacha martillo para partir madera



No.	kg	
32925	2.5	1
32926	4.0	1

PL Siekiera kanadyjska
 GB Canadian axe
 D Handbeil „Kanadische Form“
 RUS Топор канадского типа

CZ Sekera kanadská
 RO Topor canadian
 H Hosszú nyelű, hasító fejsze
 E Hacha canada

1.8 kg



JUJO

No.	kg	
33022	1.8	5

PL Zestaw klinujący
 GB Hammer wedges
 D Keilesatz
 RUS Набор клинов

CZ Sada klínků
 RO Set cultivator
 H Ékelő készlet
 E Juego de sujeción



JUJO

No.	for hammer / do mlotka (kg)	for axe / do siekiery (kg)	
99463	5-6	0.6-1.0	50
99464	8-10	1.2-2.5	50

PL Trzonek do kilofa
 GB Wooden handle for pick axe
 D Stiel für Spitzhacke
 RUS Черенок для кирки

CZ Násada na krumpáč
 RO Coada tamacop
 H Csákánynyél
 E Palo para pico

90 cm



No.	L (mm)	for / dla	
32902	90	32901	10

PL Klin do rozluptywania drewna
 GB Wood splitter
 D Spaltkeil
 RUS Кли́н для раскалывания бревен

CZ Klín na štípání polen
 RO Pana pt. lemn
 H Fahasító ék
 E Cuiña para partir madera

JUJO

No.	kg	
32922	2	1
32923	3	1

PL Zestaw klinujący
 GB Hammer wedges
 D Keilesatz
 RUS Набор клинов

CZ Sada klínků
 RO Set cultivator
 H Ékelő készlet
 E Juego de sujeción



JUJO

No.	for hammer / do mlotka (kg)	for axe / do siekiery (kg)	
99460	0.1-0.5	-	50
99461	0.7-2.0	-	50
99462	3.0-4.0	0.4	50

PL Kilof bez trzonka
 GB Pick axe
 D Spitzhacke ohne Stiel
 RUS Кирка двухсторонняя без черенка

CZ Násada na krumpáč
 RO Coada tamacop
 H Csákánynyél
 E Palo para pico

2.5 kg



VOREL

No.	kg	
32901	2.5	8

PL Kilof oprawiony
 GB Pick axe
 D Spitzhacke
 RUS Кирка двухсторонняя с черенком

CZ Krumpáč osazený
 RO Târnăcop cu coadă
 H Ékelt csákány
 E Piqueta

2.5 kg



VOREL

No.	kg	
32900	2.5	6



7

Clamps & vices Șciski i imadła



Clamps
Ściski

70-71

F-clamps & sets

Ściski stolarskie i zestawy..... 70

Quick release clamps

Ściski szybkozaciskowe..... 70

Spring clamps

Ściski sprężynowe..... 70

Corner clamps

Ściski kątowe..... 70

C-clamps

Ściski typu „C”..... 71

Ratchet floor clamps

Pasy ściągające do paneli podłogowych..... 71

Vices
Imadła

71-72

Baby vices

Imadła stołowe..... 71

Bench vices

Imadła ślusarskie..... 72

Hinged pipe vices

Imadła zaciskowe do rur..... 72

PL Ścisk stolarski
GB F-clamp
D Schraubzwinge
RUS Струбцина

CZ Truhlářské upínadlo
RO Presa lemn
H Asztales szorító
E Tornillo de apriete



VOREL

7

No.	mm	
37100	50x100	12/60
37101	50x150	12/60
37102	50x200	12/60
37103	50x250	12/60
37104	50x300	12/60
37106	80x200	10/30
37107	80x250	10/30
37108	80x300	10/20
37109	80x500	10/20
37110	120x300	10/20
37111	120x500	10
37112	120x800	10
37113	120x1000	6
37114	120x1200	6
37115	120x1500	6

PL Ścisk stolarski
GB F-clamp
D Schraubzwinge
RUS Струбцина

CZ Truhlářské upínadlo
RO Presa lemn tip „F”
H Asztales szorító
E Tornillo de apriete



No.	mm	pcs pakcing	
38150	50x150	2	10/30
38200	50x200	2	10/30

PL Ścisk sprężynowy
GB Spring clamp
D Federklemme
RUS Струбцина пружинная

CZ Pružinové upínadlo
RO Cleste presa pt. lemn
H Rúgós szorító
E Pinza



No.	mm	
38500	100	24/240
38515	150	12/120
38525	200	10/100

PL Ścisk stolarski
GB F-clamp
D Schraubzwinge
RUS Струбцина

CZ Truhlářské upínadlo
RO Presa lemn
H Asztales szorító
E Tornillo de apriete



No.	mm	
37150	50x150	12/60
37200	50x200	12/60
37250	50x250	12/60
37300	50x300	12/60
37380	80x300	15/30
37400	80x500	15/30
37430	120x300	10/20
37500	120x500	10/20
37800	120x800	10
37900	120x1000	10

PL Ścisk szybkowzasciskowy
GB Quick release clamp
D Schnellklemme
RUS Быстрозажимная струбцина

CZ Svěrka rychloupínací
RO Clemă cu prindere rapidă
H Gyors asztales szorító
E Apretador rápido



VOREL

No.	mm	max. expand range / max. zasięg rozpięcia (mm)	max. clamping range / max. zasięg ściskania (mm)	max. jaws depth / max. głębokość szczęk (mm)	
38401	150	141-312	0-152	63	12/36
38402	200	141-355	0-203	63	6/36
38403	250	141-405	0-254	63	6/30
38404	300	141-464	0-304	63	6/30
38406	400	141-555	0-406	63	6/24
38407	450	141-617	0-457	63	6/24
38408	600	141-769	0-609	63	6/18
38409	750	141-922	0-762	63	6/12

PL Ścisk stolarski kątowy
GB Corner clamp
D Gehrungszwinge
RUS Струбцина угловая

CZ Truhlářské upínadlo úhlové
RO Cleste presa colt
H Asztales szorító, sarok
E Tornillo de angulo



No.	mm	
38750	75	10/100

PL Ścisł stolarski kątowy
GB Corner clamp
D Gehrungszwinge
RUS Струбцина угловая

CZ Truhlářské upínadlo úhlové
RO Cleste presa colt
H Asztalos szorító, sarok
E Tornillo de angulo

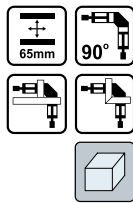

VOREL

No.	mm	
38751	65	6/12

PL Ścisli modelarskie
GB C-clamp set
D Mini-Schraubzwingensatz
RUS Набор струбцин G-типа

CZ Modelářské upínadlo
RO Presa lemn tip „C” set
H Modellező szorítók
E Tornillos tipo „C”



No.	mm	
38830	25; 50; 75	12/48

PL Imadło stolowe
GB Baby vice - fixed base
D Bankschraubstock
RUS Тиски настольные неповоротные

CZ Stolní svěrák
RO Menghină de masă
H Satu, asztali
E Tornillo de apriete



No.	mm	
36000	25	15/60
36004	40	12/48
36005	50	18/36
36006	60	12/24
36008	70	10/20

PL Ścisł typu „C”
GB C clamp
D C-Schraubzwinge
RUS Струбцина тип „G”

CZ Sverka tvaru „C”
RO Menghină tip „C”
H Pillanatszorító
E Tornillo tipo „C”



VOREL

No.	size / rozmiar (mm)	force pressure / sila nacisku (kg)	
38430	50	140	50
38431	75	190	50
38432	100	270	30
38433	125	320	20
38434	150	360	18
38435	200	390	10
38436	250	420	6

PL Pas ściągający do paneli podłogowych
GB Ratchet floor clamp
D Spanngurt für Laminatpannele /mit Hacken und Knarre/
RUS Ремень для стяжки напольных панелей

CZ Stahovací pás na podlahní panele
RO Curea elastică strâns plăci parchet
H Padlópanelhez rögzítő pánt
E Cinta tirante para placas de suelo



No.	tape / taşma L (m)	
82355	5	10/20

PL Imadło stolowe obrotowe
GB Baby vice - swivel base
D Bankschraubstock drehbar
RUS Тиски настольные поворотные

CZ Stolní svěrák otáčivý
RO Menghină rotativă de masă
H Satu, asztali, forgó
E Tornillo de apriete giratorio



No.	mm	
36014	40	12/24
36015	50	10/20
36016	60	9/18
36018	75	6/12

PL Imadło stolowe
GB Baby vice - fixed base
D Bankschraubstock
RUS Тиски настольные поворотные

CZ Stolní svěrák
RO Menghină de masă
H Satu, asztali
E Tornillo de apriete



7

VOREL

No.	mm	
36650	65	10

PL Imadło ślusarskie obrotowe
GB Bench vice - swivel base
D Schloßerschraubstock drehbar
RUS Тиски слесарные поворотные

CZ Zámečnický svěrák otáčivé
RO Menghină de lăcătuşerie rotativă
H Satu, lakatos forgó
E Tornillo de apriete giratorio



VOREL

No.	mm	
36037	100	1
36038	125	1
36039	150	1

PL Imadło ślusarskie
GB Bench vice - fixed base
D Schloßerschraubstock
RUS Тиски слесарные с наковальней

CZ Zámečnický svěrák
RO Menghină de lăcătuşerie
H Satu, lakatos
E Tornillo de apriete



VOREL

No.	mm	
36032	100	1
36033	125	1
36034	150	1

PL Imadło zaciskowe do rur
GB Hinged pipe vice
D Rohrschraubstock
RUS Тиски для труб

CZ Upínací svěrák na trubky
RO Menghină pt. țevi
H Satu, csőszorító
E Tornillo de apriete para tubos



VOREL

No.	mm	
36570	13-50	6

Memo	
------	--

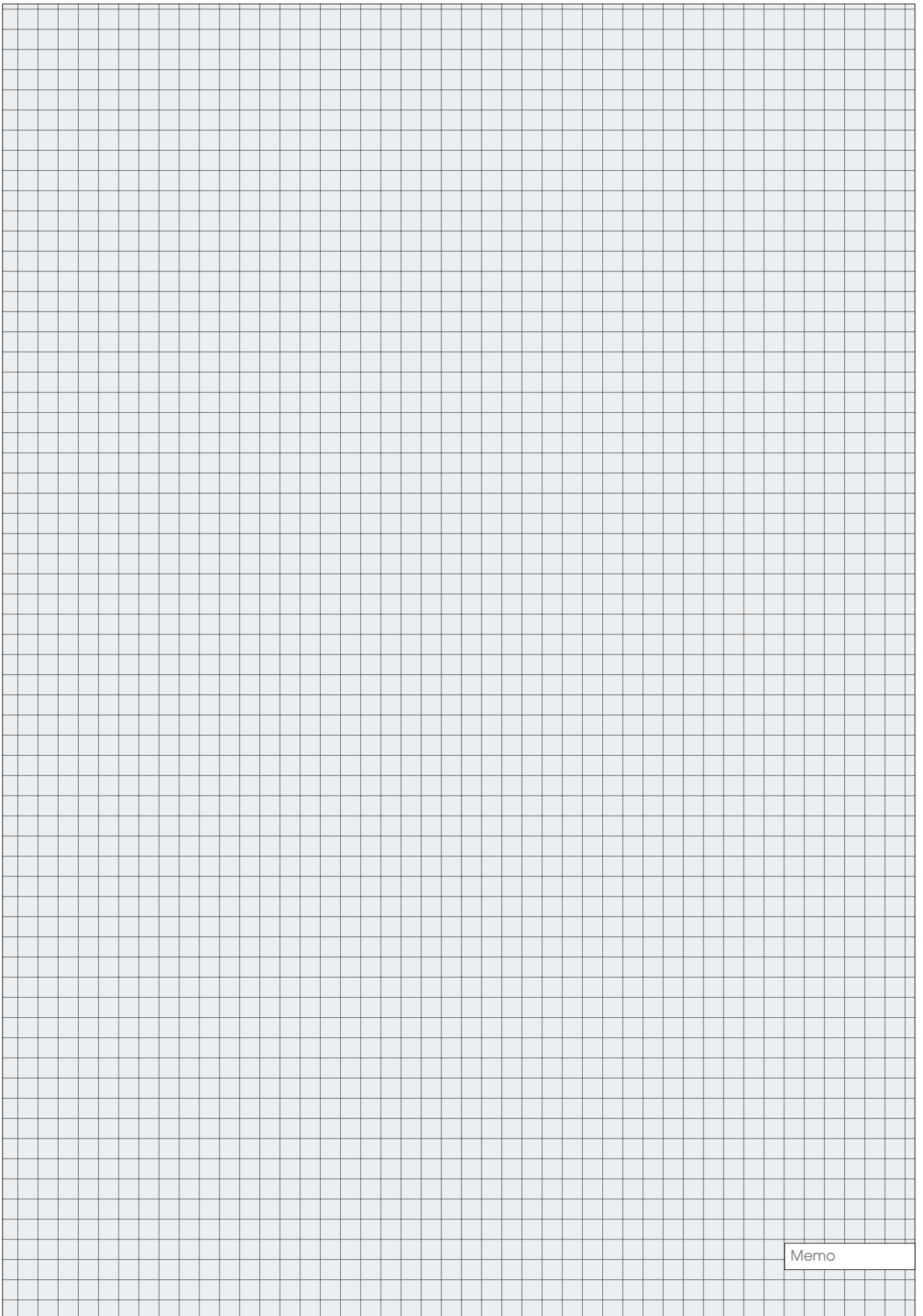

Memo

8

Cutting tools Narzędzia tnące



Drill bits Wiertła

77-83



Twist drill bits HSS & sets

Wiertła do metalu HSS i zestawy..... 77

Twist drill bits HSS-G & sets

Wiertła do metalu HSS-G i zestawy..... 78

Masonry drill bits & sets

Wiertła do betonu i zestawy..... 78

Masonry drill bits with cylindrical shank

Wiertła do betonu z uchwytem cylindrycznym..... 78

Wood drill bits

Wiertła do drewna..... 79

SDS Masonry drill bits & sets

Wiertła do betonu SDS i zestawy..... 80

SDS Chisels

Przecinaki i dłuta SDS..... 80

Hollow drill sets

Wiertła koronowe do betonu..... 82

Hole saw kits

Zestawy otwornic..... 82

Tungsten carbide hole saws

Otwornice z węglikiem wolframu..... 83

Tile and glass drill bits

Wiertła do glazury i szkła..... 83

Taps & dies

Narzędzia do gwintowania

83-85



Hand taps CZ TOOLS

Gwintowniki CZ TOOLS..... 83

Circular dies CZ TOOLS

Narzynki CZ TOOLS..... 84

Machine taps CZ TOOLS

Gwintowniki maszynowe CZ TOOLS..... 84

Tap & die sets CZ TOOLS

Zestawy gwintowników i narzynek CZ TOOLS..... 84

Tap wrenches & die holders

Pokręta do gwintowników i narzynek..... 84

Tap & die sets

Zestawy gwintowników i narzynek..... 85

Screw extractor sets

Wykrętaki do zerwanych śrub..... 85

Router bit sets

Zestawy frezów do drewna

85



Diamond tools

Narzędzia diamentowe

85-86



Diamond blades for cutting construction materials

Tarcze diamentowe do cięcia materiałów budowlanych..... 85

Diamond rod saws

Brzeszczoty diamentowe..... 86

Tungsten carbide tipped tools

Narzędzia z ostrzem z węglika wolframu

87



Tungsten carbide saws for wood

Tarcze z węglikiem do drewna..... 87

Tungsten carbide saws for aluminium

Tarcze z węglikiem do aluminium..... 87

Cutting & grinding discs

Tarcze do cięcia i szlifowania

87-88



Metal cutting discs

Tarcze do cięcia metalu..... 87

Metal grinding discs

Tarcze do szlifowania metalu..... 88

Stone cutting discs

Tarcze do cięcia kamienia..... 88

Stone grinding discs

Tarcze do szlifowania kamienia..... 88

Flap discs

Ściernice listkowe talerzowe

89



Chain discs

Tarcze łańcuchowe

89



Grinding discs

Tarcze do szlifierek stołowych

89



Shears

Nożyce

89-91



Tin snips

Nożyce do blachy..... 89

Bolt cutters

Nożyce do prętów..... 91

Saws & blades

Piły i brzeszczoty

92-96



Hand saws

Piły do drewna..... 92

Bow saws

Piły kabłąkowe..... 92

Bow saw blades

Brzeszczoty do pił kabłąkowych..... 92

Compass saws

Piły otwornice..... 92

Saws for gas concrete

Piły do gazobetonu..... 92

Hacksaw frames

Piły do metalu..... 93

Cross cut saws

Piły poprzeczne..... 93

Mitre saws

Piły kątowe..... 94

Mitre boxes

Skrzynki uciosowe..... 94

>>>

Blades
Brzeszczoty..... 95

Jig saw blades
Brzeszczoty do wyrzynarek..... 96

Brushes, knives & files

Szczotki, noże i pilniki

..... 97-108



Wire brushes
Szczotki druciane..... 97

Cup brushes
Szczotki tarczowe..... 97

Rubber discs
Tarcze gumowe do elektronarzędzi..... 99

Pocket knives
Noże składane..... 101

Window scrapers
Skrabaki do szyb..... 103

Glass cutters
Nożyki do cięcia szkła..... 103

Marking out tools
Narzędzia traserskie..... 104

Scrapers
Cykliny..... 104

Wood carving knife sets
Zestawy nożyków precyzyjnych..... 104

Scissors
Nożyczki..... 104

Leatherwork accessories
Akcesoria kaletnicze..... 105

Wood planes
Strugi..... 105

Steel files
Pilniki do metalu..... 105

Rasps
Tarniki do drewna..... 107

Rasps for plaster
Tarniki do gipsu..... 107

Abrasive products

Artykuły ściernie

.....108-111

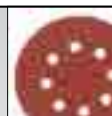

Sharpening stones
Osetki..... 108

Waterproof sand papers
Papiery ściernie wodoodporne..... 108

Abrasive clothes
Piłotna ściernie..... 109

Abrasive meshes
Siatki ściernie..... 109

No end abrasive bands
Taśmy ściernie bezkońcowe..... 109

Abrasive sponges
Kostki ściernie..... 109

Abrasive sheets and discs
Arkusze i krążki ściernie..... 110

Sanding blocks
Błoki ściernie..... 110

PL Wiertło do metalu
 GB Twist drill bit
 D Spiralbohrer
 RUS Сверло по металлу

CZ Vrták na kov
 RO Burghiu pt. metal
 H Fűrészár fémhez
 E Broca para metalo



STHOR

No.	Ø (mm)	pcs packing	Icon
20100	1.0	10	200/10000
20150	1.5	10	200/8000
20200	2.0	10	200/8000
20250	2.5	10	200/4000
20280	2.8	10	200/4000
20300	3.0	10	200/4000
20320	3.2	10	200/4000
20350	3.5	10	100/4000
20400	4.0	10	100/4000
20420	4.2	10	100/2500
20450	4.5	10	100/2500
20500	5.0	10	100/2500
20550	5.5	10	100/2000
20600	6.0	10	50/1200
20650	6.5	10	50/1200
20700	7.0	10	50/1200
20800	8.0	5	50/600
20850	8.5	5	50/600
20900	9.0	5	50/600
21000	10.0	5	50/250
21100	11.0	5	50/250
21200	12.0	5	50/250
21250	12.5	5	50/250
21300	13.0	5	50/250
21400	14.0	5	50/200
21600	16.0	5	10/100

PL Komplet wiertel do metalu
 GB Twist drill set
 D Spiralbohrersatz
 RUS Набор сверл по металлу
 CZ Vrtáky na kov
 RO Burghie pt. metal
 H Fűrészár fémhez
 E Broca para metalo



STHOR

No.	Ø (mm)	pcs	Icon
22330	1.0; 1.5; 2.0; 2.5; 3.0; 3.5; 4.0; 4.5; 5.0; 5.5; 6.0; 6.5; 7.0; 7.5; 8.0; 8.5; 9.0; 9.5; 10.0	19	30
22340	1.0; 1.5; 2.0; 2.5; 3.0; 3.5; 4.0; 4.5; 5.0; 5.5; 6.0; 6.5; 7.0; 7.5; 8.0; 8.5; 9.0; 9.5; 10.0; 10.5; 11.0; 11.5; 12.0; 12.5; 13.0	25	20

PL Komplet wiertel do metalu
 GB Twist drill set
 D Spiralbohrersatz
 RUS Набор сверл по металлу
 CZ Vrtáky na kov
 RO Burghie pt. metal
 H Fűrészár fémhez
 E Broca para metalo



STHOR

No.	Ø (mm)	pcs	Icon
22130	1.5; 2.0; 2.5; 3.0; 3.2; 3.5; 4.0; 4.5; 4.8; 5.0; 5.5; 6.0; 6.5	13	25/100
22180	2.0; 2.5; 3.0; 3.5; 4.0; 4.5; 5.0; 5.5; 6.0; 6.5; 7.0; 7.5; 8.0	13	25/50

PL Komplet wiertel do metalu
 GB Twist drill set
 D Spiralbohrersatz
 RUS Набор сверл по металлу
 CZ Vrtáky na kov
 RO Burghie pt. metal
 H Fűrészár fémhez
 E Broca para metalo



STHOR

No.	Ø (mm)	pcs	Icon
22190	1.0; 1.5; 2.0; 2.5; 3.0; 3.5; 4.0; 4.5; 5.0; 5.5; 6.0; 6.5; 7.0; 7.5; 8.0; 8.5; 9.0; 9.5; 10.0	19	30
22250	1.0; 1.5; 2.0; 2.5; 3.0; 3.5; 4.0; 4.5; 5.0; 5.5; 6.0; 6.5; 7.0; 7.5; 8.0; 8.5; 9.0; 9.5; 10.0; 10.5; 11.0; 11.5; 12.0; 12.5; 13.0	25	20

PL Komplet wiertel do metalu
 GB Twist drill set
 D Spiralbohrersatz
 RUS Набор сверл по металлу
 CZ Vrtáky na kov
 RO Burghie pt. metal
 H Fűrészár fémhez
 E Broca para metalo



STHOR

No.	Ø (mm)	pcs	Icon
22300	1.5; 2.0; 2.5; 3.0; 3.2; 3.5; 4.0; 4.5; 4.8; 5.0; 5.5; 6.0; 6.5	13	25/100
22310	2.0; 2.5; 3.0; 3.5; 4.0; 4.5; 5.0; 5.5; 6.0; 6.5; 7.0; 7.5; 8.0	13	25/50

8

- PL Wiertło do metalu HSS
 GB HSS twist drill bit
 D Spiralbohrer HSS
 RUS Свёрло по металлу HSS
- CZ Vrták na kov HSS
 RO Burghiu pt. metal HSS
 H Fúrószár fémhez HSS
 E Broca para metalo HSS



- PL Komplet wiertel do metalu
 GB Twist drill set
 D Spiralbohrersatz
 RUS Набор свёрл по металлу
 CZ Vrtáky na kov
 RO Burghie pt. metal
 H Fúrószár fémhez
 E Broca para metalo



STHOR

No.	Ø (mm)	pcs	Icon
21998	2.0; 2.5; 3.0; 3.5; 4.0; 4.5; 5.0; 5.5; 6.0; 6.5; 7.0; 7.5; 8.0	13	10/50

- PL Komplet wiertel do metalu
 GB Twist drill set
 D Spiralbohrersatz
 RUS Набор свёрл по металлу
 CZ Vrtáky na kov
 RO Burghie pt. metal
 H Fúrószár fémhez
 E Broca para metalo



STHOR

No.	Ø (mm)	pcs	Icon
21999	1.0; 1.5; 2.0; 2.5; 3.0; 3.5; 4.0; 4.5; 5.0; 5.5; 6.0; 6.5; 7.0; 7.5; 8.0; 8.5; 9.0; 9.5; 10.0	19	5/30

- PL Wiertło do betonu
 GB Masonry drill bit
 D Betonbohrer
 RUS Свёрло по бетону
- CZ Vrták na beton
 RO Burghiu pt. beton
 H Fúrószár betonhoz
 E Broca para hormigon



STHOR

No.	Ø (mm)	L (mm)	Icon
23311	4	75	200/1600
23312	5	85	200/1600
23313	6	100	200/1000
23324	6	400	100/300
23314	7	100	200/1000
23315	8	120	100/500
23325	8	400	50/200
23316	10	120	100/500
23326	10	400	50/100
23317	12	150	50/200
23327	12	400	50/100
23318	14	150	50/150
23328	14	400	50/100
23319	16	150	50/150
23329	16	400	50/100
23320	18	150	50/150
23321	20	150	25/100

STHOR

No.	Ø (mm)	pcs packing	Icon
21900	1.0	10	20/1000
21905	1.5	10	20/1000
21910	2.0	10	20/800
21915	2.5	10	20/800
21919	3.0	10	20/500
21921	3.2	10	20/400
21924	3.5	10	10/400
21927	4.0	10	10/400
21929	4.2	10	10/250
21932	4.5	10	10/250
21934	4.8	10	10/250
21936	5.0	10	10/250
21941	5.5	10	10/200
21944	6.0	10	10/120
21948	6.5	10	5/120
21950	7.0	5	10/120
21951	7.5	5	10/120
21952	8.0	5	10/120
21955	8.5	5	10/120
21956	9.0	5	10/120
21958	10.0	5	10/50
21961	11.0	5	10/50
21963	12.0	5	10/50
21966	13.0	3	16/48

- PL Komplet wiertel do metalu
 GB Twist drill set
 D Spiralbohrersatz
 RUS Набор свёрл по металлу
 CZ Vrtáky na kov
 RO Burghie pt. metal
 H Fúrószár fémhez
 E Broca para metalo



STHOR

No.	Ø (mm)	pcs	Icon
21650	4, 5, 6, 8, 10	5	30/60

PL Wiertła do betonu
GB Masonry drill set
D Betonbohrer
RUS Набор сверл по бетону
CZ Souprava vrtáků do betonu
RO Set de burghie pt. beton
H Fúrózárkészlet betonhoz
E Brocas para hormigon



5
PCS



STHOR

No.	mm	pcs	Box
23331	4; 5; 6; 8; 10	5	50/200

PL Wiertła do drewna
GB Wood drill set
D Holzbohrersatz
RUS Набор сверл по дереву

CZ Vrtáky na dřevo
RO Burghie pt. lemn
H Fúró fához
E Brocas para maderaz

8
PCS

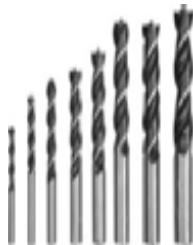

STHOR

No.	Ø (mm)	pcs	Box
22380	3; 4; 5; 6; 7; 8; 9; 10	8	20/100

PL Wiertła do drewna
GB Wood drill set
D Holzbohrersatz
RUS Набор сверл по дереву

CZ Vrtáky na dřevo
RO Burghie pt. lemn
H Fúró fához
E Brocas para maderaz

6
PCS



STHOR

No.	Ø (mm)	L (mm)	pcs	Box
22460	6; 8; 10; 12; 13; 14	300	6	25

PL Wiertła do drewna
GB Wood drill set
D Holzbohrersatz
RUS Набор сверл по дереву

CZ Vrtáky na dřevo
RO Burghie pt. lemn
H Fúró fához
E Brocas para maderaz

6
PCS

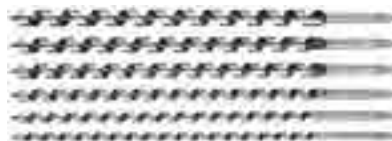

STHOR

No.	Ø (mm)	L (mm)	pcs	Box
22466	10; 12; 14; 16; 18; 20	460	6	10

PL Wiertła do drewna
GB Wood drill set
D Holzbohrersatz
RUS Набор сверл по дереву

CZ Vrtáky na dřevo
RO Burghie pt. lemn
H Fúró fához
E Brocas para maderaz

5
PCS



No.	Ø (mm)	pcs	Box
22350	4; 5; 6; 8; 10	5	25/200

PL Wiertła do drewna
GB Wood drill set
D Holzbohrersatz
RUS Набор сверл по дереву

CZ Vrtáky na dřevo
RO Burghie pt. lemn
H Fúró fához
E Brocas para maderaz

8
PCS



STHOR

No.	Ø (mm)	pcs	Box
22381	3; 4; 5; 6; 7; 8; 9; 10	8	10/80

PL Wiertła do drewna
GB Wood drill set
D Holzbohrersatz
RUS Набор сверл по дереву

CZ Vrtáky na dřevo
RO Burghie pt. lemn
H Fúró fához
E Brocas para maderaz

6
PCS

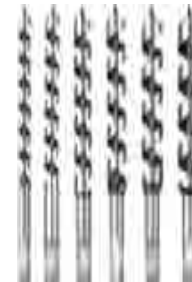

STHOR

No.	Ø (mm)	L (mm)	pcs	Box
22465	10; 12; 14; 16; 18; 20	230	6	10

PL Wiertła do drewna, łopatkowe
GB Flat wood bits
D Holz-Flachfräsbohrersatz
RUS Набор сверл по дереву

CZ Vrtáky na dřevo
RO Burghie pt. lemn
H Fúró fához
E Brocas para maderaz

6
PCS



No.	Ø (mm)	pcs	Box
22500	10; 12; 16; 18; 20; 25	6	10/100

PL Wiertło do betonu CZ Vrták na beton
 GB Masonry drill bit RO Burghiu pt. beton
 D Betonbohrer H Fúrószár betonhoz
 RUS Бур по бетону E Broca para hormigon



STHOR

No.	Ø (mm)	L (mm)	
23620	5	110	10/500
23640	6	110	10/500
23650	6	160	10/500
23660	6	210	10/300
23670	8	110	10/500
23680	8	160	10/400
23690	8	210	10/250
23692	8	300	10/200
23693	8	460	10/100
23694	8	600	10/100
23710	10	160	10/300
23720	10	210	10/250
23722	10	300	10/150
23723	10	460	10/100
23724	10	600	10/100
23730	12	160	10/300
23740	12	460	10/100
23750	12	266	10/150
23752	12	600	10/60
23800	14	166	10/200
23820	14	460	10/80
23830	14	266	10/150
23832	14	600	10/50
23840	16	200	10/160
23850	16	300	8/96
23860	16	460	8/48
23862	16	600	8/48
23880	18	300	8/72
23882	18	460	6/48
23883	18	600	6/48
23920	20	300	5/50
23930	20	460	5/50
23932	20	600	5/30
23960	22	460	5/25
23962	22	600	5/25
23980	25	300	5/50
23982	25	600	5/15
23990	25	460	5/25
23992	28	600	2/10
23999	30	600	2/10

PL Komplet wiertel do betonu
 GB Masonry drill set
 D Betonbohrersatz
 RUS Наб. буров по бетону
 CZ Souprava vrtáků do betonu
 RO Set de burghie pt. beton
 H Fúrószárkészlet betonhoz
 E Juego de brocas



STHOR

No.	Ø mm	pcs	
23988	5; 6; 8; 10; 12x160	5	15/60

PL Wiertło do betonu CZ Vrták na beton
 GB Masonry drill bit RO Burghiu pt. beton
 D Betonbohrer H Fúrószár betonhoz
 RUS Бур по бетону E Broca para hormigon



STHOR

No.	Ø (mm)	L (mm)	
23371	16	300	10/50
23390	16	600	5/30
23411	16	900	4/20
23372	18	300	10/50
23391	18	600	5/30
23412	18	900	4/20
23373	20	300	8/40
23392	20	600	4/20
23413	20	900	2/10
23374	22	300	6/30
23393	22	600	4/20
23414	22	900	2/10
23375	24	300	6/30
23394	24	600	4/20
23415	24	900	2/10
23376	25	300	6/30
23395	25	600	4/20
23416	25	900	2/10
23377	26	300	6/30
23396	26	600	2/10
23417	26	900	2/10
23378	28	300	4/20
23397	28	600	2/10
23418	28	900	5
23379	30	300	4/20
23398	30	600	2/10
23419	30	900	5
23380	32	300	4/20
23399	32	600	2/10
23420	32	900	5
23381	35	300	4/20
23400	35	600	2/10
23421	35	900	5
23382	37	300	4/20
23401	37	600	2/10
23422	37	900	5
23383	38	300	4/20
23402	38	600	2/10
23423	38	900	5
23403	40	600	5
23424	40	900	5

PL Grot SDS Plus CZ Špičák
 GB Point chisel RO Dorn
 D Spitzmeißel H Hegyes véső
 RUS Зубило пиковое E Cincel punta



STHOR

No.	Ø (mm)	L (mm)	
23590	14	250	25/50

PL Grot SDS Max CZ Śpićak
GB Point chisel RO Dorn
D Spitzmeißel H Hegyes véső
RUS Зубило пиковое E Cincel punta



STHOR

No.	Ø (mm)	L (mm)	Box
23601	18	280	20/40
23602	18	400	15/30

PL Dłuto wąskie SDS Max CZ Sekáč
GB Flat chisel RO Dalta spatulată
D Flachmeißel H Lapos véső
RUS Зубило узкое E Cincel plano



STHOR

No.	Ø (mm)	L (mm)	Box
23603	25x18	280	20/40
23604	25x18	400	10/20

PL Dłuto szerokie SDS Max CZ Sekáč plochý
GB Spade chisel RO Dalta
D Spatmeißel H Széles véső
RUS Зубило плоское широкое E Cincel pala



STHOR

No.	Ø (mm)	L (mm)	Box
23605	40x18	280	20/40
23606	50x18	400	10/20

PL Bruzdownik SDS Max CZ Sekáč drážkovací
GB Groove chisel RO Dalta canal
D Nutenmeißel H Horonyvėső
RUS Зубило-штробер E Cincel acanalado



STHOR

No.	Ø (mm)	L (mm)	Box
23608	25x18	400	10/20

PL Dłuto wąskie SDS Plus CZ Sekáč
GB Flat chisel RO Dalta spatulată
D Flachmeißel H Lapos véső
RUS Зубило узкое E Cincel plano



STHOR

No.	Ø (mm)	L (mm)	Box
23591	20x14	250	25/50

PL Dłuto szerokie SDS Plus CZ Sekáč plochý
GB Spade chisel RO Dalta
D Spatmeißel H Széles véső
RUS Зубило плоское широкое E Cincel pala



STHOR

No.	Ø (mm)	L (mm)	Box
23592	40x14	250	25/50

PL Bruzdownik SDS Plus CZ Sekáč drážkovací
GB Groove chisel RO Dalta canal
D Nutenmeißel H Horonyvėső
RUS Зубило-штробер E Cincel acanalado



STHOR

No.	Ø (mm)	L (mm)	Box
23593	22x14	250	25/50

PL Komplet wiertel i przecinaków do betonu CZ Souprava vrtáků + sekáče
GB Hammer drill & chisel set RO Set de burghie + dalte tăietor
D Bohrer und Meißel Satz H Fúrószárkészlet + hidegvágó
RUS Набор буров и зубил E Juego de cincelos y brocas

12
PCS

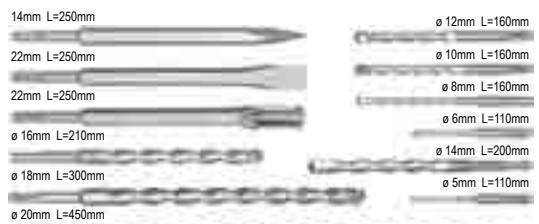

SDS
PLUS



VOREL

No.	pcs	Box
23585	12	8

- PL Komplet wiertel i przecinaków do betonu
- GB Hammer drill & chisel set
- D Bohrer und Meißel Satz
- RUS Набор буров и зубил
- CZ Souprava vrtáků + sekáče
- RO Set de burghie + dalte tăietor
- H Fúrószerkészlet + hidegvágó
- E Juego de cinceles y brocas

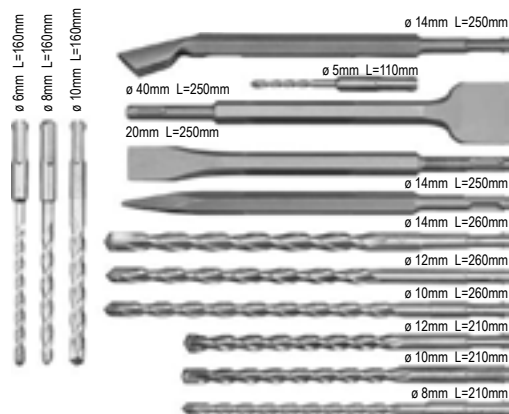

14
PCS

SDS PLUS



No.	pcs	
23586	14	6

- PL Wiertło koronowe do muru
- GB Hollow drill set
- D Bohrkronen
- RUS Коронка по бетону
- CZ Korunový vrták na zed' - pouzdro šestiúhelník
- RO Burghiu cu coroană pt. beton - mandrină hexagonală
- H Koronafúró falhoz - hatszögletű szárral
- E Broca widia para muro



No.	Ø (mm)	
03240	65	24
03241	80	20

- PL Wycinarka do płyt gipsowych
- GB Drywall circle cutter
- D Schnitzzirkel für Gipsplatten
- RUS Резак круговой по гипсокартону
- CZ Vystřihováčka pro sádrové desky
- RO Tăietoare pt. plăci de ghips
- H Gipszfalkivágó
- E Compas cortador para planchas de escayola



No.	Ø (mm)	
03990	30-400	12/48

- PL Wycinarka otworów do drewna
- GB Hole saw set
- D Lochsägensatz
- RUS Пилы кольцевые по дереву в наборе
- CZ Vytínač otvorů
- RO Tăietor (ferăstrău rotund) pt. orificii
- H Lyukasztó
- E Sierra de corona para mader



No.	Ø (mm)	pcs	
22572	38-127	9	6/24

- PL Wiertło koronowe do muru
- GB Hollow drill set
- D Bohrkronen
- RUS Коронка по бетону
- CZ Korunový vrták na zed' - pouzdro šestiúhelník
- RO Burghiu cu coroană pt. beton - mandrină hexagonală
- H Koronafúró falhoz - hatszögletű szárral
- E Broca widia para muro



No.	Ø (mm)	
03245	65	24
03246	80	20

- PL Wycinarka otworów do drewna
- GB Hole saw set
- D Lochsägensatz
- RUS Пилы кольцевые по дереву в наборе
- CZ Vytínač otvorů
- RO Tăietor (ferăstrău rotund) pt. orificii
- H Lyukasztó
- E Sierra de corona para madera



No.	Ø (mm)	pcs	
22565	51; 76; 89	4	12/48

- PL Zestaw wycinarek do otworów w drewnie
- GB Hole saw set
- D Lochsägensatz
- RUS Пилы кольцевые по дереву в наборе
- CZ Vytínač otvorů
- RO Tăietor (ferăstrău rotund) pt. orificii
- H Lyukasztó
- E Juego de sierras de corona

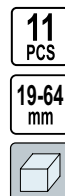

No.	Ø (mm)	pcs	
22570	19-64	11	12/36

- PL Zestaw wycinarek do otworów w drewnie
 GB Hole saw set
 D Lochsägensatz
 RUS Пилы кольцевые по дереву в наборе
- CZ Vytínač otvorů
 RO Tăietor (ferăstrău rotund) pt. orificii
 H Lyukasztó
 E Juego de sierras de corona



No.	Ø (mm)	pcs	Box
22571	64-127	8	6/24

- PL Wyrzynarka do drewna
 GB Hole saw for wood
 D Lochsägensatz
 RUS Пилы кольцевые по дереву
- CZ Vyřezávací pila
 RO Set freze decupat lemn
 H Szúrófűrész
 E Sierra de corona

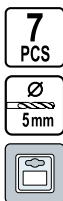

No.	Ø (mm)	L (mm)	Box
28710	26; 32; 38; 45; 50; 56; 63	17	10/100
28720	26; 32; 38; 45; 50; 56; 63	45	10/80

- PL Otwornica do PCV
 GB PVC Hole cutter
 D PVC Lochmesser
 RUS Сверло по дереву, гипсокартону, ПВХ
- CZ Otvornice na PVC
 RO Dispozitiv decupat PVC
 H Lyukasztó PVC
 E Cortador de agujeros de PVC

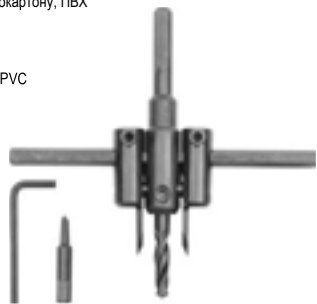

No.	Ø (mm)	pcs	Box
28733	30-120	3	6/60

- PL Wiertło do szkła i glazury
 GB Tile and glass drill
 D Glass- und Fliesbohrer
 RUS Сверло по плитке и стеклу
- CZ Vrták do skla a glazury
 RO Burghiu pt. sticlă și glazură
 H Üveg- és csempéfúró
 E Broca para cristal y azulejos



No.	L (mm)	Box
05540	4	50/100
05560	6	50/100
05580	8	50/100
05600	10	50/100

- PL Wyrzynarka do drewna, hartowane zęby
 GB Hole saw for wood with hardened teeth
 D Lochsägensatz
 RUS Пилы кольцевые по дереву закалённые зубья
- CZ Vyřezávací pila kalená
 RO Set freze circulare cu dinti caliti
 H Szúrófűrész edzett
 E Sierra de corona cortido

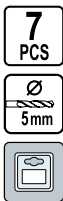

No.	Ø (mm)	L (mm)	Box
28680	26; 32; 38; 45; 50; 56; 63	17	10/100
28690	26; 32; 38; 45; 50; 56; 63	45	10/80

- PL Zestaw wycinarek do otworów
 GB Hole saw set
 D Lochsägensatz
 RUS Пилы кольцевые по дереву
- CZ Vytínač otvorů
 RO Set freze
 H Lyukasztó
 E Cortador de agujeros



No.	Ø (mm)	pcs	Box
28725	60; 67; 74; 81; 95	8	6/24

- PL Zestaw wycinarek wolframowych
 GB Tungsten carbide coated hole saw set
 D Lochbohrersatz
 RUS Коронки вольфрамовые
- CZ Sada děrovacích vrtáků pro keramiku
 RO Set freze + maner
 H Körkivógó készlet volfram borítással
 E Juego de punzones de volframo



No.	Ø (mm)	Box
03300	33; 53; 67; 73	20
03301	33; 53; 67; 83	20

- PL Gwintowniki
 GB Hand taps
 D Handgewindebohrer
 RUS Метчик
- CZ Závitníky
 RO Tarozi
 H Menetfűró
 E Machos de rosca



No.	M	pcs/packing	Box
24300	M3	3	25/100
24310	M4	3	25/100
24320	M5	3	25/100
24330	M6	3	25/100
24340	M7	3	25/100
24350	M8	3	25/100



PL Gwintowniki
GB Hand taps
D Handgewindebohrer
RUS Метчик

CZ Závítníky
RO Tarozii
H Menetűró
E Machos de rosca



No.	M	pcs packing	☐
24370	M10	3	25/100
24390	M12	3	25/100
24410	M14	3	20
24430	M16	3	20
24450	M18	3	20
24470	M20	3	20

PL Gwintownik maszynowy
GB Machine taps
D Maschinengewindebohrer
RUS Метчик машинный

CZ Strojní závítník
RO Tarod de maşină
H Gépi menetűró
E Macho mecanico



No.	Ø M	☐
24960	M3	25/100
24961	M4	25/100
24962	M5	25/100
24963	M6	25/100
24964	M8	25/100
24965	M10	25/100
24966	M12	25/100

PL Komplet gwintowników i narzynek
GB Tap and die set
D Gewindegewindebohrersatz
RUS Набор плашек и метчиков

CZ Souprava závítníků a kruhových závítočných čelistí
RO Set de tarozii și filiere
H Menetűró és menetűró készlet
E Juego de machos de rosca y cojinetes



No.	Ø M	pcs	☐
24900	M3; M4; M5; M6; M8; M10; M12	32	5

PL Komplet narzynek
GB Die set
D Aussengewindeschneidesatz
RUS Набор плашек

CZ Souprava kruhových závítočných čelistí
RO Set de filiere
H Menetűró készlet
E Juego de cojinetes



No.	Ø M	pcs	☐
24950	M3; M4; M5; M6; M7; M8; M10; M12	9	60

PL Narzynka
GB Circular die
D Schneideisen
RUS Плашка

CZ Kruhová závítočná čelist
RO Filieră
H Menetűró
E Cojnete de rosca



No.	Ø M	☐
24500	M3	25/100
24510	M4	25/100
24520	M5	25/100
24530	M6	25/100
24550	M8	25/100
24570	M10	25/100
24590	M12	25/100
24610	M14	25/100
24630	M16	15/60
24650	M18	30/60
24670	M20	15/60

PL Komplet gwintowników
GB Hand tap set
D Innengewindebohrersatz
RUS Набор метчиков

CZ Souprava závítníků
RO Set de tarozii
H Menetűró készlet
E Juego de machos de rosca



No.	Ø M	pcs	☐
24940	M3; M4; M5; M6; M7; M8; M10; M12	25	60

PL Grzechotka do gwintownika
GB Ratchet tap wrench
D Gewindebohrerratsche
RUS Вороток для метчиков с трещоткой

CZ Řečtačka na závítník
RO Cheie cu clichet pt. tarod
H Racsnis hajtűszár menetűróhoz
E Carraca para macho de rosca



No.	Ø M	☐
24700	M3-M8	25/100
24710	M5-M12	25/100

PL Pokrętło do gwintownika CZ Ovládací kolečko na závitník
 GB Tap wrench RO Cheie (măner) pt. tarod
 D Windeisen H Hajtőszár menetfúróhoz
 RUS Вороток для метчиков E Llave giramachos



No.	Ø M	
24730	M4-M8	30
24740	M9-M12	25
24750	M13-M18	20

PL Komplet gwintowników i narzynek CZ Souprava závitníků a kruhových závitových čelistí
 GB Tap and die set RO Set de tarozi și filiere
 D Gewindeschneidwerkzeugsatz H Menetfúró és menetvágó készlet
 RUS Набор плашек и метчиков E Juego de machos de roscar y cojinetes



No.	Ø M	
24295	M3x0.5; M4x0.7; M5x0.8; M6x1; M8x1.25; M10x1.5; M12x1.75	10/20

PL Komplet frezów do drewna CZ Souprava frézů do dřeva
 GB Router bit set RO Set de freze pt. lemn
 D Oberfräsesatz H Marókéskészlet fához
 RUS Набор сверл Форстнера по дереву E Juego de frezas para madera



VOREL

No.	Ø (mm)	pcs	
22550	8	12	5/20

PL Tarcza diamentowa "segment" CZ Diamantový kotouč segmentový
 GB Diamond blade segmented RO Disc diamantat segmentat
 D Diamanttrennscheibe H Szegmens gyémántkorong
 RUS Диск алмазный сегментированный E Disco de diamante de segmentos

VOREL

No.	Ø (mm)	min-1	
08710	110	12000	20/200
08711	115	12000	20/200
08712	125	11000	20/160
08714	180	8000	15/60
08715	230	6500	10/40

PL Oprawka do narzynek CZ Závitová objímka
 GB Die holder RO Portfilieră
 D Schneideisenhalter H Menetvágó tartó
 RUS Плашкодержатель E Portacojinete



No.	mm	
24800	20x7	30
24810	25x9	25
24813	30x11	25
24820	38x14	30
24823	45x16	20

PL Wykrętki do zerwanych śrub CZ Vrtáky do přetržených šroubů
 GB Screw extractor set RO Set extractoare pt. prezoane / suruburi
 D Schraubensatz H Törtsavar kihajtó
 RUS Экстракторы обломанных болтов E Destornillador para tornillos arrancados



No.	size / rozmiar	pcs	
24000	1/8" (3.2 mm) - 1/4" (6.3 mm) 1/4" (6.3 mm) - 5/16" (7.9 mm) 5/16" (7.9 mm) - 7/16" (11.1 mm) 7/16" (11.1 mm) - 9/16" (14.3 mm) 9/16" (14.3 mm) - 3/4" (19.0 mm)	5	12/120

PL Komplet frezów do drewna CZ Souprava frézů do dřeva
 GB Router bit set RO Set de freze pt. lemn
 D Oberfräsesatz H Marókéskészlet fához
 RUS Набор сверл Форстнера по дереву E Juego de frezas para madera



VOREL

No.	L (mm)	Ø (mm)	pcs	
22551	15; 20; 25; 30; 35	8	5	5/20



PL Tarcza diamentowa "segment"
 GB Diamond blade segmented
 D Diamantrennscheibe
 RUS Диск алмазный сегментированный

CZ Diamantový kotouč segmentový
 RO Disc diamantat segmentat
 H Szegmens gyémántkorong
 E Disco de diamante de segmentos



STHOR

No.	Ø (mm)	min-1	
08780	115x7.0x1.9x22.2	13200	20/120
08781	125x7.0x2.0x22.2	12000	20/120
08782	180x7.0x2.3x22.2	8400	15/45
08783	230x7.0x2.4x22.2	6600	10/30

PL Tarcza diamentowa pełna
 GB Diamond blade continuous rim
 D Diamantrennscheibe
 RUS Диск алмазный сплошной

CZ Diamantový kotouč /plný/
 RO Disc diamantat margine continua
 H Gyémántkorong /teljes/
 E Disco de diamante /entero/



STHOR

No.	Ø (mm)	min-1	
08785	115x5.0x1.9x22.2	13200	20/120
08786	125x5.0x2.0x22.2	12000	20/120
08787	180x5.0x2.3x22.2	8400	15/45
08788	230x5.0x2.4x22.2	6600	10/30

PL Tarcza diamentowa „Turbo”
 GB Diamond blade „Turbo”
 D Diamantrennscheibe „Turbo”
 RUS Отрезной алмазный диск „TURBO”

CZ Diamantový kotouč /Turbo/
 RO Disc diamantat Turbo
 H Gyémántkorong /Turbo/
 E Disco de diamante /Turbo/



STHOR

No.	Ø (mm)	min-1	
08790	115x7.0x2.0x22.2	13200	20/120
08791	125x7.0x2.1x22.2	12000	20/120
08792	180x7.5x2.4x22.2	8400	15/45
08793	230x7.5x2.6x22.2	6600	10/30

PL Tarcza diamentowa pełna
 GB Diamond blade continuous rim
 D Diamantrennscheibe
 RUS Диск алмазный сплошной

CZ Diamantový kotouč /plný/
 RO Disc diamantat margine continua
 H Gyémántkorong /teljes/
 E Disco de diamante /entero/



VOREL

No.	Ø (mm)	min-1	
08731	115	12000	20/200
08732	125	11000	20/160
08734	180	8000	15/60
08735	230	6500	10/40

PL Tarcza diamentowa „Turbo”
 GB Diamond blade „Turbo”
 D Diamantrennscheibe „Turbo”
 RUS Отрезной алмазный диск „TURBO”

CZ Diamantový kotouč /Turbo/
 RO Disc diamantat Turbo
 H Gyémántkorong /Turbo/
 E Disco de diamante /Turbo/



VOREL

No.	Ø (mm)	min-1	
08751	115	12000	20/200
08752	125	11000	20/160
08754	180	8000	15/60
08755	230	6500	10/40

PL Brzeszczot diamentowy
 GB Diamond rod saw
 D Diamantsägekordel
 RUS Полотно алмазное

CZ Lanko pilove diamentowe
 RO Panze diamentate
 H Fűrészlap-pálca, gyémántbevonatú
 E Hoja de sierra de diamante



VOREL

No.	L (mm)	
27575	300	20/100

- PL Pila tarczowa do drewna z węglikiem wolframu
 GB TCT circular saw blade for wood
 D Kreissägeblatt HM-Bestückt
 RUS Диск пильный с карбидом вольфрам
 CZ Kotoučová pila na dřevo z karbidem wolframu
 RO Ferăstrău circular cu dinți din wolfram pt. lemn
 H Wolframkarbidos körfűrészlap
 E Disco de sierra con carbono de tungsteno

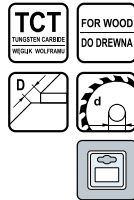

STHOR

No.	Ø (mm)	Ø d (mm)	R.P.M. max.	D (mm)	metal disc thickness / grubość tarczy (mm)	number of teeth / ilość zębów (T)	
08811	140	20	9600	2.0	1.3	16	25/50
08819	160	20	8300	2.0	1.4	18	25/50
08820	160	30	8300	2.0	1.4	24	25/50
08821	160	30	8300	2.0	1.4	36	25/50
08822	160	20	8300	2.0	1.4	48	25/50
08825	184	30	7400	2.2	1.4	24	10/20
08827	184	30	7400	2.2	1.4	40	10/20
08828	185	20	7400	2.2	1.4	18	10/20
08829	200	30	6500	2.2	1.6	24	10/20
08831	210	30	6500	2.2	1.6	40	10/20
08832	210	30	6500	2.2	1.6	60	10/20
08833	250	30	5400	3.0	1.8	24	10/20
08834	250	30	5400	3.0	1.8	40	10/20
08835	250	30	5400	3.0	1.8	60	10/20
08836	300	30	4500	3.2	2.0	24	10
08837	300	30	4500	3.2	2.0	40	10
08838	300	30	4500	3.2	2.0	60	10
08845	350	30	3800	3.2	2.2	40	10
08851	400	30	3300	3.2	2.2	60	10

- PL Tarcza do cięcia metalu
 GB Metal cutting disc
 D Trennscheibe für Metall
 RUS Диск отрезной по металлу
- CZ Souprava kotoučů pro řezání kovu
 RO Set de pânze de tăiat metal
 H Vágókorong készlet fémhez
 E Disco cortador para metal plano



STHOR

No.	Ø (mm)	min-1	
08170	115x1.0x22	13200	25/200
08174	115x3.0x22	13200	25/200
08171	125x1.0x22	12200	25/200
08175	125x3.0x22	12200	25/200
08177	230x3.0x22	6500	25/50

- PL Pila tarczowa do aluminium z węglikiem wolframu
 GB TCT circular saw blade for aluminium
 D Hartmetallbestückt Kreissägeblatt für Aluminium
 RUS Диск пильный по алюминию
 CZ Kotoučová pila na hliník s karbidem wolframu
 RO Disc circular pt. aluminiu
 H Wolframkarbidos körfűrészlap, alumíniumhoz
 E Disco de sierra con carbono

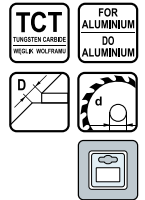

STHOR

No.	Ø (mm)	Ø d (mm)	R.P.M. max.	D (mm)	metal disc thickness / grubość tarczy (mm)	number of teeth / ilość zębów (T)	
08853	210	30	6500	2.2	1.6	72	10/20
08854	250	30	5400	3.0	1.8	100	10/20
08855	300	30	4500	3.2	2.0	100	10

- PL Tarcza do cięcia metalu
 GB Metal cutting disc
 D Trennscheibe für metall
 RUS Диск отрезной по металлу
- CZ Souprava kotoučů pro řezání kovu
 RO Set de pânze de tăiat metal
 H Vágókorong készlet fémhez
 E Disco cortador para metal plano



VOREL

No.	Ø (mm)	min-1	
08630	115x1.0x22	12000	25/200
08633	115x2.5x22	13300	25/200
08631	125x1.0x22	11000	25/200
08635	125x2.5x22	12200	25/200
08636	125x3.2x22	12200	25/200
08638	180x2.5x22	8500	25/100
08639	230x1.6x22	6600	25/50
08640	230x3.2x22	6600	25/50
08641	230x2.5x22	6600	25/50
08642	300x3.2x32	5100	10/20
08644	350x3.5x32	4400	10/20
08646	400x4.0x32	3800	10/20

- PL Tarcza do cięcia metalu wypukła
 GB Metal cutting disc – depressed centre
 D Metall-Trennscheibe gewölbt
 RUS Диск отрезной по металлу выпуклый
- CZ Souprava kotoučů pro řezání kovu
 RO Set de pânze de tăiat metal
 H Vágókorong készlet fémhez
 E Disco cortador para metalo concavo



VOREL

No.	Ø (mm)	min-1	
08656	125x3.2x22	12200	25/200
08658	230x3.2x22	6600	25/50

PL Tarcza do szlifowania metalu wypukła
 GB Metal grinding disc - depressed centre
 D Metall-Schleifscheibe gewölbt
 RUS Диск шлифовальный по металлу

CZ Kotouč pro broušení kovu
 RO Disc pt. șlefuit metal
 H Vágókorong fémhez
 E Disco de pulir de metalo



VOREL

No.	Ø (mm)	min-1	
08663	115x6.0x22	13300	25/100
08665	125x6.8x22	11000	25/100
08669	230x6.8x22	6600	25/50

PL Tarcza do szlifowania metalu wypukła
 GB Metal grinding disc - depressed centre
 D Metall-Schleifscheibe gewölbt
 RUS Диск шлифовальный по металлу выпуклый

CZ Kotouč pro broušení kovu
 RO Disc pt. șlefuit metal
 H Vágókorong fémhez
 E Disco de pulir de metalo



STMOR

No.	Ø (mm)	min-1	
08190	115x6.0x22	13200	25/100
08191	125x6.0x22	12200	25/100
08193	230x6.0x22	6500	10/20

PL Tarcza do cięcia kamienia wypukła
 GB Stone cutting disc - depressed centre
 D Stein-Trennscheibe gewölbt
 RUS Диск отрезной по камню

CZ Kotouč pro řezání kamene
 RO Disc pt. tăiat piatră
 H Vágókorong kőhöz
 E Disco cortador de piedra



STMOR

No.	Ø (mm)	min-1	
08200	115x3.0x22	13200	25/200
08201	125x3.0x22	12200	25/200
08203	230x3.0x22	6500	25/50

PL Tarcza do cięcia metalu wypukła
 GB Metal cutting disc - depressed centre
 D Metall-Trennscheibe gewölbt
 RUS Диск отрезной по металлу выпуклый

CZ Souprava kotoučů pro řezání kovu
 RO Set de pânze de tăiat metal
 H Vágókorong készlet fémhez
 E Disco cortador para metalo concavo



STMOR

No.	Ø (mm)	min-1	
08186	125x3.0x22	12200	25/200
08188	230x3.0x22	6500	25/50

PL Tarcza do cięcia kamienia
 GB Stone cutting disc
 D Stein-Trennscheibe
 RUS Диск отрезной по камню

CZ Kotouč pro řezání kamene
 RO Disc pt. tăiat piatră
 H Vágókorong kőhöz
 E Disco cortador de piedra



VOREL

No.	Ø (mm)	min-1	
08671	115x3.2x22	13200	25/200
08672	125x3.2x22	12200	25/200
08674	230x3.2x22	6600	25/50

PL Tarcza do szlifowania kamienia wypukła
 GB Stone grinding disc - depressed centre
 D Stein-Schleifscheibe gewölbt
 RUS Диск шлифовальный по камню

CZ Kotouč pro broušení kamene
 RO Disc pt. șlefuit piatră
 H Csiszolókorong kőhöz
 E Disco de pulir de piedra



VOREL

No.	Ø (mm)	min-1	
08681	115x6.0x22	13300	25/100
08683	125x6.8x22	11000	25/100

PL Ściernica listkowa talerzowa
GB Abrasive disc
D Lameller
RUS Диск лепестковый

CZ Kotouč brusný lamelový
RO Disc abraziv
H Lamellás csiszoló
E Disco abrasivo



VOREL

No.	type	Ø (mm)	min-1	
07974	P40	115	13300	50/200
07975	P60	115	13300	50/200
07976	P80	115	13300	50/200
07977	P100	115	13300	50/200
07978	P120	115	13300	50/200
07984	P40	125	12300	50/200
07985	P60	125	12300	50/200
07986	P80	125	12300	50/200
07987	P100	125	12300	50/200
07988	P120	125	12300	50/200

PL Tarcza do szlifierki stolowej
GB Grinding disc
D Schleifscheibe
RUS Круг для настольного
точильного станка

CZ Brusný kotouč
RO Discul abraziv
H Kőszűrűkő
E Disco abrasivo



VOREL

No.	Ø (mm)	min-1	
08860	125x12.7x17	5850	coarse-grained / gruboziamisty 10
08861	125x12.7x17	5850	fine-grained / drobnoziamisty 10
08864	150x12.7x16	5350	coarse-grained / gruboziamisty 10
08865	150x12.7x17	5350	fine-grained / drobnoziamisty 10
08868	150x31.75x25	5350	coarse-grained / gruboziamisty 10
08869	150x31.75x25	5350	fine-grained / drobnoziamisty 10
08873	200x15.88x20	3850	fine-grained / drobnoziamisty 10
08875	200x31.75x30	3850	fine-grained / drobnoziamisty 10

PL Tarcza łańcuchowa
GB Chain disc
D Kettentrennscheibe
RUS Круг отрезной цепной

CZ Řetězové kolo
RO Disc circular pt. lemn
H Lánctárcsa
E Disco de cadena



VOREL

No.	Ø (mm)	min-1	
08770	115	12000	10
08771	125	11000	10
08773	230	6800	10

PL Tarcza do szlifierki stolowej
GB Grinding disc
D Schleifscheibe
RUS Круг для настольного
точильного станка

CZ Brusný kotouč
RO Discul abraziv
H Kőszűrűkő
E Disco abrasivo



VOREL

No.	Ø (mm)	min-1	
08876	200x20x40	3850	5

PL Nożyce do blachy
GB Figure tin snips
D Blechscherer
RUS Ножницы по металлу

CZ Nůžky na plech
RO Foarfecă pt. tablă
H Lemezvágó olló
E Tijeras para hojalata



VOREL

No.	L (mm)	max (mm)	
48000	250	1.5	6/36

8

PL Nożyce do blachy
GB Figure tin snips
D Blechscher
RUS Ножницы по металлу

CZ Nůžky na plech
RO Foarfece pt. tablă
H Lemezvágó olló
E Tijeras para hojalata



VOREL

No.	L (mm)	max (mm)	
48060	250	1.2	6/48

PL Nożyce do blachy
GB Figure tin snips
D Blechscher
RUS Ножницы по металлу

CZ Nůžky na plech
RO Foarfece pt. tablă
H Lemezvágó olló
E Tijeras para hojalata



No.	L (mm)	
48100	250	6/60

PL Nożyce do blachy
GB Figure tin snips
D Blechscher
RUS Ножницы по металлу

CZ Nůžky na plech
RO Foarfece pt. tablă
H Lemezvágó olló
E Tijeras para hojalata



No.	L (mm)	
48200	250	6/60

PL Nożyce do blachy
GB Figure tin snips
D Blechscher
RUS Ножницы по металлу

CZ Nůžky na plech
RO Foarfece pt. tablă
H Lemezvágó olló
E Tijeras para hojalata



VOREL

No.	L (mm)	max (mm)	
48070	250	1.2	6/48

PL Nożyce do blachy
GB Figure tin snips
D Blechscher
RUS Ножницы по металлу

CZ Nůžky na plech
RO Foarfece pt. tablă
H Lemezvágó olló
E Tijeras para hojalata



VOREL

No.	L (mm)	max (mm)	
48080	250	1.0	6/36

PL Nożyce do blachy
GB Figure tin snips
D Blechscher
RUS Ножницы по металлу

CZ Nůžky na plech
RO Foarfece pt. tablă
H Lemezvágó olló
E Tijeras para hojalata



VOREL

No.	L (mm)	max (mm)	
48082	250	1.0	6/36

PL Nożyce do blachy
GB Figure tin snips
D Blechscher
RUS Ножницы по металлу

CZ Nůžky na plech
RO Foarfece pt. tablă
H Lemezvágó olló
E Tijeras para hojalata



VOREL

No.	L (mm)	max (mm)	
48050	250	1.5	6/36

PL Nożyce do blachy
GB Figure tin snips
D Blechscher
RUS Ножницы по металлу

CZ Nůžky na plech
RO Foarfece pt. tablă
H Lemezvágó olló
E Tijeras para hojalata



VOREL

No.	L (mm)	max (mm)	
48081	250	1.0	6/36

PL Nożyce do blachy
GB Figure tin snips
D Blechscher
RUS Ножницы по металлу

CZ Nůžky na plech
RO Foarfece pt. tablă
H Lemezvágó olló
E Tijeras para hojalata



No.	L (mm)	
48150	250	6/60

PL Nożyce do drutu
GB Bolt cutter
D Drahtschere
RUS Болторез

CZ Nůžky na drát
RO Cleste pt. buioane
H Drótvágó olló
E Tijeras para alambre

200 mm



No.	L (mm)	
49200	200	15/60

PL Nożyce do prętów
GB Bolt cutter
D Bolzenschneider
RUS Болторез

CZ Nůžky na tyče
RO Cleste pt. buioane
H Kábelvágó olló
E Tijeras para barras



No.	L (mm)	
49450	450	20
49600	600	10
49750	750	5

PL Pila do drewna
GB Hand saw for wood
D Handsäge
RUS Пила по дереву

CZ Pila na dřevo
RO Fierastrău „coada de vulpe” - pt. lemn
H Fafűrész, egyenes
E Sierra de mano



No.	L (mm)	
28380	400	10/40
28381	450	10/40
28382	500	10/40

PL Nożyce do blachy
GB Figure tin snips
D Blechscher
RUS Набор ножниц по металлу

CZ Nůžky na plech
RO Foarfece pt. tablă
H Lemezvágó olló
E Tijeras para hojalata

3 PCS

STRAIGHT PROSTE

RIGHT PRAWO

LEFT LEWE



No.	L (mm)	pcs	
48330	250	3	5/20

PL Glowica do nożyc do drutu
GB Bolt cutter head
D Schneiden für Bolzenschneider
RUS Головка для болтореза

CZ Hlava nůžek na tyče
RO Cap pt. cleste buioane
H Fej a kábelvágó ollóhoz
E Cabezal de tijeras para barras



No.	L (mm)	for / dla	
49460	450	49450	10/30
49760	750	49750	5/20

PL Nożyce do prętów profesjonalne
GB Bolt cutter
D Bolzenschneider
RUS Болторез „ПРОФИ”

CZ Nůžky na tyče
RO Cleste pt. buioane
H Kábelvágó olló
E Tijeras para barras



No.	L (mm)	Ø (mm)	
49770	350	6	24
49771	450	8	12
49772	600	10	12
49773	750	12	6
49774	900	14	4
49775	1050	16	2

- PL Pila platnica
- GB Hand saw for wood
- D Handsäge
- RUS Пила по дереву
- CZ Pila na dřevo
- RO Fierastrău „coada de vulpe” - pt. lemn
- H Fafűrész, egyenes
- E Sierra de mano

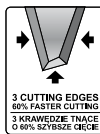

65 Mn
7T inch
1.6mm
0.9mm
HRC 50-54

PTFE COATED BLADE
POWLOKA PTFE



No.	L (mm)	
28385	400	12/48
28386	450	10/40
28387	500	10/40

- PL Pila kablakowa
- GB Bow saw
- D Bögelsäge
- RUS Лучковая пила по дереву
- CZ Oblouková pila
- RO Ferăstrău de curbură
- H Keretes fűrész
- E Sierra de arco



No.	L (mm)	
28740	515	24
28750	735	24

- PL Pila kablakowa
- GB Bow saw
- D Bögelsäge
- RUS Лучковая пила по дереву
- CZ Oblouková pila
- RO Ferăstrău de curbură
- H Keretes fűrész
- E Sierra de arco



No.	L (mm)	
28746	610	12/24
28755	760	12/24

- PL Pila otwornica
- GB Compass saw
- D Astsäge
- RUS Пила выкружная
- CZ Pila otwornica
- RO Ferăstrău coadă de șoarece
- H Lyukfűrész
- E Sierra compas

300 mm



No.	L (mm)	
28650	300	30/120

- PL Pila do drewna
- GB Hand saw for wood
- D Handsäge
- RUS Пила по дереву
- CZ Pila na dřevo
- RO Fierastrău „coada de vulpe” - pt. lemn
- H Fafűrész, egyenes
- E Sierra de mano



No.	L (mm)	
28394	400	12/60
28395	450	12/60

- PL Pila kablakowa
- GB Bow saw
- D Bögelsäge
- RUS Лучковая пила по дереву
- CZ Oblouková pila
- RO Ferăstrău de curbură
- H Keretes fűrész
- E Sierra de arco



No.	L (mm)	
28745	530	12/24

- PL Brzeszczot
- GB Spare blade for bow saw
- D Bögelsägeblatt
- RUS Полотно для лучковой пилы по сырому дереву
- CZ Ostří na dřevo
- RO Panza fierastrău tip arc
- H Fűrészlap fához
- E Hoja de sierra

WET WOOD

DREWNO MOKRE



No.	L (mm)	W (mm)	
28771	530	20	60/240
28772	610	20	60/240
28773	760	20	60/240

- PL Pila do gazobetonu
- GB Saw for gas concrete
- D Gasbetonsäge
- RUS Пила по газобетону с твердосплавным зубом
- CZ Pila na plynobeton
- RO Fierastrău cu placute vidia pt. BCA
- H Fűrész gázbetonhoz
- E Sierra para gas hormigon

600 mm



No.	L (mm)	teeth / zęby	
28000	600	33/33	5
28010	600	33/17	5

PL Pila do gazobetonu
 GB Saw for gas concrete
 D Gasbetonsäge
 RUS Пила по газобетону с твердосплавным зубом

CZ Pila na plynobeton
 RO Fierăstrău cu placute vidia pt. beton
 H Fűrész gázbetonhoz
 E Sierra para gas hormigon



VOREL

No.	L (mm)	teeth / zęby	
28011	600	15	6/12
28012	660	34	6/12

PL Pila do metalu
 GB Hacksaw frame
 D Metallsägebogen
 RUS Ножовка по металлу

CZ Pila na kov
 RO Ferăstrău pt. metal
 H Fémfűrész
 E Sierra de metalo

300 mm



No.	L (mm)	
27100	300	12/60

PL Pila do metalu
 GB Hacksaw frame
 D Metallsägebogen
 RUS Ножовка по металлу

CZ Pila na kov
 RO Ferăstrău pt. metal
 H Fémfűrész
 E Sierra de metalo

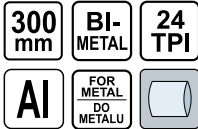

VOREL

No.	L (mm)	
27322	300	6/36

PL Pila do metalu
 GB Hacksaw frame
 D Metallsägebogen
 RUS Ножовка по металлу

CZ Pila na kov
 RO Ferăstrău pt. metal
 H Fémfűrész
 E Sierra de metalo

150 mm



No.	L (mm)	
27600	150	30/150

PL Pila do metalu
 GB Hacksaw frame
 D Metallsägebogen
 RUS Ножовка по металлу

CZ Pila na kov
 RO Ferăstrău pt. metal
 H Fémfűrész
 E Sierra de metalo

300 mm



No.	L (mm)	
27000	300	12/48

PL Pila do metalu
 GB Hacksaw frame
 D Metallsägebogen
 RUS Ножовка по металлу

CZ Pila na kov
 RO Ferăstrău pt. metal
 H Fémfűrész
 E Sierra de metalo

300 mm



No.	L (mm)	
27200	300	20/60

PL Pila do metalu
 GB Hacksaw frame
 D Metallsägebogen
 RUS Ножовка по металлу

CZ Pila na kov
 RO Ferăstrău pt. metal
 H Fémfűrész
 E Sierra de metalo

300 mm



JUCO

No.	L (mm)	
27495	300	5

PL Pila poprzeczna
 GB Cross - cut saw
 D Bauchsäge
 RUS Пила двуручная

CZ Pila břichatka
 RO Joagar
 H Keresztvágó fűrész
 E Sierra para corte cruzado

100 cm



No.	L (cm)	type	
28790	100	L-1000	10

PL Pila kątowa
GB Precision mitre saw
D Präzisions-Gehrungssäge
RUS Стусло металлическое „ПРОФИ”

CZ Úhlová pila
RO Fierastru pt. taiat la unghi
H Kézifűrész
E Sierra de angulo



VOREL

No.	mm	angle / kať	
29000	550	22.5°; 30°; 36°; 45°; 90°	1

PL Drewniana skrzynka uciosowa
GB Wooden mitre box
D Gehrungsschneidlade
RUS Стусло деревянное

CZ Ustřihací skříňka dřevená
RO Cutie din lemn pt. taiat oblic
H Vágósablon fa
E Gria de ingletar de madera



VOREL

No.	box / skrzynka (mm)	
29210	300x80	10
29220	450x105	12

PL Skrzynka uciosowa
GB Plastic mitre box
D Schneidlade
RUS Стусло пластмассовое

CZ Ustřihací skříňka z umělé hmoty
RO Cutie din plastic pt. taiat oblic
H Vágósablon műanyag
E Gria de ingletar de plastic



VOREL

No.	box / skrzynka (mm)	
29313	280x90	30

PL Skrzynka uciosowa
GB Plastic mitre box
D Schneidlade
RUS Стусло пластмассовое

CZ Ustřihací skříňka z umělé hmoty
RO Cutie din plastic pt. taiat oblic
H Vágósablon műanyag
E Gria de ingletar de plastic

VOREL

No.	box / skrzynka (mm)	
29323	325x125	18

PL Pila kątowa uchylna - 2 kąty cięcia
GB Precision mitre saw - 2 angles
D Präzisionsgehrungssäge kipbar
RUS Стусло металлическое наклонное „ПРОФИ”

CZ Úhlová pila sklápěcí
RO Fierastru de taiat la unghi in doua plane
H Kézifűrész, dönthető
E Sierra de angulo desviable
2 angulos de corte



VOREL

No.	mm	angle / kať	
29050	550	45°; 55°; 60°; 72°; 90°	1

PL Skrzynka uciosowa
GB Plastic mitre box
D Schneidlade
RUS Стусло пластмассовое

CZ Ustřihací skříňka z umělé hmoty
RO Cutie din plastic pt. taiat oblic
H Vágósablon műanyag
E Gria de ingletar de plastic



VOREL

No.	box / skrzynka (mm)	
29311	250x45	70
29312	285x60	50

PL Skrzynka uciosowa
GB Plastic mitre box
D Schneidlade
RUS Стусло пластмассовое

CZ Ustřihací skříňka z umělé hmoty
RO Cutie din plastic pt. taiat oblic
H Vágósablon műanyag
E Gria de ingletar de plastic



VOREL

No.	box / skrzynka (mm)	
29317	230x50	50
29318	250x65	50
29319	290x85	30

PL Skrzynka uciosowa
GB Plastic mitre box
D Schneidlade
RUS Стусло пластмассовое

CZ Ustřihací skříňka z umělé hmoty
RO Cutie din plastic pt. taiat oblic
H Vágósablon műanyag
E Gria de ingletar de plastic



PL Brzeczczoty
GB Hacksaw spare blades
D Metallsägeblatt
RUS Полотно двустороннее

CZ Čepele
RO Pânze
H Fémfűrészlap
E Hojas

300 mm



No.	type	L (mm)	W (mm)	pcs packing	box
27500	RAMB	300	25	72	10



No.	type	L (mm)	W (mm)	pcs packing	box
27501	RAMC	300	12	144	10



No.	type	L (mm)	W (mm)	pcs packing	box
27502	RAMA	300	12	144	10



No.	type	L (mm)	W (mm)	pcs packing	box
27505	RAME	300	20	72	10



No.	type	L (mm)	W (mm)	pcs packing	box
27506	RAMF	300	20	72	10



No.	type	L (mm)	W (mm)	pcs packing	box
27510	RAMD	300	25	72	10

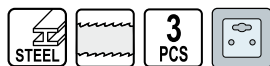

No.	type	L (mm)	W (mm)	pcs packing	box
27511	RAMB	300	25	3	50



No.	type	L (mm)	W (mm)	pcs packing	box
27513	RAMD	300	25	3	50

PL Brzeczczot do metalu
GB Spare blade for precision mitre saw for metal
D Metallsägeblatt
RUS Полотна для ножовки по металлу
CZ Pilový list na kovy
RO Panza fierastrau metale o fata taietoare
H Fémfűrész lap
E Hoja de sierra para metalo

12 PCS

300 mm



No.	L (mm)	pcs packing	box
27520	300	12	20/120

PL Brzeczczoty
GB Hacksaw spare blades
D Metallsägeblatt
RUS Полотно по металлу для МИНИ-НОЖОВКИ

CZ Čepele
RO Pânze
H Fémfűrészlap
E Hojas

10 PCS

150 mm



No.	L (mm)	pcs packing	box
27800	150	10	8/120

PL Brzeczczot do drewna i PCV
GB Spare blade for precision mitre saw for wood & PVC
D PVC und Holzsaägeblatt
RUS Полотно по дереву и ПВХ
CZ Pilový list na dřevo a PVC
RO Panza fierastrau pt. lemn si PVC
H Fűrészlap fához és PVC-hez
E Hoja de sierra para madera y PVC

550 mm



No.	L (mm)	W (mm)	mm	teeth / inch zęby / cal	box
29090	550	45	0.7	18	50

PL Brzeczczot do metalu
GB Spare blade for precision mitre saw for metal
D Metallsägeblatt
RUS Полотно по металлу
CZ Pilový list na kovy
RO Panza fierastrau pt. metal
H Fémfűrész lap
E Hoja de sierra para metalo

550 mm



No.	L (mm)	W (mm)	mm	teeth / inch zęby / cal	box
29100	550	45	0.7	32	50

PL Brzeszczoły do wyrzynarki elektrycznej
 GB Jig saw blades
 D Stichsägeblätter
 RUS Полотно для электролобзика

CZ Pilový list do přímočaré pily
 RO Panza fierastrau circular
 H Dekopírlap
 E Recambio sierra de calar



No.	mm	pcs packing	
27810	100/75	5	100/400



No.	mm	pcs packing	
27811	100/75	5	100/400



No.	mm	pcs packing	
27812	100/75	5	100/400



No.	mm	pcs packing	
27813	100/75	5	100/400



No.	mm	pcs packing	
27814	76/50	5	100/400



No.	mm	pcs packing	
27815	100/75	5	100/400



No.	mm	pcs packing	
27820	4x100/75: 1x76x50	5	100/400

PL Brzeszczoły do wyrzynarki elektrycznej
 GB Jig saw blades
 D Stichsägeblätter
 RUS Полотно для электролобзика

CZ Pilový list do přímočaré pily
 RO Panza fierastrau circular
 H Dekopírlap
 E Recambio sierra de calar



No.	mm	pcs packing	
27830	100/75	5	100/400



No.	mm	pcs packing	
27831	100/75	5	100/400



No.	mm	pcs packing	
27832	76/50	5	100/400



No.	mm	pcs packing	
27833	100/75	5	100/400



No.	pcs mm	pcs packing	
27834	4x100/75: 1x76/50	5	100/400

PL Szczotka druciana
GB Steel wire brush
D Stahldrahtbürste
RUS Щетка проволочная стальная

CZ Drátěný kartáč
RO Perie de sârmă
H Drótkefe
E Cepillo de acero



No.	rows / rzędy	
06930	3	12/120
06940	4	12/120
06950	5	12/120
06960	6	12/120

PL Szczotka druciana mosiężna
GB Brass wire brush
D Messingdrahtbürste
RUS Щетка проволочная латунная

CZ Drátěný kartáč mosazný
RO Perie de sârmă din alamă
H Réz drótkefe
E Cepillo de latón



No.	
06965	25/100

PL Szczotka tarczowa, drut karbowany
GB Circular brush - crimped wire
D Stahldraht - Kegelfbürste
RUS Щетка-крацевка с гайкой

CZ Kotoučový kartáč, rýhovaný drát
RO Perie rotundă, sârmă ondulată
H Tarcás drótkefe, sodrott dróttal
E Cepillo redondo de alambre ondulado



No.	Ø (mm)	min-1	
06972	100	12500	12/72
06973	115	12500	12/72

PL Komplet szczotek drucianych
GB Plastic handle wire brush set
D Stahlbürstensatz
RUS Набор 3-х мини-щёток

CZ Kartáče
RO Perie set
H 3 db-os kefékészlet
E Juego de 3 cepillos



No.	L (mm)	
06963	170	24/240
06964	220	24/72

PL Szczotka czolowa z gwintem, drut karbowany
GB Cup brush - crimped wire
D Stahldraht - Topfbürste
RUS Щетка-крацевка чашка с гайкой

CZ Čelní kartáč, rýhovaný drát
RO Perie frontală, sârmă ondulată
H Homlok drótkefe, sodrott dróttal
E Cepillo de copa de alambre ondulado



No.	Ø (mm)	min-1	
06970	75	12500	12/72
06971	100	8500	6/24

PL Szczotka czolowa z gwintem, drut splatany
GB Cup brush - twisted wire
D Stahldraht - Zopfopfbürste
RUS Щетка - крацевка круговая крученая
щетка крацевка (чашка)

CZ Čelní kartáč, pletený drát
RO Perie frontală, sârmă împletită
H Homlok drótkefe, sodrott dróttal
E Cepillo de copa de alambre conico



No.	Ø (mm)	min-1	
06974	65	12500	12/36
06975	80	8500	12/36
06976	100	8500	6/24

- PL Szczotka tarczowa z gwintem, drut splatany
 GB Circular brush - twisted wire
 D Stahldraht - Kegelmürste
 RUS Щетка-крацовка-усиленная
- CZ Kotouřový kartáč, pletený drát
 RO Perie rotativă, sârmă împletită
 H Tarcşás drótkefe, egyenes dróttal
 E Cepillo redondo de alambre conico

100
 Ømm



No.	Ø (mm)	min-1	Icon
06977	100	12500	12/48

- PL Szczotka tarczowa, drut splatany
 GB Circular brush - twisted wire
 D Stahldraht - Zopfscheibenbürste
 RUS Дисксовая щетка витая
- CZ Kotouřový kartáč
 RO Perie rotativă
 H Tarcşás drótkefe
 E Cepillo redondo de alambre conico



No.	Ø (mm)	min-1	Icon
06981	100	11000	12/72
06982	115	11000	12/48
06983	150	9000	12/36

- PL Szczotka czolowa z trzpieniem, drut karbowany
 GB Cup brush - crimped wire
 D Stahldraht - Topfbürste
 RUS Щетка-крацовка со стержнем чашка
 CZ Čelní kartáč, z hrotem, rýhovaný drát
 RO Perie frontală cu coadă, sârmă ondulată
 H Homlok drótkefe, nyéllal, sodrott dróttal
 E Cepillo de copa con mandril, de alambre ondulado



No.	Ø (mm)	min-1	Icon
06987	50	4500	10/180
06988	75	4500	12/96

- PL Szczotki druciane okragle
 GB Steel wire brush set
 D Stahldraht - Bürstensatz
 RUS Набор щеток
- CZ Drátěné kartáče kulaté
 RO Perii de sârmă rotunde
 H Kerek drótkefe
 E Cepillos de alambre redontos



No.	min-1	Icon
06990	4500	20/120

- PL Szczotka tarczowa, drut karbowany
 GB Circular brush - crimped wire
 D Stahldraht - Scheibenbürste
 RUS Щетка-крацовка латунированная сталь
- CZ Kotouřový kartáč
 RO Perie rotativă
 H Tarcşás drótkefe
 E Cepillo redondo de alambre ondulado



No.	Ø (mm)	min-1	Icon
06978	125	6000	12/72
06979	150	6000	12/36
06980	200	4500	12/24

- PL Szczotka tarczowa z trzpieniem, drut karbowany
 GB Circular brush - crimped wire
 D Stahldraht - Scheibenbürste mit Dorn
 RUS Щетка-крацовка со стержнем
 CZ Kotouřový kartáč, z hrotem, rýhovaný drát
 RO Perie rotundă cu coadă sârmă ondulată
 H Tarcşás drótkefe, nyéllal, sodrott dróttal
 E Cepillo redondo con mandril de alambre ondulado



No.	Ø (mm)	min-1	Icon
06985	75	4500	10/120
06986	100	4500	12/120

- PL Szczotki druciane z trzpieniem, drut karbowany
 GB Wire brush set
 D Stahldraht-Bürstensatz
 RUS Набор щеток-крацовок со стержнем
- CZ Okružní kartáč drátěný se stopkou
 RO Set perii sarma ondulata
 H Tarcşás drótkefe, nyéllal, sodrott dróttal
 E Cepillos de alambre con mandril

3
 PCS



No.	Ø (mm)	min-1	Icon
06989	25; 50; 50	4500	12/60

- PL Szczotka czolowa z trzpieniem, drut karbowany
 GB Cup brush - crimped wire
 D Stahldraht - Topfbürste
 RUS Щетка-крацовка „КИСТЬ” со стержнем
- CZ Čelní kartáč, z hrotem, rýhovaný drát
 RO Perie frontală cu coadă, sârmă ondulată
 H Homlok drótkefe, nyéllal, sodrott dróttal
 E Cepillo de copa con mandril, de alambre ondulado



No.	Ø (mm)	min-1	Icon
06992	24	4500	24/192

- PL Szczotka tarczowa z trzpieniem, drut splatany
 GB Circular brush - twisted wire
 D Stahldraht - Zopf scheibenbürste mit Dorn
 RUS Щетка-крацовка витая
 CZ Kotoučový kartáč, z hrotem, pletený drát
 RO Perie rotativă cu coadă sărmă împletită
 H Tarcás drótkefe, nyéllel, egyenes dróttal
 E Cepillo redondo con mandril de alambre conico



VOREL

No.	Ø (mm)	min-1	☐
06993	75	12500	30/180

- PL Rotoflex przegubowy
 GB Rotoflex profi
 D Rotoflex profi
 RUS Насадка резиновая с фиксатором угла наклона, с липучкой, для дрели
- CZ Kloubový rotoflex
 RO Suport disc abraziv, fixare scai
 H Csuklós rotoflex
 E Rotoflex articulado



125
Ømm



PRO

No.	Ø (mm)	min-1	☐
08300	125	2000	20

- PL Przystawka-dysk z trzpieniem
 GB Rubber disc with arbor
 D Klett - Haftteller + Ersatzdorn
 RUS Насадка резиновая с шестигранным хвостовиком, для дрели
- CZ Nástavec-kotouč s upínacím trnem
 RO Disc cu știft, ajutor
 H Csizsoló korong nyéllel
 E Disco de goma con mandril

125
Ømm



VOREL

No.	Ø (mm)	min-1	☐
08314	125	3250	30/120

- PL Przystawka do szlifierek kątownych i wiertarek
 GB Rubber disc for angle grinder and drill machine
 D Klett - Haftstützteller mit Gewindeflansch und Ersatzdorn
 RUS Насадка шлифовальная, гайка M14 с липучкой+ переход
 CZ Kotouč do úhelníků ze zipem
 RO Suport disc abraziv, fixare scai
 H Euro lemez élhez, tapadókoronggal
 E Disco de goma para ancul con mandril

M14 125
Ømm



VOREL

No.	Ø (mm)	min-1	☐
08316	125	12200	30/120

- PL Szczotka czolowa z trzpieniem, drut splatany
 GB Cup brush - twisted wire
 D Stahldraht - Zopf runderbürste
 RUS Щетка-крацовка витая со стержнем
 CZ Čelní kartáč, z hrotem, pletený drát
 RO Perie frontală cu coadă, sărmă împletită
 H Homlok drótkefe, nyéllel, egyenes dróttal
 E Cepillo de copa con mandril de alambre conico



VOREL

No.	Ø (mm)	min-1	☐
06994	75	12500	12/96
06995	22	4500	24/192

- PL Przystawka z rzepem
 GB Rubber disc with velcro
 D Klett - Haftstützteller mit Dorn
 RUS Насадка резиновая с шестигранным хвостовиком, для дрели
- CZ Přídavné zařízení ze zipem
 RO Disc-Suport cu scai pt. hárte abrazivă rotundă
 H Kistál tapadókoronggal
 E Disco de goma con velcro



125
Ømm



VOREL

No.	Ø (mm)	min-1	☐
08312	125	2000	12/120

- PL Euro dysk do kątowniki z rzepem
 GB Rubber disc for angle grinder with velcro
 D Klett - Haftteller + Gewindeflansch
 RUS Насадка пластиковая жесткая под круг на липучке
- CZ Euro disk do úhelníků ze zipem
 RO Suport disc abraziv, fixare scai
 H Euro lemez élhez, tapadókoronggal
 E Disco de goma para angul con velcro

M14



VOREL

No.	Ø (mm)	min-1	☐
08315	125	12200	30/120

- PL Tarcza do kątowniki z rzepem
 GB Rubber disc for angle grinder with velcro
 D Klett - Gummihafstützteller mit Gewindeflansch
 RUS Насадка шлифовальная под круг на липучке
 CZ Kotouč do úhelníků ze zipem
 RO Suport disc abraziv, fixare scai
 H Euro lemez élhez, tapadókoronggal
 E Disco para el pulidor angular con sujetador Velcro

M14 125
Ømm



VOREL

No.	Ø (mm)	min-1	☐
08318	125	12500	25/100

- PL Tarcza gumowa „multi-dysk” z rzepem
 GB „MULTI-DYSK” rubber disc with velcro
 D Gummihaftstützteller
 RUS Насадка резиновая поворотная с липучкой, для дрели
- CZ Terč multi-dysk ze zipem
 RO Suport disc abraziv, fixare scai
 H Multidisc tárcsa tapadókorong
 E Multi-disco con velcro



PRO
FILL

No.	Ø (mm)	min-1	☐
08350	125	2000	20

- PL Euro dysk do kątowniki z rzepem
 GB Rubber disc for angle grinder with velcro
 D Klett - Haftstützteller mit Gewindeflansch
 RUS Насадка пластиковая жесткая под круг на липучке
- CZ Euro disk do úhelníků ze zipem
 RO Euro disc cu scai pt. polizor unghiular
 H Euro lemez élhez, tapadókoronggal
 E Disco de goma para angul con velcro



PRO
FILL

No.	Ø (mm)	min-1	☐
08500	125	10000	20
08510	150	8500	20

- PL Euro dysk do kątowniki z trzpieniem
 GB Rubber disc for angle grinder
 D Klett - Haftstützteller mit Gewindeflansch und Ersatzdorn
 RUS Насадка шлифовальная, гайка M14 с липучкой + переход
- CZ Euro disk do úhelníků
 RO Euro disc cu scai pt. polizor unghiular
 H Euro lemez élhez, tapadókoronggal
 E Disco de goma para ancil con mandril



PRO
FILL

No.	Ø (mm)	min-1	☐
08501	125	10000	20

- PL Rzep do tarczy gumowej /przylepiec/
 GB Polishing felt disc
 D Klettdisk für Gummistützteller
 RUS Круг с липучкой
- CZ Zip do pryžového kotouče /suchý zip/
 RO Disc pasla de lustruit cu scai
 H Tapadókorong gumitárcsához
 E Velcro para disco de goma



VOREL

No.	Ø (mm)	☐
08520	150	10/100
08521	125	10/100

- PL Przystawka z rzepem
 GB Rubber disc with velcro
 D Klett - Haftstützteller mit Dorn
 RUS Насадка резиновая с хвостовиком и липучкой для дрели
- CZ Přídavné zařízení ze zipem
 RO Suport disc abraziv, fixare scai
 H Kistál tapadókoronggal
 E Disco de goma con velcro



PRO
FILL

No.	Ø (mm)	min-1	☐
08400	125	2000	20
08410	150	2000	20

- PL Przystawka-dysk na śrubę
 GB Rubber disc (screw)
 D Fiberscheiben - Stützteller mit Dorn
 RUS Насадка резиновая для дрели с липучкой и хвостиком
- CZ Přídavné zařízení –disk pro šroubu
 RO Suport disc abraziv, fixare scai
 H Tál-lemez csavarozott
 E Disco de goma /tornillo/



PRO
FILL

No.	Ø (mm)	min-1	☐
08450	125	2000	20

- PL Tarcza do kątowniki z rzepem nr 2
 GB Rubber disc for angle grinder with velcro
 D Klett - Gummihaftstützteller mit Gewindeflansch
 RUS Насадка шлифовальная под круг на липучке
- CZ Kotouč do úhelníků ze zipem číslo 2
 RO Disc de păsă cu scai nr. 2 pt. polizor unghiular
 H Euro lemez élhez, tapadókoronggal, 2 sz.
 E Disco de goma para angul con velcro



PRO
FILL

No.	Ø (mm)	min-1	☐
08511	125	10000	20

- PL Filc polerski na rzep
 GB Polishing felt disc
 D Filzpolierdisc
 RUS Полировальная насадка из фетра на липучке
- CZ Leštičí plstěnc na zip
 RO Disc pasla de lustruit cu scai
 H Polirozó filc tapadókoronggal
 E Fieltro de pulir con velcro



PRO
FILL

No.	Ø (mm)	min-1	☐
08522	125	10000	100

PL Nóż składany CZ Kapesni nůž
 GB Folding utility knife RO Briceag
 D Klappmesser H Zsebkés
 RUS Нож складной E Navaja



VOREL

No.	mm	
76526	61x33x0.5	12/72

PL Nóż składany sierpak CZ Montážní nůž
 GB Electrician's knife RO Cutit pt. decablat
 D Montagmesser H Szerelőkés
 RUS Нож складной E Cuchillo de montaje



VOREL

No.	blade / ostrze (mm)	
76622	85	10/100

PL Nóż monterski CZ Montážní nůž
 GB Cable knife RO Cutit pt. decablat
 D Montagmesser H Szerelőkés
 RUS Нож электрика E Cuchillo de montaje



No.	type	
76650	K-508	50

PL Nóż uniwersalny CZ Univerzální nůž
 GB Utility knife RO Cutter metallic
 D Universalmesser H Univerzálnis kés
 RUS Нож универсальный, лезвие трапеция, металлический корпус E Cutter universal



No.	blade / ostrze (mm)	
76000	61x19	25/200

PL Nóż składany sierpak CZ Dřevěný nůž srpek
 GB Lock knife RO Cutit secera maner lemn
 D Klappmesser H Hajított pengéjű kés, fanyelű
 RUS Нож складной E Cuchillo falciforme de madera



VOREL

No.	blade / ostrze (mm)	
76621	75	10/100

PL Nóż monterski CZ Montážní nůž
 GB Cable knife RO Cutit pt. decablat
 D Montagmesser H Szerelőkés
 RUS Нож электрика E Cuchillo de montaje



No.	type	
76640	K-506	50

PL Nóż sierpak CZ Dřevěný nůž srpek
 GB Cable knife RO Cutit secera maner lemn
 D Klappmesser H Hajított pengéjű kés, fanyelű
 RUS Нож садовый E Cuchillo falciforme de madera



No.	type	
76660	K-394	50

PL Ostrza zapasowe do 76000 CZ Lomené ostří náhradní
 GB Spare blades for 76000 RO Lama rezerva pt. cutter metallic
 D Ersatz-Kurzklingen 5TLG. für 76000/ H Törhető tartalékpenge
 RUS Запасные лезвия для ножа 76000 E Filos de recambio para cutter univers.



VOREL

No.	blade / ostrze (mm)	for / dla	
76010	61x19	76000, 76011, 76015	100/600

PL Nóż instalacyjny z magazynkiem
 GB Cutting knife with blade compartment
 D Universalmesser
 RUS Нож обрeзинный

CZ Univerzální nůž
 RO Cutter cu maner metalic si compartiment pt. rezerve
 H Univerzálnis kés
 E Cutter con cargador



No.	blade / ostrze (mm)	
76011	61x19	12/72

PL Nożyk z ostrzem lamany
 GB Metal utility knife
 D Messer mit Abbrechklingen
 RUS Нож пистолетный

CZ Univerzální nůž
 RO Cutter universal
 H Univerzálnis kés
 E Cuchill con filo partido



No.	blade / ostrze (mm)	
76160	9	24/288

PL Nożyk z ostrzem lamany
 GB Metal utility knife
 D Messer mit Abbrechklingen
 RUS Нож пистолетный

CZ Univerzální nůž
 RO Cutter universal
 H Univerzálnis kés
 E Cuchill con filo partido



No.	blade / ostrze (mm)	
76180	18	40/400

PL Nożyk z ostrzem lamany
 GB Metal utility knife
 D Messer mit Abbrechklingen
 RUS Нож пистолетный

CZ Univerzální nůž
 RO Cutter universal
 H Univerzálnis kés
 E Cuchill con filo partido



No.	blade / ostrze (mm)	
76181	18	50/400

PL Nożyk z ostrzem trapezowym
 GB Utility knife
 D Universalmesser
 RUS Нож универсальный

CZ Univerzální nůž
 RO Cutter universal
 H Univerzálnis kés
 E Cutter con filo trapezoidal

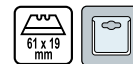

No.	blade / ostrze (mm)	
76015	61x19	12/72

PL Nożyk z ostrzem lamany
 GB Metal utility knife
 D Messer mit Abbrechklingen
 RUS Нож пистолетный

CZ Univerzální nůž
 RO Cutter universal
 H Univerzálnis kés
 E Cuchill con filo partido

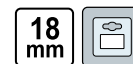

No.	blade / ostrze (mm)	
76184	18	12/120

PL Nożyk z ostrzem lamany
 GB Metal utility knife
 D Messer mit Abbrechklingen
 RUS Нож пистолетный

CZ Univerzální nůž
 RO Cutter universal
 H Univerzálnis kés
 E Cuchill con filo partido



No.	blade / ostrze (mm)	
76185	18	60/600

PL Nożyk z ostrzem lamany
 GB Metal utility knife
 D Messer mit Abbrechklingen
 RUS Нож пистолетный

CZ Univerzální nůž
 RO Cutter universal
 H Univerzálnis kés
 E Cuchill con filo partido



No.	blade / ostrze (mm)	
76182	18	24/240

PL Nożyk z ostrzem lamany
GB Metal utility knife
D Messer mit Abbrechklingen
RUS Нож пистолетный

CZ Univerzální nůž
RO Cutter universal
H Univerzálnis kés
E Cuchill con filo partido



No.	blade / ostrze (mm)	box
76183	18	24/144

PL Ostrza zapasowe do nożyka
GB Spare blades
D Abbrechklingen
RUS Запасные лезвия

CZ Lomené ostří náhradní
RO Lame de rezerva pt. cutter
H Törhető tartalékpenge
E Filo partido de recambio



No.	W (mm)	pcs packing	box
76214	25	5	36/288

No.	W (mm)	pcs packing	box
76210	9	5	100/600
76220	18	5	100/600

PL Komplet nożyków
GB All purpose knife set
D Messersatz
RUS Набор ножей и скребков

CZ Nůže na tapety
RO Set cuttere
H Tapétaolló
E Juego de cuchillos



No.	pcs	box
76250	5	30/150

PL Skrobak do szyb
GB Window scraper
D Glasschaber
RUS Скребок для краски

CZ Škrábák na skla
RO Răzuitor pt. geamuri
H Kaparó üveghez
E Rascador de vidrio



No.	blade / ostrze (mm)	box
06820	60	50/200

PL Nożyk z ostrzem lamany
GB Metal utility knife
D Messer mit Abbrechklingen
RUS Нож пистолетный

CZ Univerzální nůž
RO Cutter universal
H Univerzálnis kés
E Cuchill con filo partido



No.	blade / ostrze (mm)	box
76190	25	12/72

PL Komplet nożyków
GB Utility knife set
D Universalmessersatz
RUS Ножи пистолетные

CZ Nůže na tapety
RO Set cuttere
H Tapétaolló
E Cuchill con filo partido



No.	pcs	box
76230	3	50/200

PL Komplet nożyków
GB All purpose knife set
D Messersatz
RUS Набор ножей и скребков

CZ Nůže na tapety
RO Set cuttere
H Tapétaolló
E Juego de cuchillos



No.	pcs	box
76280	8	25/100

PL Nóż do szkła
GB Glass cutter
D Glasschneider
RUS Стеклопоя

CZ Nůž do skla
RO Diamant pt. sticlă
H Kés üveghez
E Cuchillo para cristal



No.	box
05100	12/240

PL Nóż olejowy do szkła
GB Oil glass cutter
D Ölglasschneider
RUS Стеклопорец масляный

CZ Nůž olejový do skla
RO Diamant cu ulei pt. sticlă
H Olajkés üveghez
E Cuchillo de aceite para cristal



No.		
05050		6/120

PL Punktak automatyczny
GB Automatic center punch
D Automatischer Körner Einstellbare
RUS Автоматический кернер

CZ Automatické důlčikem
RO Automat centru de pumn
H Automatikus központ puncs
E Sacador de centro automático



VOREL

No.	L (mm)	
35240	140	12/72

PL Komplet nożyków precyzyjnych z ostrzami
GB Wood carving knife set
D Präzisionsmessersatz
RUS Набор ножей для резбы по дереву

CZ Sada přesných nožů s břity
RO Set cutite prelucrare lemn
H Modellező késkészlet pengékkel
E Juego de cutters precisos con cuchillos



No.	pcs	
76305	16	25/100

PL Nożyczki
GB Scissors
D Haushaltsschere
RUS Ножницы

CZ Nůžky
RO Foarfece
H Olló
E Tijeras



VOREL

No.	L (mm)	
76312	220	12/144

PL Rysik traserski
GB Scriber
D Reißnadel
RUS Чертилка по металлу

CZ Rysovací jehla
RO Ac detrasat
H Karctu
E Trazador



VOREL

No.	L (mm)	
35210	140	12/72

PL Cyklina ręczna, drewniana
GB Double edge scraper
D Schaber
RUS Циклевка с деревянной ручкой

CZ Dřevěná hobliarka ruční
RO Rascheta dubla (maner lemn)
H Kézi, fa simító
E Rascador manual de madera



No.	mm	
06840	40	10
06860	60	10

PL Nożyczki
GB Scissors
D Haushaltsschere
RUS Ножницы

CZ Nůžky
RO Foarfece
H Olló
E Tijeras



VOREL

No.	L (mm)	
76311	170	12/144

PL Komplet nożyczek
GB Scissors set
D Haushaltsscherensatz
RUS Ножницы бытовые в наборе

CZ Univerzální nůžky
RO Foarfece universal
H Univerzális olló
E Tijeras universales



VOREL

No.	L (mm)	pcs	
76314	140; 170; 190; 220; 250	5	12/24

- PL Dziurkacz nastawny CZ Dėrovací kleštė nastavitelnė
 GB Leather hole punch RO Perforator ajustabil
 D Einstellbarer Locher H llıthtı lyukaszt
 RUS Дырokol пистолетный E Pinza perforadora ajustable

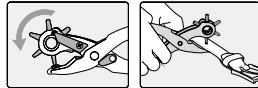

No.	L (mm)	
43600	220	6/36

- PL Praska do zaciskania nap CZ Pliers pro plastov nezapadne
 GB Pliers for plastic snaps RO Plastic pliers pt. sporturi
 D Zange fr Plastic Moschettoni H Fog manyag pattan
 RUS Клещи для пластиковых защелки E Alicates para la snaps de plstico



No.	 (mm)	
76710	10; 12; 14	30/60

- PL Komplet przebijakw do skry CZ Sada prbojnik na kzi
 GB Punch set RO Set producele
 D Lederlocher set H Brylukaszt kszlet
 RUS Набор пробойников для кожи E Juego de perforar en piel



No.	 (mm)	
76700	2; 2.5; 3.2; 4; 4.8; 5.5; 6.4; 8; 9.5; 11.1; 12.7; 14; 15.8; 19; 22	5/20

- PL Strug drewniany CZ Dřevny hoblik
 GB Wood plane RO Rindea de lemn
 D Putzhobel H Fagyalu
 RUS Рубанок отборник деревянный E Cepillo de madera



No.	blade width / szeroko ostrza (mm)	type	
25860	45	fine / gldzik	30
25880	45	course / rwniak	30

- PL Zestaw kaletniczy CZ Dėrovačka na psky
 GB Leather hole punch RO Set clesti prelucrare piele
 D & grommet setting tool kit H Szegecsel s lyukaszt kszlet
 E Kit de cuero herramientas neumticos de perforacin y ojl

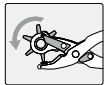
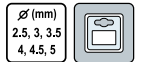
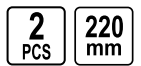

No.	
43603	5/20

- PL Komplet przebijakw do skry CZ Sada prbojnik na kzi
 GB Punch set RO Set producele
 D Lederlocher set H Brylukaszt kszlet
 RUS Набор пробойников для кожи E Juego de perforar en piel



No.	 (mm)	
76705	2.5; 3; 4; 5; 6; 7; 8; 9; 10	10/80

- PL Strug kanik, czolowy CZ Hoblik elni drzkovnik
 GB Rabbet plane RO Rindea frontal unghiarr
 D Simshobel H Prknygylu, homlok
 RUS Фальцгельбель двойной деревянный E Cepillo de ranura



No.	mm	
25830	245x30	20

- PL Pilnik do metalu CZ Pilnik na kov
 GB Steel file RO Pila otel
 D Werkstattfeile H Fmreszel
 RUS Напильник слесарный E Lima de metalo



No.	L (mm)	
25160	200	20/100

PL Pilnik do metalu
GB Steel file
D Werkstattfeile
RUS Напильник слесарный

CZ Pilník na kov
RO Pila oțel
H Fémreszelő
E Lima de metalo



No.	L (mm)	
25161	200	20/100

PL Pilnik do metalu
GB Steel file
D Werkstattfeile
RUS Напильник слесарный

CZ Pilník na kov
RO Pila oțel
H Fémreszelő
E Lima de metalo



No.	L (mm)	
25163	200	20/100

PL Komplet pilników do metalu
GB Steel file set
D Werkstattfeilensatz
RUS Набор напильников

CZ Sada pilníků na kov
RO Set pile oțel
H Fémreszelő készlet
E Juego de limas para metalo

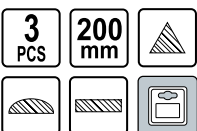

No.	L (mm)	pcs	
25165	200	3	10/20

PL Zestaw pilników do metalu „igłaki”
GB Needle file set
D Schlüsselfeilensatz
RUS Набор напильников

CZ Pilníky na kov jehlové
RO Set de pile lemni - metal
H Tűreszelő készlet fémhez
E Limas de metalo agujas



No.	L (mm)	pcs	packing	
25370	4x150	5		20/200
25380	4x150	10		25/100
25390	4x150	12		25/100

PL Pilnik do metalu
GB Steel file
D Werkstattfeile
RUS Напильник слесарный

CZ Pilník na kov
RO Pila oțel
H Fémreszelő
E Lima de metalo



No.	L (mm)	
25162	200	20/100

PL Pilnik do metalu
GB Steel file
D Werkstattfeile
RUS Напильник слесарный

CZ Pilník na kov
RO Pila oțel
H Fémreszelő
E Lima de metalo



No.	L (mm)	
25164	200	20/100

PL Komplet pilników do metalu
GB Steel file set
D Werkstattfeilensatz
RUS Набор напильников

CZ Sada pilníků na kov
RO Set pile oțel
H Fémreszelő készlet
E Juego de limas para metalo

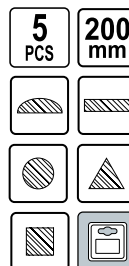

No.	L (mm)	pcs	
25166	200	5	10/20

PL Zestaw pilników do metalu „igłaki”
GB Needle file set
D Schlüsselfeilensatz
RUS Набор напильников

CZ Pilníky na kov jehlové
RO Set de pile lemni - metal
H Tűreszelő készlet fémhez
E Limas de metalo agujas



No.	pcs	
25360	6	20/200

PL Zestaw pilników do metalu „igłaki”
 GB Needle file set
 D Schlüsselzeileinsatz
 RUS Набор напильей

CZ Pilníky na kov jehlové
 RO Set de pile lemn - metal
 H Tűreszelő készlet fémhez
 E Limas de metalo agujas



VOREL

No.	L (mm)	pcs	☐
25351	140	6	20/160
25352	160	6	20/160
25353	180	6	20/120

PL Tarnik do drewna
 GB Wood rasp
 D Holzraspel
 RUS Рашиль

CZ Rašple do dřeva
 RO Pile pt. lemn
 H Fareszelő
 E Escarpelo para madera



VOREL

No.	L (mm)	☐
25171	200	20/100

PL Komplet tarników do drewna
 GB Wood rasp set
 D Holzraspelsatz
 RUS Набор рашпелей

CZ Rašple do dřeva
 RO Set pile pt. lemn
 H Fărăspoly készlet
 E Juego de escarpelos para madera

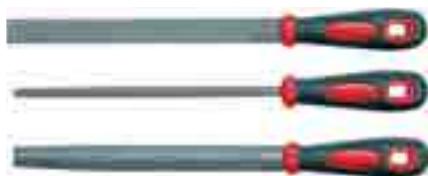

VOREL

No.	L (mm)	pcs	☐
25173	200	3	10/20

PL Tarnik do gipsu
 GB Rasp for plaster
 D Gipskartonplatten Rasp
 RUS Рашиль для гипскартона

CZ Rašple pro omítky
 RO Rasp pentru tencuiala
 H Reszelt vakolat
 E Eliminador de yeso

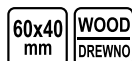

VOREL

No.	size / rozmiar (mm)	☐
25300	60x40	10/60

PL Tarnik do drewna
 GB Wood rasp
 D Holzraspel
 RUS Рашиль

CZ Rašple do dřeva
 RO Pile pt. lemn
 H Fareszelő
 E Escarpelo para madera



VOREL

No.	L (mm)	☐
25170	200	20/100

PL Tarnik do drewna
 GB Wood rasp
 D Holzraspel
 RUS Рашиль

CZ Rašple do dřeva
 RO Pile pt. lemn
 H Fareszelő
 E Escarpelo para madera



VOREL

No.	L (mm)	☐
25172	200	20/100

PL Komplet tarników do drewna
 GB Wood rasp set
 D Holzraspelsatz
 RUS Набор рашпелей

CZ Rašple do dřeva
 RO Set pile pt. lemn
 H Fărăspoly készlet
 E Juego de escarpelos para madera



No.	L (mm)	pcs	☐
25230	200	3	15/60

PL Tarka zapasowa do tarnika
 GB Blade for rasp
 D Sägeblattersatz
 RUS Лезвие для рашпиля по гипскартону

CZ Čepel do škrabacích
 RO Lama pentru rasp
 H Penge reszeltő
 E Hoja para raspar



VOREL

No.	size / rozmiar (mm)	for / dla	☐
25301	60x40	25300	10/120

PL Tarnik do gipsu
GB Rasp for plaster
D Gipskartonplatten Rasp
RUS Рашиль для гипсокартона

CZ Rašple pro omítky
RO Rasp pentru tencuiala
H Reszelt vakolat
E Eliminador de yeso

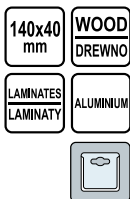

VOREL

No.	size / rozmiar (mm)	
25307	140x40	15/60

PL Oselka
GB Sharpening stone
D Abziehstein
RUS Брусок

CZ Obtahovací brousek
RO Pila abraziva pt. ascuțit
H Fenőkő
E Piedra de afilar



No.	L (mm)	
26150	150	25/50
26200	200	25/50

PL Ostrzarka do noży
GB Knife sharpener
D Messerschärfer
RUS Точилка для ножей

CZ Brousek na nože
RO Cutit ascuțitoare
H Késélező
E Afilador de cuchillos



VOREL

No.		
26220		12/96

PL Papier ścierny wodoodporny
GB Waterproof sand paper
D Schleifpapier wasserfest
RUS Бумага наждачная-водостойкая

CZ Smirkový papír vodní
RO Hartie abraziva rezistentă la apă
H Csiszolópapír vízes
E Papel de lija resistente al agua



No.	mm	pcs packing	
07050	230x280	15	80

PL Tarnik do gipsu
GB Rasp for plaster
D Gipskartonplatten Rasp
RUS Рашиль для гипсокартона

CZ Rašple pro omítky
RO Rasp pentru tencuiala
H Reszelt vakolat
E Eliminador de yeso

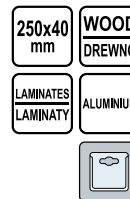

VOREL

No.	size / rozmiar (mm)	
25310	250x40	15/60

PL Oselka owalna
GB Sharpening stone
D Abziehstein
RUS Брусок

CZ Obtahovací brousek
RO Pila abraziva pt. ascuțit
H Fenőkő
E Piedra de afilar



No.	L (mm)	
26210	225	50/100

PL Ostrzarka do wiertarki
GB Rotary sharpener
D Bohrschärfer-Bohrmaschinenaufsatz
RUS Точило для ножей и ножниц

CZ Brousek na nože a nůžky
RO Rezerva pt dispozitiv de ascuțit burghie
H Élezőkő fűrőgéphe fogható
E Muela afilar cuchillos y tijeras

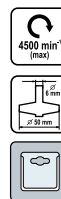

VOREL

No.		
26225		80/240

PL Papier ścierny wodoodporny
GB Waterproof sand paper
D Schleifpapier wasserfest
RUS Бумага наждачная-водостойкая

CZ Smirkový papír vodní
RO Hartie abraziva rezistentă la apă
H Csiszolópapír vízes
E Papel de lija resistente al agua



No.	type	mm	pcs packing	
07060	P60	230x280	50	1000
07080	P80	230x280	50	1000
07100	P100	230x280	50	1000

>>>

PL Papier ścierny wodoodporny
GB Waterproof sand paper
D Schleifpapier wasserfest
RUS Бумага наждачная-водостойкая

CZ Smirkový papír vodní
RO Hartie abraziva rezistentă la apă
H Csiszolópapír vizes
E Papel de lija resistente al agua

50
PCS230x280
mm

No.	type	mm	pcs packing	
07120	P120	230x280	50	1000
07180	P180	230x280	50	1000
07240	P240	230x280	50	1000
07320	P320	230x280	50	1000
07400	P400	230x280	50	1000
07506	P600	230x280	50	1000
07508	P800	230x280	50	1000
07510	P1000	230x280	50	1000
07512	P1200	230x280	50	1000

PL Siatka ścierna
GB Abrasive mesh
D Schleifgitter
RUS Шлифовальная сетка

CZ Brusné pletivo
RO Plasă abrazivă
H Csiszolóháló
E Red abrasiva nacional

105x280
mm

No.	type	mm	
07879	P40	105x280	50
07880	P60	105x280	50
07881	P80	105x280	50
07882	P100	105x280	50
07883	P120	105x280	50
07884	P150	105x280	50
07885	P180	105x280	50
07886	P220	105x280	50

PL Kostka ścierna
GB Abrasive sponge
D Schleifschwamm
RUS Губка для шлифования

CZ Hubka brusná
RO Burete abraziv
H Dörzsszivacs
E Esponja abrasiva

68x100x25
mmALOXITE COATING
NASYP
ELEKTROKORUND

VOREL

No.	type	mm	
08288	P60	68x100x25	50
08289	P80	68x100x25	50
08290	P100	68x100x25	50
08291	P120	68x100x25	50
08292	P150	68x100x25	50
08293	P180	68x100x25	50

PL Płótno ścierne
GB Abrasive cloth
D Schleifgewebe
RUS Бумага наждачная
на тканевой основе

CZ Brusné plátno
RO Pânză abrazivă
H Csiszolóvászon
E Paño abrasivo

50
PCS230x280
mm

No.	type	mm	pcs packing	
07530	P36	230x280	50	500
07540	P46	230x280	50	500
07560	P60	230x280	50	500
07580	P80	230x280	50	500
07610	P100	230x280	50	500
07620	P120	230x280	50	500
07630	P150	230x280	50	500

PL Taśma ścierna bezkońcowa
GB No end abrasive band
D Schleifband
RUS Лента шлифовальная бесконечная

CZ Pás brusný nekonečný
RO Banda abrazivă
H Végtelenített csiszolószalag
E Banda abrasiva sin extremos

5
PCS75x533
mm

VOREL

No.	type	mm	pcs packing	
07664	P40	75x533	5	20/60
07665	P60	75x533	5	20/60
07666	P80	75x533	5	20/60
07667	P100	75x533	5	20/60
07668	P120	75x533	5	20/60

PL Gąbka ścierna
GB Abrasive sponge
D Schleifschwamm
RUS Шлифовальная сетка

CZ Hubka brusná
RO Burete abraziv
H Dörzsszivacs
E Esponja abrasiva

124x98x12
mmALOXITE COATING
NASYP
ELEKTROKORUND

VOREL

No.	type	mm	
07910	P46	124x98x12	100
07911	P60	124x98x12	100
07912	P80	124x98x12	100
07913	P100	124x98x12	100
07914	P120	124x98x12	100
07915	P150	124x98x12	100
07916	P180	124x98x12	100

- PL Kostka ścierna CZ Hubka brusná
 GB Abrasive sponge RO Burete abraziv
 D Schleifschwamm H Dörzsszivacs
 RUS Шлифовальная сетка E Esponja abrasiva



125x90x65x25
mm

ALOXITE COATING
NASYP
ELEKTROKORUND



No.	type	mm	pcs	packing
08301	P60	125x90x65x25	100	
08302	P80	125x90x65x25	100	
08303	P100	125x90x65x25	100	
08304	P120	125x90x65x25	100	
08306	P150	125x90x65x25	100	
08307	P180	125x90x65x25	100	
08308	P220	125x90x65x25	100	

8

- PL Krążek ścierny z otworami
 GB Abrasive disc with holes with velcro
 D Fiberschleifscheiben gelocht
 RUS Круг шлифовальный перфорированный для липучки
 CZ Brusný kotouč z otvorami
 RO Disc abraziv cu orificii
 H Csiszolótárcsa /tapadókoronggal/
 E Juego de discos abrasivos con agujeros

5 PCS 125 Ømm

HOOK FASTENER Z RZEPEM



No.	type	Ø (mm)	pcs	packing
08573	P36	125	5	50/200
08574	P40	125	5	50/200
08576	P60	125	5	50/200
08578	P80	125	5	50/200
08580	P100	125	5	50/200
08582	P120	125	5	50/200
08585	P150	125	5	50/200

- PL Blok ścierny gumowy CZ Brusný blok pryžový
 GB Sanding block RO Suport smirghel
 D Gummischleifklotz H Csiszolóblokk, gumi
 RUS Брусок для шлифования резиновый E Bloque abrasivo de goma

70x125 mm



No.	mm	pcs	packing
07920	70x125	15/60	

- PL Krążek ścierny z rzepem CZ Brusný kotouč /zip/
 GB Abrasive disc with velcro RO Disc abraziv (scai)
 D Fiberschleifscheiben ungelocht H Csiszolótárcsa /tapadókoronggal/
 RUS Круг шлифовальный на липучке E Juego de discos abrasivos /velcro/

5 PCS HOOK FASTENER Z RZEPEM

125 Ømm



No.	type	Ø (mm)	pcs	packing
08553	P36	125	5	50/200
08554	P40	125	5	50/200
08556	P60	125	5	50/200
08558	P80	125	5	50/200
08560	P100	125	5	50/200
08562	P120	125	5	50/200
08565	P150	125	5	50/200

- PL Arkusze ścierny z otworami
 GB Abrasive sheets with holes
 D Schleifbogen gelocht
 RUS Шлифовальная бумага перфорированная
 CZ Brusné archy /z otvorami/
 RO Hartie abraziva cu orificii
 H Csiszolólv /lyukakkal/
 E Ojas abrasivas /con agujer/

5 PCS 93x240 mm



No.	type	mm	pcs	packing
08533	P36	93x240	5	50/200
08534	P40	93x240	5	50/200
08536	P60	93x240	5	50/200
08538	P80	93x240	5	50/200
08540	P100	93x240	5	50/200
08542	P120	93x240	5	50/200
08545	P150	93x240	5	50/200

- PL Blok ścierny CZ Brusný blok
 GB Sanding block RO Suport smirghel
 D Handschleifer H Csiszolóblokk
 RUS Брусок для шлифования E Bloque abrasivo



No.	mm	pcs	packing
07950	85x160	20/100	

No.	mm	pcs	packing
07970	100x210	20/80	

PL Blok ścierny skręcany
 GB Sanding block
 D Handschleifer
 RUS Тёрка для шлифования

CZ Brusný blok
 RO Suport smirghel
 H Csiszolóblokk
 E Bloque abrasivo

220x100
mm



No.
07960

mm
220x100

30

PL Blok ścierny zatrząsk
 GB Sanding block
 D Handschleifer
 RUS Тёрка для шлифования

CZ Brusný blok
 RO Suport smirghel
 H Csiszolóblokk
 E Bloque abrasivo

210x100
mm



No.
07962

mm
210x100

30

8

Memo



9

Hydraulic tools Narzędzia hydrauliczne



Ratchet die stocks
Komplety gwintownic ręcznych
.....114 

Hinged pipe vices
Imadła zaciskowe do rur
.....114 

Water pump pliers
Szczypce nastawne
.....114 

Pipe wrenches
Klucze do rur
.....114-115 

Pipe wrenches Stillson type
Klucze do rur typu Stillson..... 114

Adjustable pipe wrenches
Klucze do rur nastawne..... 115

Adjustable wrenches
Klucze nastawne francuskie..... 115

Chain pipe wrenches
Klucze do rur łańcuchowe
.....115 

Pipe cutters
Obcinaki do rur
.....116 

Calibrators
Kalibratory
.....116 

Pipe welders
Zgrzewarki do rur
.....116-117 

Burners & soldering tools
Palniki i lutownice
.....117-118 

Hydraulic accessories
Akcesoria hydrauliczne
.....118-119 

- PL Zestaw narzędzi hydraulicznych
 GB Plumbing tool set
 D Hydraulischer Werkzeugkasten
 RUS Набор сантехнического инструмента
- CZ Soustava hydraulických nářadí
 RO Trusa instalator pt. tevi
 H Csőszerező szerszámkészlet
 E Juego de herramientas de fontanero

12
PCS



No.	size / rozmiar	pcs	
55800	1/4" (6.3 mm); 3/8" (10.0 mm); 1/2" (12.5 mm); 3/4" (19.0 mm); 1" (25.0 mm); 5/4" (32.0 mm)	12	2

- PL Zestaw gwintownic
 GB Ratchet die stock
 D Schneidkluppensatz
 RUS Набор резьбонарезной сантехнический
- CZ Sada závitníků
 RO Set de filiere
 H Menetfúró készlet
 E Juego de rosacar

6
PCS



- PL Zestaw gwintownic
 GB Ratchet die stock
 D Schneidkluppensatz
 RUS Набор резьбонарезной сантехнический
- CZ Sada závitníků
 RO Set de filiere
 H Menetfúró készlet
 E Juego de rosacar

8
PCS



No.	size / rozmiar	pcs	
55820	3/8" (10.0 mm); 1/2" (12.5 mm); 3/4" (19.0 mm); 1" (25.0 mm); 5/4" (32.0 mm)	8	4

9

- PL Zestaw gwintownic
 GB Ratchet die stock
 D Schneidkluppensatz
 RUS Набор резьбонарезной сантехнический
- CZ Sada závitníků
 RO Set de filiere
 H Menetfúró készlet
 E Juego de rosacar

6
PCS



No.	size / rozmiar	pcs	
55830	1-1/2" (38 mm); 2" (50 mm)	6	2

- PL Szczypce hydrauliczne nastawne
 GB Water pump pliers
 D Wasserpumpenzange
 RUS Ключи переставные
- CZ Keleště siko
 RO Clește papagal
 H Vízpumpafágó
 E Alicates de fontanero ajustables

250
mm

9mm
JAWS WIDTH
GRUBEST SCREW

7
POSITIONS
POZYCJI



No.	L (mm)	
41510	250	10/50



No.	mm	
36570	13-50	6

- PL Klucz do rur
 GB Pipe wrench
 D Rohrschlüssel
 RUS Ключ трубный
- CZ Klíč součásti na trubky
 RO Cheie reglabila pt. tevi
 H Csőkulcs
 E Llave de fontanero



No.	L (mm)	
55250	250	6/48
55300	300	6/36
55350	350	6/24

PL Klucz do rur
GB Pipe wrench
D Rohrschlüssel
RUS Ключ трубный

CZ Klíč součásti na trubky
RO Cheie pt. țevi
H Csőkulcs
E Llave de fontanero



No.	L (mm)	
55620	200	6/36
55625	250	6/30
55630	300	6/36
55635	350	6/24
55645	450	4/16
55660	600	2/6
55690	900	2/6

PL Klucz nastawny do rur
GB Adjustable pipe wrench
D Rohrschlüssel
RUS Ключ трубный

CZ Nastavitelný klíč na trubky
RO Cheie reglabilă pt. țevi
H Állítható csőkulcs
E Llave de vaso para tubería



No.	size / rozmiar	
55215	1.0" (25 mm)	24
55216	1.5" (38 mm)	16
55217	2.0" (50 mm)	8

PL Klucz nastawny francuski
GB Adjustable wrench
D Stahlschraubenschlüssel /franzose/
RUS Ключ разводной

CZ Nastavitelný klíč francouz
RO Cheie reglabilă franceză
H Állítható franciakulcs
E Llave ajustable inglesa



No.	KNF	jaws range / zakres szczęk (mm)	jaws width / szerokość szczęk (mm)	
54499	45	0-45	80	10
54500	55	0-55	90	5
54510	65	0-65	100	5

PL Klucz nastawny do rur
GB Adjustable pipe wrench
D Rohrschlüssel
RUS Ключ трубный

CZ Nastavitelný klíč na trubky
RO Cheie reglabilă pt. țevi
H Állítható csőkulcs
E Llave de vaso para tubería



No.	size / rozmiar	
55100	1.0" (25 mm)	12/36
55150	1.5" (38 mm)	10/20
55200	2.0" (50 mm)	6/12

PL Klucz nastawny do rur
GB Adjustable pipe wrench
D Rohrschlüssel
RUS Ключ трубный

CZ Nastavitelný klíč na trubky
RO Cheie reglabilă pt. țevi
H Állítható csőkulcs
E Llave de vaso para tubería



No.	size / rozmiar	
55210	1.0" (25 mm)	24
55211	1.5" (38 mm)	16
55212	2.0" (50 mm)	8

PL Klucz nastawny do rur
GB Adjustable pipe wrench
D Rohrschlüssel
RUS Ключ трубный

CZ Nastavitelný klíč na trubky
RO Cheie reglabilă pt. țevi
H Állítható csőkulcs
E Llave de vaso para tubería



No.	size / rozmiar	
55220	1.0" (25 mm)	24
55221	1.5" (38 mm)	16
55222	2.0" (50 mm)	8

PL Klucz łańcuchowy do rur
GB Chain pipe wrench
D Kettenrohrzange
RUS Цепной ключ для труб

CZ Klíč řetězový na trubky
RO Cheie reglabilă pt. țevi cu lant
H Láncos csőfogó
E Llave de cadena



No.	L (mm)	max. pipe diameter / max. średnica rury	
55792	300	4" (100 mm)	10/30

9

PL Obcinak do rur
GB Pipe cutter
D Rohrabscneider
RUS Труборез для труб из цветных металлов

CZ Řezač trubek
RO Clește pt. tăiat țevi
H Csővágó olló csövekhez
E Cortatubos

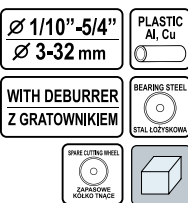

No.	Ø mm	
78381	1/10"-5/4" (3-32 mm)	60

PL Przecinak do rur PCV
GB PVC pipe cutter
D PVC Rohrabscneider
RUS Труборез для пластиковых труб

CZ Řezač PVC trubek
RO Clește pt. tăiat țevi din PVC
H Csővágó olló PVC csövekhez
E Cortatubos PVC para

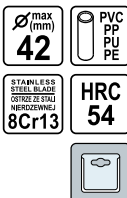

No.	max (mm)	
78341	42	12/48

PL Zgrzewarka do rur termoplastycznych
GB PVC plastic pipe welder
D Schweissgerät für thermoplastische Rohre
RUS Аппарат для сварки пластиковых труб

CZ Svářečka na termoplastické trubky
RO Hegesztő berendezés termoplasztikus csövekhez
H Masina de sudat țevi termoplastice
E Maquina de soldar las tubos termoplasticos



No.	W	
78911	800	5

PL Gratownik do rur
GB Plastic pipe edging tool
D Aussen- und Innentragwerkzeug
RUS Наружный/внутренний гратосниматель

CZ Odhrotovač kombinovaný vnitřní / vnější
RO Dispozitiv pt. sanfen țevi
H Locsolótömlő csatlakozó
E Escariador bilateral de tubos



No.	mm	
78385	6-36	25/50

PL Kalibrator do rur
GB Pipe calibration tool
D Kalibrierer für Mehrschichtverbundrohr
RUS Калибратор пластиковый

CZ Kalibrátor na trubky
RO Calibrator teava multistrat
H Örtétegű cső kalibráló
E Calibrador para tubos multicapa

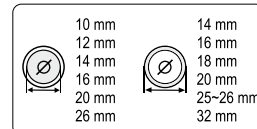
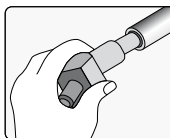
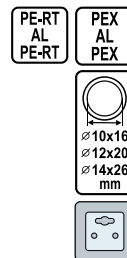

No.		
55740		300

PL Zgrzewarka do rur termoplastycznych
GB PVC plastic pipe welder
D Schweissgerät für thermoplastische Rohre
RUS Аппарат для сварки пластиковых труб

CZ Svářečka na termoplastické trubky
RO Hegesztő berendezés termoplasztikus csövekhez
H Masina de sudat țevi termoplastice
E Maquina de soldar las tubos termoplasticos

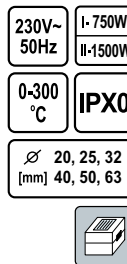

No.	W	
78912	750-1500	4

- PL Zgrzewarka do rur termoplastycznych
- GB PVC plastic pipe welder
- D Schweissgerät für thermoplastische Rohre
- RUS Аппарат для сварки пластиковых труб
- CZ Svářečka na termoplastické trubky
- RO Hegeşzító berendezés termoplasztikus csövekhez
- H Masina de sudat tevi termoplastice
- E Máquina de soldar las tubos termoplasticos

230V~ 50Hz	I-800W II-1500W
0-300 °C	IPX4
∅ 16, 20, 25, 32 [mm] 40, 50, 63	



POWER UP

No.	W	☐
78910	800-1500	5

- PL Lutownica gazowa 3 w 1
- GB Soldering tool 3 in 1
- D Gaslötkolben 3 in 1
- RUS Газовый паяльник 3-в-1
- CZ Plynová pájka 3 in 1
- RO Ciocan de lipit cu gaz 3 in 1
- H Gaz-forrasztópaka 3 in 1
- E Soldador de gas 3 in 1

15 ml	25~80 W	60 min
BUTANE lighter gas BUTAN (gaz do zapalniczki)	GAS GAZ	PROPANE-BUTANE lighter gas PROPAN-BUTAN (gaz do zapalniczki)

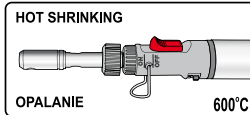
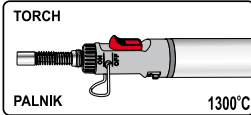
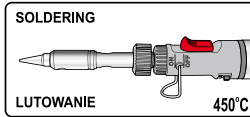

VOREL

No.	W	☐
73410	25 - 80	12/48

- PL Palnik gazowy
- GB Gas blow torch
- D Lötbrenner
- RUS Газовая горелка
- CZ Plynový hořák
- RO Arzator pe gaz
- H Gázégő
- E Soplete de gas

PIEZO	1.3 kW
1300 °C	GAS GAZ
BUTANE BUTAN	☐

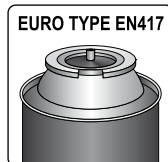

VOREL

No.	kW	☐
73413	1.3	10/60

- PL Palnik gazowy
- GB Gas blow torch
- D Lötbrenner
- RUS Газовая горелка
- CZ Plynový hořák
- RO Arzator pe gaz
- H Gázégő
- E Soplete de gas

0.22 kW	PIEZO	GAS GAZ	BUTANE lighter gas BUTAN (gaz do zapalniczki)
10 g CAPACITY POJEMNOŚĆ	30 min	LOCK BLOKADA	CHILD PROTECTION ZABEZPIECZENIE PRZED DZIECIAMI

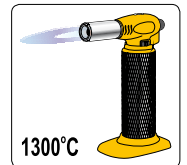

VOREL

No.	kW	☐
73420	0.22	10/60

- PL Palnik gazowy
- GB Gas blow torch
- D Lötbrenner
- RUS Газовая горелка
- CZ Plynový hořák
- RO Arzator pe gaz
- H Gázégő
- E Soplete de gas

PIEZO	1.3 kW	1300 °C
GAS GAZ	BUTANE BUTAN	☐

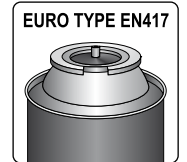

VOREL

No.	kW	☐
73412	1.3	10/60

- PL Gazowa lampa lutownicza
- GB Gas soldering lamp
- D Gaslötlampe
- RUS Газовая паяльная лампа
- CZ Plynová pájčí lampa
- RO Lampă de lipit pe gaz
- H Gázos forrasztólámpa
- E Lampa de gas para soldar

1200°C max.	1.7 kW	123 g/h
CARTRIDGE 190g	BUTAN	COMPOSITE BODY PLASTIC KORPUS



VOREL

No.	kW	☐
73400	1.7	12

- PL Gazowa lampa lutownicza PIEZO
 GB Gas soldering lamp
 D Gaslötlampe
 RUS Лампа паяльная газовая с пьезоподжигом
- CZ Plynová pájecí lampa
 RO Lampă de lipit pe gaz
 H Gázos forrasztólámpa
 E Lampa de gas para soldar

PIEZO ELECTRIC
 1200°C max.
 1.7 kW
 123 g/h
 CARTRIDGE 190g
 BUTAN
 METAL COVER METALOWY KORPUS



No.	kW	
73403	1.7	12

- PL Taśma PTFE
 GB PTFE tape
 D Teflonband
 RUS Фумлента
- CZ Teflonová páska
 RO Bandă de teflon
 H Teflon szalag
 E Cinta de teflón



No.	W (mm)	thickness / grubość (mm)	L (m)	
75201	12	0.1	12	250/1000
75202	19	0.2	15	200

- PL Pasta uszczelniająca do gwintów
 GB Thread sealing paste
 D Paste zum Abdichten der Gewinde
 RUS Паста для герметизации резьбы
 CZ Těsnicí pasta na závity
 RO Pastă etanșantă pt. filet
 H Menettömítő paszta
 E Pasta selladora para roscas

FOR WATER / HEATING / GAS / AIR
 DO WODY / C.O. / GAZU / POWIETRZA



No.	g	
86752	360	48

- PL Hydrauliczny zestaw naprawy
 GB Hydraulic repair kit
 D Hydraulischer Reparatursatz
 RUS Комплект для уплотнения резьбы
- CZ Hydraulická opravářská souprava
 RO Set de reparatii pt. instalatori
 H Vízvezeték javító készlet
 E Juego para reparaciones hidráulicas



No.	g	
86761	100 + 65	40

- PL Taśma PTFE
 GB PTFE tape
 D Teflonband
 RUS Фумлента
- CZ Teflonová páska
 RO Bandă de teflon
 H Teflon szalag
 E Cinta de teflón



No.	W (mm)	thickness / grubość (mm)	L (m)	
75200	12	0.075	10	12/2400

- PL Pasta uszczelniająca do gwintów
 GB Thread sealing paste
 D Paste zum Abdichten der Gewinde
 RUS Паста для герметизации резьбы
 CZ Těsnicí pasta na závity
 RO Pastă etanșantă pt. filet
 H Menettömítő paszta
 E Pasta selladora para roscas

FOR WATER / HEATING / GAS / AIR
 DO WODY / C.O. / GAZU / POWIETRZA



No.	g	
86750	65	48
86751	250	48

- PL Pakuły lniane
 GB Oakum
 D Leinenwerg
 RUS Лен сантехнический
- CZ Lněná koudel
 RO Căști de in
 H Len kóc
 E Estopa de lino



No.	g	
86760	100	50

- PL Pasta poślizgowa do rur PCV
 GB Lubricant for PVC pipes
 D Gleitpaste für PVC-Rohre
 RUS Силиконовая смазка для ПВХ труб
- CZ Kluzná pasta na PVC trubky
 RO Pastă glisantă pt. țevi PVC
 H Sikositő paszta PVC csövekhez
 E Pasta de deslizamiento para tubos de PCV



No.	g	
86770	250	18
86771	500	15

- PL Pistolet do udrażniania rur
- GB Drain cleaner
- D Pistole zum Reinigen von Rohren
- RUS Пневматический пистолет для прочистки труб
- CZ Pistole na čištění trubek
- RO Pistol pt. curățarea țevilor
- H Csőtisztító pisztoly
- E Pistola destapacaños



No.	Ø (mm)	Box
55500	135	10

- PL Przepychacz do udrażniania kanalizacji
- GB Pipe cleaner
- D Räumdom zum Reinigen der Kanalisation
- RUS Трос сантехнический, щетка-ерш для прочистки труб
- CZ Tlakový čistič kanalizace
- RO Piston pt. deblocarea canalizării
- H Lefolyótisztító pumpa
- E Bomba destapacaños



No.	L (cm)	pcs	Box
55531	65	2	36

- PL Spirala kanalizacyjna
- GB Drain auger
- D Hand-Rohrreinigungsspirale
- RUS Трос сантехнический для чистки труб
- CZ Spirála kanalizační
- RO Dispozitiv de desfundat scurgere
- H Csőtisztító spirál
- E Desatascador espiral



No.	Ø (mm)	L (m)	Box
55544	9	5	5/10
55545	9	10	4/8

- PL Pompa do udrażniania kanalizacji
- GB Drain suction pump
- D Hochdruck-Rohrreiner
- RUS Пневматический вантуз для прочистки труб
- CZ Čerpadlo na čištění trubek
- RO Pompă pt. curățarea țevilor
- H Csőtisztító szivattyú
- E El desagüe del fregadero limpiador



No.	Ø (mm)	Box
55505	65; 155	24

- PL Spirala kanalizacyjna
- GB Drain auger
- D Hand-Rohrreinigungsspirale
- RUS Трос сантехнический для чистки труб
- CZ Spirála kanalizační
- RO Dispozitiv de desfundat scurgere
- H Csőtisztító spirál
- E Desatascador espiral



No.	Ø (mm)	L (m)	Box
55541	5	1.5	20/80
55542	6	3	18/36

Memo	
------	--

10

Fastening tools
Narzędzia do łączenia

Hand riveters
Nitownice ręczne

.....122-123

**Hand riveters**

Nitownice ręczne..... 122

Hand riveting tool

Nitownice ręczne, dźwigniowe..... 123

Rivets
Nity

.....123

**Aluminium blind rivets**

Nity aluminiowe..... 123

Profile connection pliers
Szczypce do łączenia profili

.....123

**Staple guns & staples**
Zszywacze i zszywki

.....123-124

**Staple guns**

Zszywacze..... 123

Staple removers

Rozszywacze..... 124

Staples

Zszywki..... 124

Caulking guns
Wyciskacze do mas

.....125

**Foam guns**
Pistolety do pianki montażowej

.....125

**Hose clips**
Opaski ślimakowe

.....126-127

**Cable ties**
Opaski plastikowe

.....127

**Glue sticks & glue applicators**
Wkłady klejowe i dozowniki do kleju

.....127-128

**Packing tape dispensers**
Podajniki taśmy pakowej

.....128

**Tapes**
Taśmy

.....128-131

**Ropes & lines**
Sznury i linki

.....131-132



PL Nitownica ręczna
GB Hand riveter
D Blindnietzange
RUS Заклепочник

CZ Ruční nýtovačka
RO Presă de nituit manuală
H Kézi popszegecshúzó
E Remachadora de mano



No.	L (mm)	Ø (mm)	Box
70000	250	2.4; 3.2; 4.0; 4.8	12/24

PL Nitownica ręczna
GB Hand riveter
D Blindnietzange
RUS Заклепочник

CZ Ruční nýtovačka
RO Presă de nituit manuală
H Kézi popszegecshúzó
E Remachadora de mano



No.	L (mm)	Ø (mm)	Box
70023	250	2.4; 3.2; 4.0; 4.8	12/24

PL Nitownica ręczna
GB Hand riveter
D Blindnietzange
RUS Заклепочник

CZ Ruční nýtovačka
RO Presă de nituit manuală
H Kézi popszegecshúzó
E Remachadora de mano

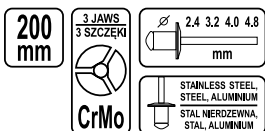

No.	L (mm)	Ø (mm)	Box
70035	200	2.4; 3.2; 4.0; 4.8	30

PL Nitownica ręczna
GB Hand riveter
D Blindnietzange
RUS Заклепочник

CZ Ruční nýtovačka
RO Presă de nituit manuală
E Remachadora de mano



No.	L (mm)	Ø (mm)	Box
70100	280	2.4; 3.2; 4.0; 4.8	12/24

PL Nitownica ręczna
GB Hand riveter
D Blindnietzange
RUS Заклепочник

CZ Ruční nýtovačka
RO Presă de nituit manuală
H Kézi popszegecshúzó
E Remachadora de mano



No.	L (mm)	Ø (mm)	Box
70020	240	2.4; 3.2; 4.0; 4.8	12/24

PL Nitownica ręczna
GB Hand riveter
D Blindnietzange
RUS Заклепочник

CZ Ruční nýtovačka
RO Presă de nituit manuală
H Kézi popszegecshúzó
E Remachadora de mano



No.	L (mm)	Ø (mm)	Box
70030	230	2.4; 3.2; 4.0; 4.8	15/30

PL Nitownica ręczna
GB Hand riveter
D Blindnietzange
RUS Заклепочник

CZ Ruční nýtovačka
RO Presă de nituit manuală
H Kézi popszegecshúzó
E Remachadora de mano

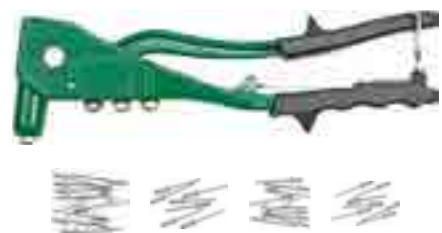

No.	L (mm)	Ø (mm)	Box
70050	250	2.4; 3.2; 4.0; 4.8	12/24

PL Nitownica ręczna
GB Hand riveter
D Blindnietzange
RUS Заклепочник

CZ Ruční nýtovačka
RO Presă de nituit manuală
H Kézi popszegecshúzó
E Remachadora de mano



No.	L (mm)	Ø (mm)	Box
70160	250	2.4; 3.2; 4.0; 4.8	12/24

PL Nitownica ręczna do nitonakrętek
GB Hand nut tool
D Blindnietzange
RUS Заклепочник

CZ Nýtovačka páková
RO Pclește pt. popnrituri
H Emeltyús popszegecsűzű
E Remachadora de palanca

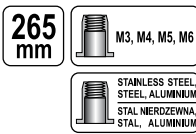

VOREL



No.	L (mm)	size / rozmiar	
70270	265	M3; M4; M5; M6	5/20

PL Nitownica dźwigniowa
GB Hand riveting tool
D Blindnietzange
RUS Заклепочник

CZ Nýtovačka páková
RO Pclește pt. popnrituri
H Emeltyús popszegecsűzű
E Remachadora de palanca



VOREL

No.	L (mm)	Ø (mm)	
70210	400	3.4; 4.0; 4.8	12/24

PL Szczypce do łączenia profili
GB Profile connection pliers
D Zange zum Verbinden der Profile
RUS Щипцы для соединения профилей

CZ Kleště ke spojování profilů
RO Clește pt. imbinarea profilelor
H Profilgyesítő fogó
E Pinzas para conectar perfiles



VOREL

No.	L (mm)	
04300	280	6/36

PL Szczypce do łączenia profili
GB Profile connection pliers
D Zange zum Verbinden der Profile
RUS Щипцы для соединения профилей

CZ Kleště ke spojování profilů
RO Clește pt. imbinarea profilelor
H Profilgyesítő fogó
E Pinzas para conectar perfiles

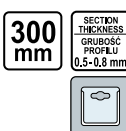

VOREL

No.	L (mm)	
04301	300	6/24

PL Nitownica dźwigniowa
GB Hand riveting tool
D Blindnietzange
RUS Заклепочник

CZ Nýtovačka páková
RO Pclește pt. popnrituri
H Emeltyús popszegecsűzű
E Remachadora de palanca

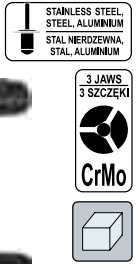
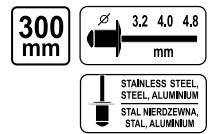

VOREL

No.	L (mm)	Ø (mm)	
70201	300	3.2; 4.0; 4.8	20

PL Nity aluminiowe
GB Aluminium blind rivets
D Aluminiumblindnieten
RUS Заклёпки алюминиевые

CZ Hliníkové nýty
RO Nituri din aluminiu
H Alu popszegecs
E Remaches de aluminio



VOREL

No.	mm	pcs packing	
70320	6.4x3.2	50	25/250
70330	9.6x3.2	50	25/250
70340	12.7x3.2	50	25/250
70400	6.4x4.0	50	25/200
70410	9.6x4.0	50	25/200
70420	12.7x4.0	50	25/200
70430	19.0x4.0	50	25/200
70480	6.4x4.8	50	25/150
70490	9.6x4.8	50	25/150
70500	12.7x4.8	50	25/150
70510	19.0x4.8	50	25/150

PL Zszywacz tapicerski
GB Staple gun
D Tacker
RUS Степлер мебельный
пластиковый корпус

CZ Čalounická sešivačka
RO Capsator tapiterie
H Kárpitos tűzőgép
E Grapadora de tapicero



VOREL

No.	mm	
71000	4-8	10/60

PL Zszywacz tapicerski
GB Staple gun
D Tacker
RUS Стеллер металлический с регулировочным винтом

CZ Čalounická sešivačka
RO Capsator tapiterie
H Kárpitos tűzőgép
E Grapadora de tapicero

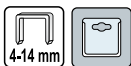

No.	mm	
71050	4-14	10/40

PL Zszywacz tapicerski
GB Staple gun
D Tacker
RUS Стеллер

CZ Čalounická sešivačka
RO Capsator tapiterie
H Kárpitos tűzőgép
E Grapadora de tapicero

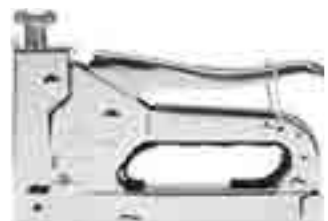

No.	mm	
71052	4-14	10/20

PL Zszywacz młotkowy
GB Hammer tacker
D Schnellnagler
RUS Стреленп

CZ Čalounická sešivačka
RO Capsator tapiterie
H Kárpitos tűzőgép
E Grapadora de martillo

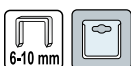

No.	mm	
71080	6-10	6/24

PL Zszywki
GB Staples
D Heftklammern
RUS Скобы

CZ Sešivky
RO Capse tapiterie
H Tűzőkapocs
E Grapas



No.	mm		pcs packing	
72040	4	0.7x11.3	1000	60/480
72060	6	0.7x11.3	1000	60/360
72080	8	0.7x11.3	1000	60/300
72100	10	0.7x11.3	1000	60/240
72120	12	0.7x11.3	1000	50/200
72140	14	0.7x11.3	1000	40/160

PL Zszywacz tapicerski
GB Staple gun
D Tacker
RUS Стеллер металлический

CZ Čalounická sešivačka
RO Capsator tapiterie
H Kárpitos tűzőgép
E Grapadora de tapicero

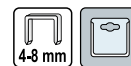

No.	mm	
71040	4-8	10/40

PL Zszywacz tapicerski
GB Staple gun
D Tacker
RUS Стеллер

CZ Čalounická sešivačka
RO Capsator tapiterie
H Kárpitos tűzőgép
E Grapadora de tapicero

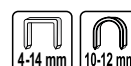

No.		
71060		6/24

PL Rozszywacz
GB Staple remover
D Entkammerer
RUS Расшиватель

CZ Rozešivač
RO Extractor capse
H Kapocsiszede
E Quitagrapas

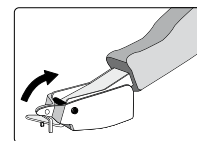

No.		
71160		10/40



PL Wyciskacz do mas
GB Caulking gun
D Kartuschenpistole
RUS Пистолет для герметика

CZ Protlačovač na hmoty
RO Pistol silicon
H Masszakinyomó
E Pistola para masilla

230 mm



No.	mm	
09100	230	20/40

PL Wyciskacz do mas
GB Caulking gun
D Kartuschenpistole
RUS Пистолет для герметика

CZ Protlačovač na hmoty
RO Pistol silicon
H Masszakinyomó
E Pistola para masilla

230 mm



No.	mm	
09150	230	20/40

PL Pistolet do pianki montażowej
GB Foam gun
D Farbspritz-Pistole
RUS Пистолет для монтажной пены

CZ Pistole na montážní pěnu
RO Pistol spuma
H Felrakó pisztoly, poliurethán habhoz
E Pistola para espuma de montaje de metalo



No.		
09170		10/20

PL Pistolet do pianki montażowej
GB Foam gun
D Farbspritz-Pistole
RUS Пистолет для монтажной пены

CZ Pistole na montážní pěnu
RO Pistol spuma
H Felrakó pisztoly, poliurethán habhoz
E Pistola para espuma de montaje de metalo



No.		
09172		10/20

PL Wyciskacz do mas
GB Caulking gun
D Kartuschenpistole
RUS Пистолет для герметика

CZ Protlačovač na hmoty
RO Pistol silicon
H Masszakinyomó
E Pistola para masilla

230 mm



No.	mm	
09130	230	10/20

PL Wyciskacz do mas
GB Caulking gun
D Kartuschenpistole
RUS Пистолет для герметика

CZ Protlačovač na hmoty
RO Pistol silicon
H Masszakinyomó
E Pistola para masilla

230 mm



No.	mm	
09160	230	10/20

PL Pistolet do pianki montażowej
GB Foam gun
D Farbspritz-Pistole
RUS Пистолет для монтажной пены

CZ Pistole na montážní pěnu
RO Pistol spuma
H Felrakó pisztoly, poliurethán habhoz
E Pistola para espuma de montaje de metalo



No.		
09171		10/20

PL Pistolet do pianki montażowej
GB Foam gun
D Farbspritz-Pistole
RUS Пистолет для монтажной пены

CZ Pistole na montážní pěnu
RO Pistol spuma
H Felrakó pisztoly, poliurethán habhoz
E Pistola para espuma de montaje de metalo



No.		
09173		10/20

- PL Opaska ślimakowa z etykieta
 GB Hose clip
 D Schlauchklemme
 RUS Хомут стальной
- CZ Šneková páska
 RO Colier metalic
 H Csigapánt
 E Abrazadora



No.	Ø (mm)	↑ mm	
73515	6-12	7.5	100
73516	8-14	7.5	100
73517	10-16	7.5	100
73521	12-20	9.0	100
73522	16-25	9.0	100
73523	20-32	9.0	100
73525	30-45	9.0	50
73527	40-60	9.0	50
73528	55-70	9.0	50
73529	65-80	9.0	50
73530	75-95	9.0	50
73532	90-110	9.0	50
73533	105-120	9.0	50
73534	115-130	9.0	50
73535	125-140	9.0	50
73536	145-160	9.0	50
73539	175-190	9.0	50
73540	190-205	9.0	50

- PL Komplet opasek ślimakowych
 GB Hose clip set
 D Schlauchklemmensatz
 RUS Набор хомутов
 CZ Sada šnekových pásek
 RO Set coliere metalice
 H Csigapántkészlet
 E Juego de abrazadoras



No.	Ø (mm)	pcs	
73836	25-40	2	40
73838	40-60	2	40

- PL Komplet opasek ślimakowych
 GB Hose clip set
 D Schlauchklemmensatz
 RUS Набор хомутов
- CZ Sada šnekových pásek
 RO Set coliere metalice
 H Csigapántkészlet
 E Juego de abrazadoras



No.	pcs	
73590	8	25

- PL Opaska ślimakowa
 GB Hose clip
 D Schlauchklemme
 RUS Хомут стальной
- CZ Šneková páska
 RO Colier metalic
 H Csigapánt
 E Abrazadora



No.	Ø (mm)	
73561	8-12	100
73562	10-16	100
73563	12-22	100
73565	16-27	100
73567	20-32	100
73568	25-40	100
73569	35-50	50
73570	40-60	50
73571	50-70	50
73572	60-80	25
73573	70-90	25
73574	80-100	25
73575	90-110	25

- PL Komplet opasek ślimakowych
 GB Hose clip set
 D Schlauchklemmensatz
 RUS Набор хомутов
 CZ Sada šnekových pásek
 RO Set coliere metalice
 H Csigapántkészlet
 E Juego de abrazadoras



No.	Ø (mm)	pcs	
73831	8-12	4	4/40
73833	12-22	4	40
73835	20-32	4	40

- PL Komplet serwisowy
 GB Hose clip set
 D Schlauchklemmensatz
 RUS Набор хомутов
- CZ Dělnická sada
 RO Set coliere metalice
 H Szervizkészlet
 E Juego de juntas



No.	pcs	
73598	365	1

PL Opaska ślimakowa
GB Hose clip
D Schlauchklemmen
RUS Хомут стальной

CZ Šňeková páska
RO Colier metalic
H Csigapánt
E Abrazadora



No.	Ø (mm)	☐
73612	6-12	100
73614	8-14	100
73616	10-16	100
73620	12-20	100
73621	14-20	100
73625	16-25	100
73627	18-27	100
73632	20-32	100
73640	25-40	100
73645	35-50	50
73660	40-60	50
73670	55-70	50
73680	65-80	50
73695	75-95	50
73700	80-100	50
73710	90-110	50
73720	105-120	50
73730	115-130	50
73740	125-140	50
73775	160-175	50
73820	205-220	50

PL Opaski plastikowe
GB Cable ties
D Kabelbinder
RUS Хомуты-стяжки пластиковые

CZ Plastiková páska
RO Set coliere din plastic
H Műanyag pánt
E Abrazadoras de plastico

PA 6.6 UL P4V2



No.	mm	max tensile strength / max odporność na zrywanie (kg)	wire bundle max Ø / max Ø wiązki kabli (mm)	pcs packing	☐
73881	80x2.5	8	15	100	250/500
73882	100x2.5	8	20	100	250/500
73883	150x2.5	8	40	100	250/500
73884	200x2.5	8	50	100	125/250
73885	300x3.6	18	80	100	75/150
73906	200x4.8	22	50	100	75/150
73909	280x4.8	22	80	100	50/100
73886	370x4.8	22	100	100	50/100
73887	430x4.8	22	120	100	35/70
73888	500x8.0	54	130	50	30/60

PL Opaska ślimakowa do węży
GB Hose clip
D Schlauchklemme
RUS Хомуты для шлангов

CZ Šňeková páska
RO Colier metalic
H Csigapánt
E Abrazadora



4 PCS



No.	Ø (mm)	for hose / do węży Ø	pcs	☐
73506	12-20	1/2" (12.5 mm)	4	20
73507	16-25	3/4" (19.0 mm)	4	10/20
73508	20-32	1" (25.0 mm)	4	20
73510	12-20	1/2" (12.5 mm)	4	20
73511	16-25	3/4" (19.0 mm)	4	20
	20-32	1" (25.0 mm)	4	20

PL Opaski plastikowe
GB Cable ties
D Kabelbinder
RUS Хомуты-стяжки пластиковые

CZ Plastiková páska
RO Set coliere din plastic
H Műanyag pánt
E Abrazadoras de plastico

PA 6.6 UL P4V2



No.	mm	max tensile strength / max odporność na zrywanie (kg)	wire bundle max Ø / max Ø wiązki kabli (mm)	pcs packing	☐
73891	80x2.5	8	15	100	250/500
73892	100x2.5	8	20	100	250/500
73893	150x2.5	8	40	100	250/500
73894	200x2.5	8	50	100	125/250
73895	300x3.6	18	80	100	75/150
73929	280x4.8	22	80	100	50/100
73896	370x4.8	22	100	100	50/100
73897	430x4.8	22	120	100	35/70
73898	500x8.0	54	130	50	30/60

PL Wkłady klejowe
GB Glue sticks
D Heißklebpatronen
RUS Тубы для клеевого пистолета

CZ Lepicí vložky
RO Articole plastic (pt. pistol lipit)
H Ragasztóbetét
E Cartucho de cola

WORKING TEMPERATURE
TEMPERATURA PRACY
170-200°C

SOFTENING POINT
TEMPERATURA MIEKNIENIA
85+/-2°C

TRANSPARENT
BEZBARWNE

UNIVERSAL
UNIWERSALNE



application: cardboard, wood, plastic, leather, fabrics
zastosowanie: tektura, drewno, plastik, skóra, tkaniny

No.	mm	kg	☐
73300	11x200	1	10

- PL Wkłady klejowe
 GB Glue sticks
 D Heissklebepatronen
 RUS Тубы для клеевого пистолета
- CZ Lepící vložky
 RO Articole plastic (pt. pistol lipit)
 H Ragasztóbetét
 E Cartucho de cola

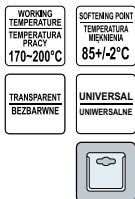

application: cardboard, wood, plastic, leather, fabrics
 zastosowanie: tektura, drewno, plastik, skóra, tkaniny



No.	mm	pcs	
73260	7x100	12	50/200
73270	11x100	6	20/120
73271	11x150	12	20/60

- PL Podajnik taśmy pakowej
 GB Packing tape dispenser
 D Verpackungsband-Abroller
 RUS Диспенсер для клейких лент
- CZ Páskovačka
 RO Pistol cu banda de impachetare
 H Csomagolószalag tépő
 E Precindator de plastic

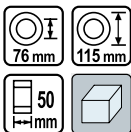

No.	W (mm)	
75295	50	12/24

- PL Taśma pakowa przezroczysta
 GB Packing tape, transparent
 D Verpackungsband aus PP, durchsichtig
 RUS Упаковочная клейкая лента
- CZ Balící páska PP průhledná
 RO Bandă ambalare PP transparentă
 H Áttátszó ragasztószalag
 E Cinta de embalaje PP transparente



No.	W (mm)	L (m)	
75303	48	40	72
75304	48	66	36

- PL Taśma papierowa samoprzylepna
 GB Self adhesive paper tape
 D Papierband selbstklebend
 RUS Лента малярная бумажная
- CZ Páska papírová samolepící
 RO Banda adeziva hartie
 H Öntapadó papírszalag
 E Cinta de papel adhesiva

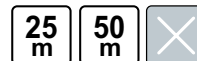

- PL Dozownik kleju
 GB Glue applicator - bottle kit
 D Applikator-Flasche für Flüssigklebstoffe
 RUS Аппликатор клея
 CZ Aplikátor lepidla
 RO Kit aplicator lipici
 H Lamellaragasztó
 E Aplicador de pegamento



No.	
78027	50

- PL Taśma pakowa brązowa
 GB Packing tape, brown
 D Verpackungsband aus PP, braun
 RUS Упаковочная клейкая лента
- CZ Balící páska PP hnědá
 RO Bandă ambalare PP maro
 H PP barna ragasztószalag
 E Cinta de embalaje PP marrón



No.	W (mm)	L (m)	
75301	48	40	72
75302	48	66	36

- PL Taśma pakowa
 GB Packing tape
 D Band
 RUS Упаковочная клейкая лента
- CZ Balící páska
 RO Banda scotch
 H Csomagolószalag
 E Cinta de embalaje



No.	W (mm)	L (m)	
75300	48	45	12/120

No.	W (mm)	L (m)	
75270	19	25	12/48
75271	25	25	36
75272	30	25	10/40
75273	38	25	6/24
75274	48	25	6/24
75285	25	50	9/36
75286	30	50	10/40
75287	38	50	6/24
75288	48	50	6/24

PL Taśma maskująca, niebieska
GB Blue masking tape
D Malerei blau Tape
RUS Малярна стрічка

CZ Maskovací páska
RO Bandă de mascare
H Fedőszalag
E Cinta de enmascarar



No.	W (mm)	L (m)	
75120	30	25	40
75121	38	25	24
75122	48	25	24
75123	30	50	40
75124	38	50	24
75125	48	50	24

PL Taśma dwustronna do wykładzin
GB Double-sided carpet tape
D Doppelseitiges Klebeband für Auslegware
RUS Двухсторонняя клейкая лента для укладки ковровых покрытий
CZ Obojstranná lepicí páska (na podlahové krytiny)
RO Bandă cu două părți adezive pt. mochetă
H Kétoldalas szalag szőnyegpadlóhoz
E Cinta doble cara para alfombras



No.	W (mm)	L (m)	
75260	50	5	48
75261	50	10	36
75262	50	25	24

PL Taśma samoprzylepna dwustronna
GB Mounting tape
D Doppelseitiges montageband
RUS Двухсторонняя монтажная лента
CZ Páska montážní dvouvrstvá
RO Scotch cu banda dubla
H Kétoldalas ragasztószalag
E Cinta adhesiva, ambos lados

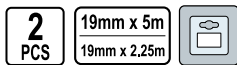

No.	W (mm)	L (m)	
75100	19	2.25/5	12/96

PL Taśma tynkarska elewacyjna
GB Plastering tape
D Putzband
RUS Штукатурные лента

CZ Fasádní omítková páska
RO Banda mascare pt. tencuciei
H Homlokzati festő szalag
E Cinta de escayola

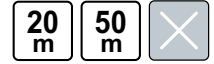

No.	W (mm)	L (m)	
75130	38	20	24
75131	48	20	24
75132	38	50	28
75133	48	50	24

PL Taśma dwustronna na folii
GB Double-sided tape
D Doppelseitiges Band auf PP-Folie
RUS Клейкая лента двухсторонняя на полипропиленовой основе
CZ Obojstranná páska na PP folii
RO Bandă cu două fețe pt. folii
H Kétoldalas
E Cinta doble cara sobre la base de PP



No.	W (mm)	L (m)	
75245	50	5	72
75246	50	10	72
75247	50	25	36

PL Taśma tekstylna „DUCT”
GB „DUCT” tape
D Textilband „DUCT”
RUS Лента армированная на тканевой основе

CZ Textilní páska „DUCT”
RO Bandă textilă „DUCT”
H „DUCT” textil szalag
E Cinta textil „DUCT”



No.	W (mm)	L (m)	
75238	48	10	36
75239	38	50	32
75240	48	50	24

PL Taśma ostrzegawcza
GB Warning tape
D Warnband, kleband
RUS Лента сигнальная

CZ Lepící páska výstražná
RO Bandă adezivă avertizare
H Figyelmeztető ragasztó szalag
E Cinta adhesiva de advertencia



No.	W (mm)	L (m)	
75231	48	33	24

PL Taśma ostrzegawcza dwukolorowa
GB Two-colour warning tape
D Zweifarbiges Warnband
RUS Лента сигнальная

CZ Páska výstražná dvojbarevná
RO Banda de avertizare bicolora
H Kétszínű jelzőszalag
E Cinta de advertencia bicolor



No.	W (mm)	L (m)	
75233	75	100	24

PL Taśma PCV
GB PVC Tape
D PVC Band
RUS Изолента ПВХ

CZ Páska PVC
RO Banda izolatoare PVC
H PVC Szalag
E Cinta PVC



No.	W (mm)	thickness / grubość (mm)	L (m)	pcs. packing	
75000	19	0.13	10	10	50
75050	50	0.13	10	1	25/100

PL Zestaw taśm izolacyjnych PCV
GB Set of PVC insulating tapes
D Satz von PVC-Isolierbändern
RUS Изолента цветная

CZ Sada izolačních pásek PVC
RO Set de benzi de izolare din PVC
H PVC szigetelő szalag készlet
E Juego de cintas aislantes PVC



No.	W (mm)	thickness / grubość (mm)	L (m)	pcs. packing	
75012	15	0.13	10	10	50
75028	19	0.13	20	10	25

PL Taśma ostrzegawcza
GB Warning tape
D Warnband, kleband
RUS Лента сигнальная

CZ Lepící páska výstražná
RO Bandă adezivă avertizare
H Figyelmeztető ragasztó szalag
E Cinta adhesiva de advertencia

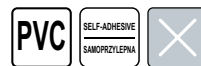

No.	W (mm)	L (m)	
75230	48	33	24

PL Taśma aluminiowa
GB Aluminium tape
D Aluminiumband
RUS Алюминиевая клейкая лента

CZ Hliníková páska
RO Bandă aluminiu
H Alumínium szalag
E Cinta de aluminiu



No.	W (mm)	L (m)	
75140	48	10	36
75141	48	50	24

PL Taśma PCV
GB PVC Tape
D PVC Band
RUS Изолента цветная

CZ Páska PVC
RO Banda izolatoare PVC
H PVC Szalag
E Cinta PVC



No.	W (mm)	thickness / grubość (mm)	L (m)	pcs. packing	
75060	19	0.13	3	6	10/100

PL Taśma PCV do użytku zewnętrznego
GB PVC tape
D PVC Band
RUS Лента ПВХ для внешних работ

CZ Páska PVC
RO Bandă PVC
H Kétoldalas PVC
E Cinta PVC



No.	W (mm)	L (m)	
75031	48	33	50

PL Taśma samowulkanizująca
GB Self-vulcanization tape
D Selbstvulkanisierendes Band
RUS Самовулканизирующая лента

CZ Páska samovulkanizační
RO Banda autovulcanizanta
H Ónvulkanizáló szalag
E Cinta autovulcanizadora



No.	W (mm)	thickness / grubość (mm)	L (m)	
75035	19	0.8	10	60
75036	25	0.8	5	60

PL Sznurek murarski
GB Builders line
D Maurerschnur
RUS Шнур каменщика

CZ Šňůra zednická
RO Sfoară pt. zidari
H Kőműves zsinór
E Cuerda de albañil



No.	L (m)	colour / kolor	
17488	50		60
17489	100		60

PL Linka pleciona polipropylenowa
GB Polypropylene sennit line
D Geflochtenes Seil aus Polypropylen
RUS Канат полипропиленовый плетёный

CZ Lano pletené polypropylenové
RO Coarda împletită din polipropilena
H Polipropilén fonott kótél
E Cuerda trenzada de polipropileno



VOREL

No.	Ø (mm)	L (m)	
69502	4	400	4
69503	5	250	4
69504	6	250	4
69505	8	300	2
69506	10	200	2
69507	12	180	1
69508	14	110	1
69509	16	80	1
69510	18	70	1

PL Sznurek murarski
GB Builders line
D Maurerschnur
RUS Шнур каменщика

CZ Šňůra zednická
RO Sfoară pt. zidari
H Kőműves zsinór
E Cuerda de albañil

75 m

EASY
ROLL-ON
LÄTWE
ROZWIJANIE

PE LINE
LINKA PE

PUSHING INTO
SOFT EARTH
MOZLIWOSC WBIECIA
W MIĘKKA ZIEMIE



VOREL

No.	L (m)	
17495	75	12/48

PL Sznurek murarski
GB Builders line
D Maurerschnur
RUS Шнур - причалка

CZ Šňůra zednická
RO Sfoară pt. zidari
H Kőműves zsinór
E Cuerda de albañil

40 m



No.	L (m)	
17490	40	80

PL Sznurek murarski, polipropylenowy
GB Polypropylene bricklayer's string
D Maurerschnur aus Polypropylen
RUS Шнур каменщика

CZ Šňůra zednická polypropylenová
RO Șnur de zidărie din polietilena
H Kőműves zsinór, polipropilén
E Cordel de albañileria



VOREL

No.	Ø (mm)	L (m)	
17470	1.7	50	60/240
17471	1.7	100	30/120
17473	2.0	50	60/240
17474	2.0	100	30/120

PL Sznurek murarski polietylenowy
GB Polyethylene bricklayer's string
D Maurerschnur aus Polyäthylen
RUS Полиэтиленовый шнур каменщика

CZ Šňůra zednická polyetylenová
RO Șnur de zidărie din polietilena
H Kőműves zsinór, polietilén
E Cordel de albañileria de polietileno

PE



VOREL

No.	Ø (mm)	L (m)	
17480	1.7	50	60/240
17481	1.7	100	30/120
17483	2.0	50	60/240
17484	2.0	100	30/120

PL Linka pleciona polipropylenowa
GB Polypropylene sennit line
D Geflochtenes Seil aus Polypropylen
RUS Канат полипропилен

CZ Lano pletené polypropylenové
RO Coarda împletita din polipropilena
H Polipropilén fonott kötél
E Cuerda trenzada de polipropileno



No.	Ø (mm)	L (m)	
69521	4	20	50

PL Lina jutowa skręciana
GB String jute rope
D Verdrillt Seil aus Jute
RUS Канат джутовый

CZ Lano jutová kroucená
RO Cablu răsucit de iuta
H Juta sodrott kötél
E Cable de yute torcido



No.	Ø (mm)	L (m)	
69572	10	10	20

PL Nici lniane, dratwa
GB Flax thread, twine
D Leinenfaden, Pechfaden
RUS Нить (дратва) льняная

CZ Nítě lněné, dratev
RO Fire de in, fire
H Len cérna, fonál
E Hilo de lino, cabo de zapatero



No.	dkg	
69635	10	28
69637	25	18

PL Linka pleciona, elastyczna
GB Elastic sennit line
D Geflochtenes Seil, elastisch
RUS Канат плетеный эластичный

CZ Lano pletené elastické
RO Coarda împletita, elastica
H Fonott kötél, rugalmas
E Cuerda trenzada elástica

RUBBER CORE
GUMOWY RDZEN



No.	Ø (mm)	L (m)	
69550	6	150	1
69551	8	100	1
69552	10	100	1

PL Sznurek PP pleciony, uniwersalny
GB Universal PP sennit string
D PP-Schnur, geflochten, universell
RUS Шнур полипропиленовый

CZ Šňůra PP pletená univerzální
RO Șnur PP împletit, universal
H PP fonott kötél, univerzális
E Cordel trenzado universal PP



No.	Ø (mm)	L (m)	
69620	3	10	50
69621	3	20	40

PL Sznurek pakowy, jutowy
GB Packing jute string
D Packschnur, aus Jute
RUS Шнур джутовый

CZ Šňůra ucpávková jutová
RO Șnur de împachetat, de iuta
H Csomagkötöző spárga, juta
E Cordel de yute para embalaje



No.	dkg	
69630	5	112
69631	10	100

PL Lina igłowa
GB Needle rope
D Nadelseil
RUS Канат полипропиленовый, плетеный

CZ Lano s jádrem opletené
RO Cablu ac
H Tűfonatos kötél
E Cable acalabrotado



No.	Ø (mm)	L (m)	
69539	8	10	30
69540	8	20	20
69542	10	10	25
69543	10	20	15
69546	12	20	10

PL Sznurek PP do podwiązania wełny izolacyjnej
GB Spliced wire polypropylene string
D Polypropylen Emtegar
RUS Шнур полипропиленовый
CZ Provázek polypropylenový
RO Șnur din polipropilena
H Špagát polypropylénový
E Cuerda



No.	Ø (mm)	L (m)	
69608	2.5	200	100
69609	2.5	300	80
69610	2.5	450	50
69612	2.5	1000	24
69613	2.5	2000	12

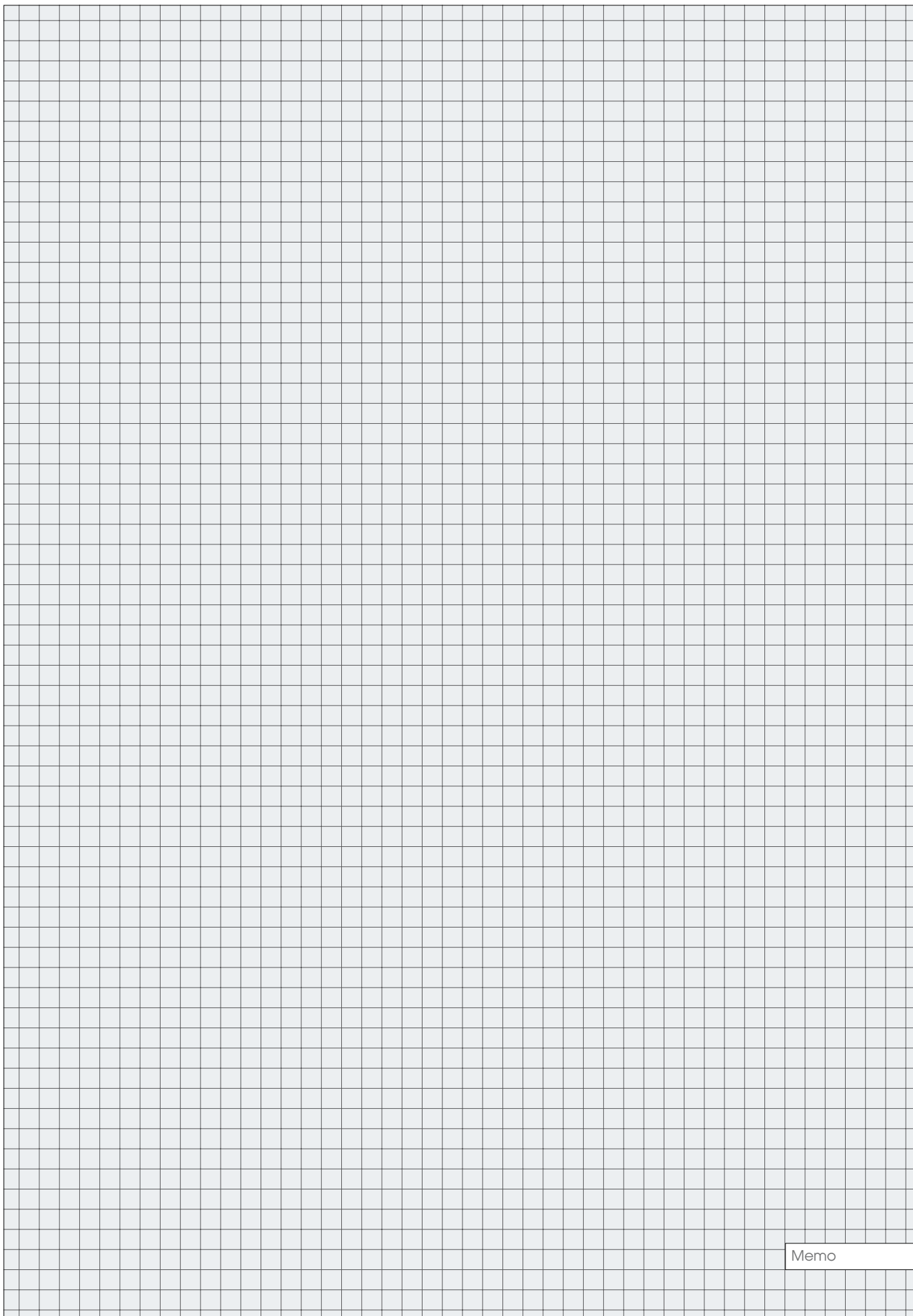

Memo

11

Plastering & bricklaying tools Narzędzia budowlane i malarskie



Floor laminate cutters Gilotyny do cięcia paneli podłogowych	
.....	136

Tile cutters & accessories Przyrządy do cięcia glazury i akcesoria	
.....	136-141

Tile cutters Przyrządy do glazury.....	136
--------------------------------------------------	-----

Tile cutting pliers Szczypce do glazury.....	137
--------------------------------------------------------	-----

Grout removers & finishers Skrobaki i szpachelki do fug.....	138
----------------------------------------------------------------------------	-----

Accessories for tiles Akcesoria do glazury.....	138
-----------------------------------------------------------	-----

Burners & soldering tools Palniki i lutownice	
.....	141-142

Gas burners & accessories Palniki gazowe i akcesoria	
.....	142-144

Ladders Drabiny	
.....	144-145

Masonry tools Narzędzia budowlane	
.....	145-163

Floats Pace.....	145
----------------------------	-----

Trowels Kielnie.....	147
--------------------------------	-----

Tools for areated blocks Narzędzia do betonu komórkowego.....	147
-------------------------------------------------------------------------	-----

Tools for drywalls Narzędzia do płyt gipsowo-kartonowych.....	148
-------------------------------------------------------------------------	-----

Scrapers Szpachelki.....	149
------------------------------------	-----

Painting scrapers Skrobaki malarskie.....	150
-----------------------------------------------------	-----

Mason's pans Czerpaki murarskie.....	151
------------------------------------------------	-----

Building strainers Sita budowlane.....	151
--------------------------------------------------	-----

Paint mixers & grout mixers Mieszadła do farb i do zaprawy.....	151
-------------------------------------------------------------------------------	-----

Paint rollers & accessories Wałki do malowania i akcesoria.....	153
-------------------------------------------------------------------------------	-----

Paint brushes Pędzle malarskie.....	155
-----------------------------------------------	-----

Multipurpose trays Podstawki gospodarcze.....	157
---------------------------------------------------------	-----

Painting sheets Folie malarskie.....	157
------------------------------------------------	-----

Tapes Taśmy.....	157
----------------------------	-----

Plastic buckets & tubs Wiadra i kastry budowlane.....	159
---------------------------------------------------------------------	-----

Suction lifters Uchwyty do szyb.....	160
------------------------------------------------	-----

Hooks „Juco” Haki budowlane „Juco”.....	161
---------------------------------------------------	-----

Carpenter's pencils & accessories Ołówki stolarskie i akcesoria.....	161
------------------------------------------------------------------------------------	-----

Benders Giętarek.....	161
---------------------------------	-----

Paving tools Narzędzia brukarskie.....	161
--------------------------------------------------	-----

PL Gilotyňa do cięcia paneli
GB Floor laminate cutter
D Laminat-Schneider
RUS Резак для ламината

CZ Nužky na laminatove plovoucí podlahy
RO Aparat de taiat parchet laminat
H Laminat padlo vagogelp
E Guillotina cortapaneles



VOREL

No.	mm	Ø (mm)	Cube
28880			2

PL Przyrząd do cięcia glazury
GB Tile cutting machine
D Fliesenschneidemaschine
RUS Плиткорез

CZ Přístroj na řezání glazury
RO Aparat de taiat faianta
H Csempevágó
E Cortadora de gres



VOREL

No.	mm	Ø (mm)	Cube
00320	450	19	1

PL Przyrząd do cięcia glazury
GB Tile cutting machine
D Fliesenschneidemaschine
RUS Плиткорез

CZ Přístroj na řezání glazury
RO Aparat de taiat faianta
H Csempevágó
E Cortadora de gres

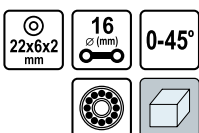

VOREL

No.	mm	Ø (mm)	Cube
00510	500	16	1
00610	590	16	1

PL Przyrząd do cięcia glazury
GB Tile cutting machine
D Fliesenschneidemaschine
RUS Плиткорез

CZ Přístroj na řezání glazury
RO Aparat de taiat faianta
H Csempevágó
E Cortadora de gres

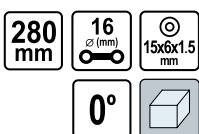

No.	mm	Ø (mm)	Cube
02300	280	16	6

PL Przyrząd do cięcia glazury
GB Tile cutting machine
D Fliesenschneidemaschine
RUS Плиткорез

CZ Přístroj na řezání glazury
RO Aparat de taiat faianta
H Csempevágó
E Cortadora de gres



VOREL

No.	mm	Ø (mm)	Cube
00300	600	19	1

PL Przyrząd do cięcia glazury
GB Tile cutting machine
D Fliesenschneidemaschine
RUS Плиткорез

CZ Přístroj na řezání glazury
RO Aparat de taiat faianta
H Csempevágó
E Cortadora de gres

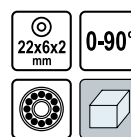

VOREL

No.	mm	Ø (mm)	Cube
00600	580	20	1

PL Przyrząd do cięcia glazury
GB Tile cutting machine
D Fliesenschneidemaschine
RUS Плиткорез

CZ Přístroj na řezání glazury
RO Aparat de taiat faianta
H Csempevágó
E Cortadora de gres

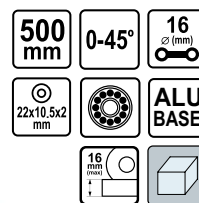

VOREL

No.	mm	Ø (mm)	Cube
00703	500	16	1

PL Przyrząd do cięcia glazury
GB Tile cutting machine
D Fliesenschneidemaschine
RUS Плиткорез

CZ Přístroj na řezání glazury
RO Aparat de taiat faianta
H Csempevágó
E Cortadora de gres

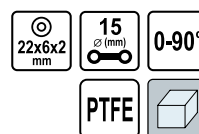

VOREL

No.	mm	Ø (mm)	Cube
01060	600	15	1

PL Przyrząd do cięcia glazury
GB Tile cutting machine
D Fliesenschneidemaschine
RUS Плиткорез

CZ Přístroj na řezání glazury
RO Aparat de taiat faianța
H Csempévágó
E Cortadora de gres

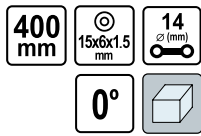

No.	mm	Ø (mm)	☐
02400	400	14	6

PL Kółko tnące wymienne
GB Tile cutting wheel
D Schneidrad
RUS Запасной ролик для плиткореза

CZ Výměnné kolečko
RO Cutiț rolă
H Cseregörgő csavarral
E Recambio de cuchillo redondo



No.	mm	for / dla	☐
03221	22x10.5x2	00703	50/200

PL Szczypce do cięcia i lamania glazury
GB Tile cutting pliers
D Glasurzange
RUS Кусачки для плитки

CZ Kleště do glazury
RO Clește rupt faianța
H Csempéfogó
E Tenazas para azulejos

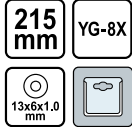

No.	L (mm)	☐
04001	215	50

PL Szczypce do lamania glazury
GB Tile cutting nipper
D Glasurzange
RUS Кусачки для плитки

CZ Kleště do glazury
RO Clește drept pt. glazură
H Egyenes csempéharapófogó
E Tenazas para azulejos recto



No.	L (mm)	☐
04022	200	6/60

PL Kółko wymienne ze śrubą
GB Tile cutting wheel
D Schneidrad mit Schraube
RUS Запасной ролик для плиткореза

CZ Výměnné kolečko se šroubem
RO Cutiț rola
H Cseregörgő csavarral
E Recambio de cuchillo redondo



No.	mm	for / dla	☐
03150	15x6x1.5	02300; 02400	50/200
03160	16x6x3	00300; 00320	50/200
03220	22x6x2	00510; 00600; 00610; 01060	50/200

PL Szczypce do glazury
GB Tile cutting pliers
D Glasurzange
RUS Кусачки для плитки

CZ Kleště do glazury
RO Clește rupt faianța
H Csempéfogó
E Tenazas para azulejos



No.	L (mm)	mm	☐
04000	200	15	10/60

PL Szczypce do cięcia glazury
GB Tile cutting pliers
D Glasurzange
RUS Кусачки для плитки

CZ Kleště do glazury
RO Clește rupt faianța
H Csempéfogó
E Tenazas para azulejos



No.	L (mm)	☐
04020	200	6/36

PL Szczypce do glazury
GB Tile cutting nipper
D Glasurzange
RUS Клещи для плитки твердосплавные

CZ Kleště do glazury jednoduché
RO Clește drept pt. glazură
H Egyenes csempéharapófogó
E Tenazas para azulejos recto



No.	L (mm)	☐
04200	200	12/60

PL Obcęgi do glazury wygięte
GB Tile cutting nipper
D Glasurzange
RUS Клещи для плитки твердосплавные

CZ Kleště do glazury ohnuté
RO Clește curbă pt. glazură
H Hajlított csempe harapófógó
E Tenazas para azulecos curvo



VOREL

No.	L (mm)	
04210	200	12/60

PL Skrobak do fug
GB Grout remover
D Fugenreiniger
RUS Скребок для швов плитки

CZ Škrabák na spáry
RO Spaclu pt. rosturi
H Fugakihúzó
E Rascador para juntas



VOREL

No.		
04410		40/400

PL Szpachelka do fug
GB Grout finisher
D Fugenreiniger
RUS Шпатель для затирки межплиточных швов

CZ Šušev skrěpers
RO Răzuitoare pt. rosturi
H Csempelező
E Rascador para juntas



VOREL

No.		
04410		450

PL Laser glazurniczy
GB Tile laser
D Fliesenlaser
RUS Уровень лазерный для укладки плитки

CZ Laserové vodováha
RO Nivelă cu laser pt. faianță și gresie
H Fűrészlaser
E Laser de baldosas de cuadrado

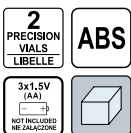

VOREL

No.	vials / libelle	
16030	2	20

PL Młotek glazurniczy z widziwym rysikiem
GB Tile hammer
D Fliesenhammer
RUS Молоток для облицовочной плитки, твердосплавный

CZ Kládívko na dlaždice
RO Ciocan pt. placi ceramice
H Csempézökalapács
E Martillo para azulejos



VOREL

No.	mm	
04131	12x12	16/96

PL Skrobak do fug
GB Grout remover
D Fugenreiniger
RUS Скребок для швов кладки

CZ Škrabák na spáry
RO Răzuitoare pt. rosturi
H Fugakihúzó
E Rascador para juntas



VOREL

No.		
04406		40/160

PL Skrobak do fug
GB Grout remover
D Fugenreiniger
RUS Скребок для швов плитки

CZ Škrabák na spáry
RO Spaclu pt. rosturi
H Fugakihúzó
E Rascador para juntas



VOREL

No.	mm	
04405	50x2	12/60

PL Piłka z brzeszczotem wolframowym
GB Tile saw
D Handsäge mit Wolfram-Sägedraht
RUS Пилка с карбид-вольфрамовым напылением

CZ Pílka na obklady a dlaždice
RO Fierăstrău pt. placi ceramice
H Fűrész csempéhez, kerámiahöz
E Sierra hilo carburo tungsteno



VOREL

No.	size / rozmiar	
27540	6" (150 mm)	5/60

- PL Wycinarka do otworów w glazurze
 GB Circular tile cutter
 D Fliesenbohrzeug
 RUS Резак по плитке
 CZ Výšeč otvorů v glazuře
 RO Cutit rotativ taiat faianta
 H Lyukkivágó csempéhez
 E Ruleta de corte para azulejos



No.	Ø (mm)	
03900	20-90	80/160

- PL Wycinarka do otworów w glazurze
 GB Circular tile cutter
 D Fliesenlochbohrer mit Handschutz
 RUS Резак по плитке „Балеринка” с защитной решеткой
- CZ Výšeč otvorů v glazuře
 RO Cutit rotativ taiat faianta
 H Lyukkivágó csempéhez
 E Ruleta de corte para azulejos



No.	Ø (mm)	
03940	20-94	24

- PL Rysik do cięcia glazury
 GB Hand tile cutter and breaker
 D Fliesengriffel
 RUS Резак для плитки
- CZ Rýsovací jehla na řezání glazury
 RO Cutit taiat / rupt faianta
 H Karttű csempévágáshoz
 E Cortador de azulejos



No.	L (mm)	
04050	130	50/400

- PL Przyrząd do poziomowania płytek
 GB Tile leveling set
 D Schlagschnurgerät
 RUS Уровень для укладки кафеля
- CZ Přístroj pro regulaci úrovně dlaždiček
 RO Fir pt. trasat
 H Padlólapszintező eszköz
 E Nivelador de cuerda para azulejos

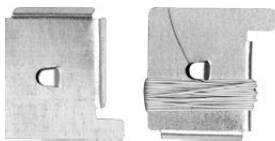

No.		
04500		60

- PL Wycinarka do otworów w glazurze
 GB Circular tile cutter
 D Fliesenbohrzeug
 RUS Резак по плитке
 CZ Výšeč otvorů v glazuře
 RO Cutit rotativ taiat faianta
 H Lyukkivágó csempéhez
 E Ruleta de corte para azulejos



No.	Ø (mm)	
03920	30-80	10/100

- PL Ostrze zapasowe do wycinarki 03940
 GB Spare blades for 03940
 D Schneide für 03940
 RUS Запасные элементы для резака 03940
- CZ Náhradní soustava na vystřihovačku H03940
 RO Lame rezerva pt. 03940
 H Tartalékkészlet a 03940 kivágóhoz
 E Juego de recambios para ruleta 03940



No.	for / dla	
03950	03940	20/200

- PL Rysik do cięcia i lamania glazury
 GB TC tile cutter and breaker
 D Fliesengriffel und Brecher
 RUS Плиткорез-карандаш с отламывателем
- CZ Rýsovací jehla na řezání a lámání glazury
 RO Cutit taiat / rupt faianta
 H Karttű csempévágáshoz és töréshez
 E Cortador y rompedor de azulejos



No.	L (mm)	
04100	200	50/100

- PL Maskownica uniwersalna
 GB Magnetic lock
 D Universal verdeckung mit Magnet
 RUS Замок магнитный для кафеля
- CZ Maskovací rám univerzální do glazury
 RO Opritor magnetic
 H Univerzális maszkoló csempéhez
 E Cierre magnetico universal



No.		
04510		40

PL Gąbka glazuryczna
GB Glazing sponge
D Fliesenschwamm
RUS Губка для затирки плитки

CZ Houbka na spárování obkladů
RO Burete pt. plăci ceramice
H Csempézó szivacs
E Esponja para esmaltar



No.	mm	
04540	165x100x60	74

PL Gąbka glazuryczna dwuwarstwowa
GB Double glazing sponge
D Doppelter Fliesenschwamm
RUS Губка для затирки плитки

CZ Houbka na spárování obkladů dvoustranná
RO Burete pt. plăci ceramice dublu
H Dupla csempézó szivacs
E Esponja para esmaltar doble



No.	mm	
04544	165x100x80	18

PL System poziomowania płytek
GB Tile leveling system
D Fliesen-Ausgleichssystem
RUS Система выравнивания плитки-зажим СВП
CZ Dlaždice nivelační systém
RO Sistemul de nivelare Placi
H Csempé szintező rendszer
E Sistema de nivelación del azulejo

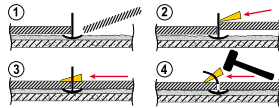

30x30	33x33	40x40	45x45	50x50	60x60	80x80	60x30	100x50	120x60
42	36	20	28	24	10	10	22	16	10

number of clips and wedges for various dimensions tiles per 1m² / Ilość klinów na 1m² w zależności od rozmiaru płytki:



No.	pcs	
04690	100	15

PL System poziomowania płytek
GB Tile leveling system
D Fliesen-Ausgleichssystem
RUS Система выравнивания плитки-зажим СВП
CZ Dlaždice nivelační systém
RO Sistemul de nivelare Placi
H Csempé szintező rendszer
E Sistema de nivelación del azulejo



No.	pcs	
04692	300+100	1

PL Gąbka glazuryczna hydrochlonna
GB Hygroscopic glazing sponge
D Wasserabsaugender Fliesenschwamm
RUS Губка для затирки плитки

CZ Houbka na spárování obkladů nasáková
RO Burete pt. plăci ceramice hidroabsorbant
H Nedvszívó csempézó szivacs
E Esponja para esmaltar higroscópica



No.	mm	
04542	170x110x60	56

PL Gąbka glazuryczna gumowa
GB Rubber glazing sponge
D Gummi-Fliesenschwamm
RUS Губка для затирки плитки

CZ Houbka na spárování obkladů gumová
RO Burete pt. plăci ceramice de cauciuc
H Gumi csempézó szivacs
E Esponja para esmaltar de goma

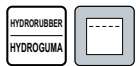

No.	mm	
04546	150x100x50	10

PL System poziomowania płytek
GB Tile leveling system
D Fliesen-Ausgleichssystem
RUS Система выравнивания плитки-зажим СВП
CZ Dlaždice nivelační systém
RO Sistemul de nivelare Placi
H Csempé szintező rendszer
E Sistema de nivelación del azulejo

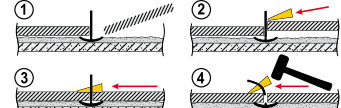
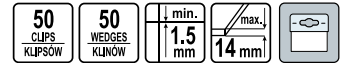

30x30	33x33	40x40	45x45	50x50	60x60	80x80	60x30	100x50	120x60
42	36	20	28	24	10	10	22	16	10

number of clips and wedges for various dimensions tiles per 1m² / Ilość klinów na 1m² w zależności od rozmiaru płytki:



No.	pcs	
04691	50+50	15

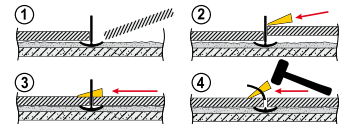

30x30	33x33	40x40	45x45	50x50	60x60	80x80	60x30	100x50	120x60
42	36	20	28	24	10	10	22	16	10

number of clips and wedges for various dimensions tiles per 1m² / Ilość klinów na 1m² w zależności od rozmiaru płytki:

PL Klíny do glazury
GB Wedges for wall and floor tiles
D Keile für Wand und Bodenfliesen
RUS Клинья для плитки

CZ Klíny do glazury
RO Distanțiere faianța
H Ék csempéhez
E Cuñas para juntas de azulejos



No.	mm	pcs packing	box
04700	23x4	100	100
04710	37x7	50	100

PL Klamry do paneli ściennych
GB Panel clamps
D Klammern für Paneele
RUS Крепеж для панелей

CZ Přichytky do panelů
RO Cleme (bride) pt. panouri
H Kapcsok c panelekhez
E Abrazaderas para paneles de paredes

100
PCS



No.	type	pcs packing	box
04720	C-3	100	50
04721	C-1	100	50

PL Gazowa lampa lutownicza
GB Gas soldering lamp
D Gaslötlampe
RUS Лампа паяльная газовая с пьезоподжигом

CZ Plynová pájecí lampa
RO Lampă de lipit pe gaz
H Gázos forrasztólámpa
E Lampa de gas para soldar

PIEZO ELECTRIC 1200°C max. 1.7 kW
123 g/h CARTRIDGE 190g BUTAN
METAL COVER METALOWY KORPUS



No.	kW	box
73403	1.7	12

PL Krzyżki dystansowe
GB Cross shape tile spacers
D Fliesenkreuze
RUS Крестики для плитки

CZ Distanční křížky
RO Distanțiere în cruce
H Hézagoló kereszt
E Crucetas para juntas



No.	mm	pcs packing	box
04600	1.5	200	100
04610	2.0	200	100
04620	2.5	200	100
04630	3.0	150	100
04640	4.0	100	100
04650	5.0	100	100
04660	6.0	75	100
04668	8.0	30	100
04670	10.0	30	100

PL Gazowa lampa lutownicza
GB Gas soldering lamp
D Gaslötlampe
RUS Газовая паяльная лампа

CZ Plynová pájecí lampa
RO Lampă de lipit pe gaz
H Gázos forrasztólámpa
E Lampa de gas para soldar

1200°C max. 1.7 kW 123 g/h
CARTRIDGE 190g BUTAN COMPOSITE BODY PLASTIKOWY KORPUS



No.	kW	box
73400	1.7	12

PL Palnik gazowy
GB Gas blow torch
D Lötbrenner
RUS Газовая роленка

CZ Plynový hořák
RO Arzator pe gaz
H Gázégő
E Soplete de gas

0.22 kW PIEZO GAS GAZ BUTANE lighter gas BUTAN (gas do zapalniczki)
10 g CAPACITY POJEMNOŚĆ 30 min LOCK BLOKADA CHILD PROTECTION ZABEZPIECZENIE PRZED DZIECIAMI
METAL COVER METALOWY KORPUS

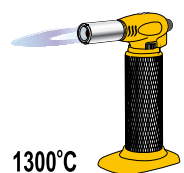

No.	kW	box
73420	0.22	10/60

- PL Lutownica gazowa 3 w 1
 GB Soldering tool 3 in 1
 D Gaslötkolben 3 in 1
 RUS Газовый паяльник 3-в-1
- CZ Plynova pajka 3 in 1
 RO Ciocan de lipit cu gaz 3 in 1
 H Gaz-forrasztópaka 3 in 1
 E Soldador de gas 3 in 1

15 ml
 25-80 W
 60 min

BUTANE lighter gas
 BUTAN gaz do zapalniczki

GAS
 GAZ

PROPANE-BUTANE lighter gas
 PROPAN-BUTAN gaz do zapalniczki



SOLDERING
 LUTOWANIE 450°C

TORCH
 PALNIK 1300°C

HOT SHRINKING
 OPALANIE 600°C



No.	W	
73410	25 - 80	12/48

- PL Palnik gazowy
 GB Gas blow torch
 D Lötbrenner
 RUS Газовая горелка
- CZ Plynový hořák
 RO Arzator pe gaz
 H Gázégő
 E Soplete de gas

PIEZO
 1.3 kW

1300 °C
 GAS
 GAZ

BUTANE
 BUTAN



No.	kW	
73413	1.3	10/60

- PL Dysza do lutowania płomień punktowy
 GB Point nozzle
 D Düse zum Löten, Punktflamme
 RUS Сопло паяльника
- CZ Dýza na letování, bodový plamen
 RO Duză pt. lipit, flacăără punct
 H Forrasztó égő, szúró láng
 E Tobera para soldadura, llama de punta

17 mm



No.	size / rozmiar (mm)	
73330	17	50/250

- PL Palnik gazowy
 GB Gas blow torch
 D Lötbrenner
 RUS Газовая горелка
- CZ Plynový hořák
 RO Arzator pe gaz
 H Gázégő
 E Soplete de gas

PIEZO
 1.3 kW
 1300 °C

GAS
 GAZ

BUTANE
 BUTAN

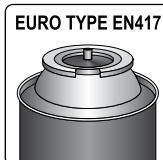

No.	kW	
73412	1.3	10/60

- PL Zestaw do lutowania z dyszami
 GB Plumbers torch set with burners
 D Lötsatz
 RUS Набор для пайки
 CZ Souprava k letování
 RO Set pt. lipit
 H Forrasztó készlet
 E Juego para soldadura

0.5 MPa (max.)
 x3
 17, 22, 40 mm

800-1200°C
 BUTAN

2m
 140 g/h
 2 kW
 360mm



No.	MPa (max)	kW	L (mm)	
73325	0.5	2	360	20

- PL Dysza do lutowania płomień płaski
 GB Flat nozzle
 D Düse zum Löten, flache Flamme
 RUS Сопло плоское
- CZ Dýza na letování, plochý plamen
 RO Duză pt. lipit, flacăără plată
 H Forrasztó égő, lapos láng
 E Tobera para soldadura, llama plana

40 mm



No.	size / rozmiar (mm)	
73331	40	50/250

- PL Dysza do lutowania promień otaczający
 GB Pipe nozzle
 D Düse zum Löten, Umgebungsflamme
 RUS Сопло паяльника, кольцевое

- CZ Dýza na letování, prstencový plamen
 RO Duză pt. lipit, flacără înconjurătoare
 H Forrasztó égő, körülölelő láng
 E Tobera para soldadura, llama envolvente



No.	size / rozmiar (mm)	
73332	22	50/250

- PL Palnik dekarski z dyszą i lancą
 GB Roof heating torch with burners
 D Dachdeckerbrenner
 RUS Кровельная горелка
 CZ Hořák pro pokrývače
 RO Arzător pt. acoperiș
 H Bádogos forrasztó készülék
 E Soplete de techado

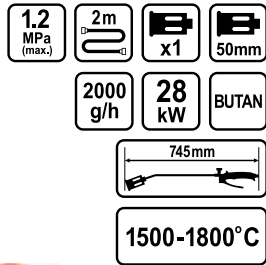

No.	MPa (max)	kW	L (mm)	
73341	1.2	28	745	20

- PL Palnik dekarski z dyszami i lancą
 GB Roof heating torch with burners
 D Dachdeckerbrenner
 RUS Кровельная горелка
 CZ Hořák pro pokrývače
 RO Arzător pt. acoperiș
 H Bádogos forrasztó készülék
 E Soplete de techado

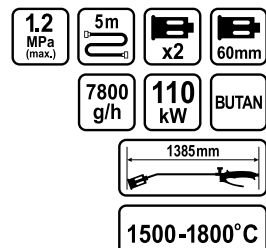

No.	MPa (max)	kW	L (mm)	
73343	1.2	110	1385	8

- PL Palnik dekarski z dyszami
 GB Roof heating torch with burners
 D Dachdeckerbrenner
 RUS Кровельная горелка
 CZ Hořák pro pokrývače
 RO Arzător pt. acoperiș
 H Bádogos forrasztó készülék
 E Soplete de techado

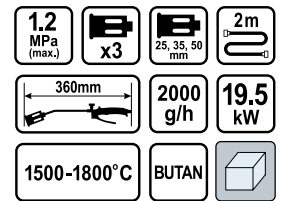

No.	MPa (max)	kW	L (mm)	
73340	1.2	19.5	360	10

- PL Palnik dekarski z dyszą i lancą
 GB Roof heating torch with burners
 D Dachdeckerbrenner
 RUS Кровельная горелка
 CZ Hořák pro pokrývače
 RO Arzător pt. acoperiș
 H Bádogos forrasztó készülék
 E Soplete de techado

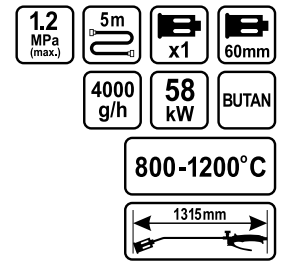

No.	MPa (max)	kW	L (mm)	
73342	1.2	58	1315	8

- PL Palnik dekarski z dyszami i lancą
 GB Roof heating torch with burners
 D Dachdeckerbrenner
 RUS Кровельная горелка
 CZ Hořák pro pokrývače
 RO Arzător pt. acoperiș
 H Bádogos forrasztó készülék
 E Soplete de techado

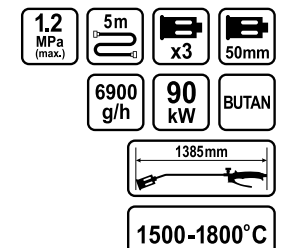

No.	MPa (max)	kW	L (mm)	
73344	1.2	90	1385	8

PL Dysza CZ Dýza
 GB Nozzle RO Duză
 D Düse H Fűvóka
 RUS Конло E Tobera



No.	Ø (mm)	Box
73350	25	25/50
73351	35	25/50
73352	50	25/50
73353	60	25/50

PL Drabina wielofunkcyjna
 GB Multifold ladder
 D Mehrzweckleiter
 RUS Многофункциональная стремянка

CZ Multifunkční žebřík
 RO Scară multifuncțională
 H Többcéllú létra
 E Escalera multipropósito

3.8 m max
 STEPS STOPNIE x13
 AL NYLON
 max 150 kg

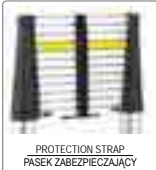

SAFE HOLDING SYSTEM
 ACCORDING TO HEIGHT
 SYSTEM ZABEZPIECZENIA
 W ZALEŻNOŚCI OD WYSOKOŚCI

3.8 m
 0.88 m



No.	Box
17701	1

PL Wąż przyłączeniowy do gazu CZ Hadice k připojení plynu
 GB Hose RO Furtun de conectare pt. gaz
 D Anschluss Schlauch für Gas H Csatlakozó gáztűelő
 RUS Шланг газоподводящий E Manguera de conexión de gas



No.	L (m)	Ø (mm)	Box
73360	2	8	40
73362	5	8	20

PL Drabina wielofunkcyjna
 GB Multifold ladder
 D Mehrzweckleiter
 RUS Лестница многофункциональная
 CZ Multifunkční žebřík
 RO Scară multifuncțională
 H Többcéllú létra
 E Escalera multipropósito

3.4 m max
 STEPS STOPNIE 4x3
 16 kg
 max 150 kg

1. ASSEMBLY OF THE LADDER
 2. SAFETY CHECKS
 3. SAFETY CHECKS
 4. SAFETY CHECKS
 5. SAFETY CHECKS
 6. SAFETY CHECKS
 7. SAFETY CHECKS
 8. SAFETY CHECKS
 9. SAFETY CHECKS
 10. SAFETY CHECKS
 11. SAFETY CHECKS
 12. SAFETY CHECKS
 13. SAFETY CHECKS
 14. SAFETY CHECKS
 15. SAFETY CHECKS
 16. SAFETY CHECKS
 17. SAFETY CHECKS
 18. SAFETY CHECKS
 19. SAFETY CHECKS
 20. SAFETY CHECKS
 21. SAFETY CHECKS
 22. SAFETY CHECKS
 23. SAFETY CHECKS
 24. SAFETY CHECKS
 25. SAFETY CHECKS
 26. SAFETY CHECKS
 27. SAFETY CHECKS
 28. SAFETY CHECKS
 29. SAFETY CHECKS
 30. SAFETY CHECKS
 31. SAFETY CHECKS
 32. SAFETY CHECKS
 33. SAFETY CHECKS
 34. SAFETY CHECKS
 35. SAFETY CHECKS
 36. SAFETY CHECKS
 37. SAFETY CHECKS
 38. SAFETY CHECKS
 39. SAFETY CHECKS
 40. SAFETY CHECKS
 41. SAFETY CHECKS
 42. SAFETY CHECKS
 43. SAFETY CHECKS
 44. SAFETY CHECKS
 45. SAFETY CHECKS
 46. SAFETY CHECKS
 47. SAFETY CHECKS
 48. SAFETY CHECKS
 49. SAFETY CHECKS
 50. SAFETY CHECKS
 51. SAFETY CHECKS
 52. SAFETY CHECKS
 53. SAFETY CHECKS
 54. SAFETY CHECKS
 55. SAFETY CHECKS
 56. SAFETY CHECKS
 57. SAFETY CHECKS
 58. SAFETY CHECKS
 59. SAFETY CHECKS
 60. SAFETY CHECKS
 61. SAFETY CHECKS
 62. SAFETY CHECKS
 63. SAFETY CHECKS
 64. SAFETY CHECKS
 65. SAFETY CHECKS
 66. SAFETY CHECKS
 67. SAFETY CHECKS
 68. SAFETY CHECKS
 69. SAFETY CHECKS
 70. SAFETY CHECKS
 71. SAFETY CHECKS
 72. SAFETY CHECKS
 73. SAFETY CHECKS
 74. SAFETY CHECKS
 75. SAFETY CHECKS
 76. SAFETY CHECKS
 77. SAFETY CHECKS
 78. SAFETY CHECKS
 79. SAFETY CHECKS
 80. SAFETY CHECKS
 81. SAFETY CHECKS
 82. SAFETY CHECKS
 83. SAFETY CHECKS
 84. SAFETY CHECKS
 85. SAFETY CHECKS
 86. SAFETY CHECKS
 87. SAFETY CHECKS
 88. SAFETY CHECKS
 89. SAFETY CHECKS
 90. SAFETY CHECKS
 91. SAFETY CHECKS
 92. SAFETY CHECKS
 93. SAFETY CHECKS
 94. SAFETY CHECKS
 95. SAFETY CHECKS
 96. SAFETY CHECKS
 97. SAFETY CHECKS
 98. SAFETY CHECKS
 99. SAFETY CHECKS
 100. SAFETY CHECKS



No.	Box
17704	1

- PL Podest do drabiny wielofunkcyjnej
 GB Multifunction ladder platform
 D Podest für die Multifunktionale Leiter
 RUS Подставки для стремянки
 CZ Plošina pro víceúčelový žebřík
 RO Platformă pt. scară multifuncțională
 H Palló a multifunkciós létrához
 E Descansillos para la escala multifuncional



No.	for / dla	□
17705	17704	5

- PL Paca styropianowa
 GB Polystyrene plastering trowel
 D Styropor-Reibebrett
 RUS Тёрка пенопластовая
- CZ Polystyrénové hladítko
 RO Gletiera poliuretan
 H Habszivacs simító
 E Llana de polietileno



No.	mm	□
06420	140x700	10
06430	140x1000	10

- PL Tarka do styropianu
 GB Steel plastering trowel
 D Reibebrett für Styropor
 RUS Тёрка стальная нержавеющая
- CZ Ohnutá špachtle nerezavějící
 RO Gletiera otel
 H Spatula hajlított, rozsdamentes
 E Espatula de acero inox curvo



No.	mm	□
06470	270x130	20
06472	350x160	15

- PL Paca tynkarska filc
 GB Plastering trowel
 D Filzgläter
 RUS Тёрка пластмассовая с войлочным покрытием
 CZ Umělohmotné hladítko omítkářské z filcem
 RO Gletiera PVC cu pasla
 H Műanyag simító vakoláshoz, filcel
 E Llana de plástico para enlucido con fieltro



No.	mm	□
06510	270x130	20

- PL Paca styropianowa
 GB Polystyrene plastering trowel
 D Styropor-Reibebrett
 RUS Тёрка пенопластовая
- CZ Polystyrénové hladítko
 RO Gletiera poliuretan
 H Habszivacs simító
 E Llana de polietileno



No.	mm	□
06400	130x270	10
06410	140x500	10
06440	170x320	10

- PL Paca styropianowa kątowna
 GB Polystyrene plastering trowel
 D Fummelbrett aus Kunststoff
 RUS Тёрка пенопластовая
- CZ Polystyrénové hladítko úhlové
 RO Gletiera poliuretan unghiulara
 H Habszivacs simító, derékszögű
 E Llana de polietileno en angulo



No.	mm	□
06401	80x340	10

- PL Paca tynkarska plastikowa
 GB Plastic plastering trowel
 D Glätkele
 RUS Гладилка пластиковая
- CZ Umělohmotné hladítko omítkářské
 RO Gletiera PVC
 H Műanyag simító vakoláshoz
 E Llana de plástico para enlucido



No.	mm	□
06500	270x130	24

- PL Paca tynkarska miękka guma
 GB Soft rubber plastering trowel
 D Gummireibebrett
 RUS Тёрка пластмассовая с резиновым покрытием
 CZ Umělohmotné hladítko omítkářské z měkkou gumou
 RO Gletiera PVC cu cauciuc
 H Műanyag simító vakoláshoz, lágy gumival
 E Llana de plástico para enlucido con goma suave



No.	mm	□
06520	270x130	30

- PL Paca tynkarska gęsta gąbka
 GB Plastering trowel
 D Schwambrett
 RUS Тёрка штукатурная с поролоновым покрытием (пластмассовая)
 CZ Umělohmotné hladítko omítkářské z hustou houbou
 RO Gletiera PVC cu burete dens
 H Műanyag simító vakoláshoz, tömör szivaccsal
 E Lana de plástico para enlucido con esponja densa



No.	mm	
06530	270x130	20

- PL Paca tynkarska metalowa nierdzewna
 GB Stainless steel plastering trowel
 D Schweizer Glätte
 RUS Гладилка нержавеющей гладкая
 CZ Hladitko omítkářské nerezavějící
 RO Gletiera inox
 H Rozsdamentes simító vakoláshoz
 E Lana para enlucido acero inox. llano



No.	mm	
06640	380x128	10
06660	480x128	10
06680	580x128	18

- PL Paca tynkarska metalowa nierdzewna
 GB Stainless steel plastering trowel
 D Glättekelle
 RUS Гладилка нержавеющая с пластмассовой ручкой
 CZ Hladitko omítkářské nerezavějící
 RO Gletiera inox maner plastic
 H Rozsdamentes simító vakoláshoz
 E Lana para enlucido acero inox. llano



No.	mm	
06700	270x125	24

- PL Paca tynkarska metalowa nierdzewna
 GB Stainless steel plastering trowel
 D Glättekelle gezahnt
 RUS Гладилка нержавеющей зубчатая
 CZ Hladitko omítkářské nerezavějící
 RO Gletiera inox
 H Rozsdamentes simító vakoláshoz
 E Lana para enlucido acero inox. llano



No.	mm	teeth / zęby (mm)	
06740	270x125	4x4	24
06760	270x125	6x6	24
06780	270x125	8x8	24
06781	270x125	10x10	24

- PL Paca tynkarska rzadka gąbka
 GB Plastering trowel
 D Schwambrett
 RUS Тёрка штукатурная с поролоновым покрытием (пластмассовая)
 CZ Umělohmotné hladítko omítkářské z řídkou houbou
 RO Gletiera PVC cu burete rar
 H Műanyag simító vakoláshoz, lágy szivaccsal
 E Lana de plástico para enlucido con esponja poco densa



No.	mm	
06540	270x130	20

- PL Paca tynkarska metalowa nierdzewna
 GB Stainless steel plastering trowel
 D Schweizer Glätte gezahnt
 RUS Гладилка металлическая зубчатая
 CZ Hladitko omítkářské nerezavějící
 RO Gletiera inox
 H Rozsdamentes simító vakoláshoz
 E Lana para enlucido acero inox. llano



No.	mm	teeth / zęby (mm)	
06650	380x128	8x8	10
06670	480x128	8x8	10
06690	580x128	8x8	18

- PL Paca tynkarska metalowa nierdzewna, podstawa aluminium
 GB Stainless steel plastering trowel
 D Glättekelle
 RUS Гладилка стальная нержавеющая гладкая
 CZ Hladitko omítkářské nerezavějící
 RO Gletiera inox
 H Rozsdamentes simító vakoláshoz
 E Lana para enlucido acero inox. llano



No.	mm	
06701	270x130	24

- PL Paca miękka z gumą do fugowania
 GB Float with soft rubber
 D Weiches Reibebrett mit Gummi zum Verfugen
 RUS Тёрка для затирки швов
 CZ Hladitko měkké s gumou na spárování
 RO Pac moale cu cauciuc pt. cimentare
 H Fugázó simító puha gumival
 E Lana suave con goma para rejuntar



No.	mm	
06512	260x95	12

- PL** Paca plastikowa z gąbką nacinaną
GB Plastic float with incised sponge
D Reibebrett aus Kunststoff, mit aufgeschnittenem Schwamm
RUS Пластиковый шпатель с надрезной губкой
CZ Plastové hladítko s nařezanou houbou
RO Netezitoare din plastic cu burete tăiat
H Műanyag simító, szivaccsal
E Liana de plástico con esponja entallada

VOREL

No.	L (mm)	sponge thickness / grubość gąbki (mm)	
06532	270x130	30	20

- PL** Kielnia trójkątna
GB Brick trowel
D Spitzkelle
RUS Кельма треугольная
CZ Zednická lžice trojúhelníková
RO Mistrie triunghiulară
H Háromszög vakolókanál
E Paleta triangular

VOREL

No.	mm	
06340	180	50
06350	200	50
06360	220	50

- PL** Kielnia trapezowa nierdzewna
GB Stainless steel brick trowel
D Stukkaturkelle
RUS Кельма шпательная нержавеющая
CZ Lichoběžníková zednická lžice nerezavějící
RO Mistrie trapezoidală inoxidabilă
H Trapéz vakolókanál, rozsdamentes
E Paleta trapezoidal de acero inox.

VOREL

No.	mm	
06370	130	50
06380	180	30

- PL** Kielnia do betonu komórkowego
GB Trowel for areated blocks
D Kelle für Porenbeton
RUS Кельма для газобетона
CZ Zednická lžice na pórbeton
RO Mistrie pt. bca
H Habarcsterítő kanál sejtbetonhoz
E Allanadora para hormigón celular

VOREL

No.	mm	
05801	100	10
05802	115	10
05803	125	10
05804	200	10
05805	240	10
05806	300	10
05807	365	10

- PL** Paca plastikowa z hydrogumą
GB Plastic float with hydrorubber
D Reibebrett aus Kunststoff, mit Hydrogummi
RUS Терка шлифовальная с мягкой губчатой накладкой
CZ Plastové hladítko s pěnovou gumou
RO Netezitoare din plastic cu hidrocauciu
H Műanyag simító, durva szivaccsal
E Liana de plástico con hidrocaucho

VOREL

No.	L (mm)	rubber thickness / grubość gummy (mm)	
06537	270x130	9	20
06538	270x130	18	20

- PL** Kielnia trójkątna nierdzewna
GB Stainless steel brick trowel
D Spitzkelle
RUS Кельма треугольная нержавеющая
CZ Zednická lžice trojúhelníková nerezavějící
RO Mistrie triunghiulară inoxidabilă
H Háromszög vakolókanál, rozsdamentes
E Paleta triangular de acero inox.

VOREL

No.	mm	
06341	180	50
06351	200	30

- PL** Kielnia sztukatorska, podkowa
GB Stainless steel scraper
D Stukkateurspachtel
RUS Кельма штукатурная
CZ Ohnutá špachtle nerezavějící
RO Șpaclu indoit inoxidabil
H Spatula hajlított, rozsdamentes
E Espatula de acero inox curvo

VOREL

No.	mm	
06110	60x110	50
06120	80x120	50



- PL Wiertło do bloczków CZ Vrták do kvádrů
 GB Borer for aerated blocks RO Sfredel pt. bca
 D Bohrer für Porenbeton H Falfűró
 RUS Сверло по газобетону E Taladro para bloques



No.	mm	
05821	60	20
05822	80	20
05823	120	20

- PL Zdzierak wyrównujący z ząbkami
 GB Scraper with teeth for plaster and aerated blocks
 D Ausgleichbrett mit Zähnen
 RUS Скребок-рубанок для газобетона зубчатый
 CZ Vyrovňovací škrabák se zoubky
 RO Drișcă nivelare cu dinți
 H Fogas, kiegyenlítő dörzsölő
 E Raspador con dientes



No.	mm	
05831	80x400	10

- PL Rylec do betonu komórkowego CZ Drážkovač na pórobeton
 GB Grooving device for aerated concrete RO Dispozitiv canelat bca
 D Werkzeug für Porenbeton bohrung H Horonymaró sejtbetonhoz
 RUS Штроборез по газобетону E Cincel para hormigón celular



No.		
05850		24

- PL Pila do gazobetonu GB Saw for gas concrete
 D Gasbetonsäge
 RUS Пила по газобетону с твердосплавным зубом
 CZ Pila na plynobeton
 RO Fierastrau cu placute vidia pt. BCA
 H Fűrész gázbetonhoz
 E Sierra para gas hormigón



No.	L (mm)	teeth / zęby	
28000	600	33/33	5
28010	600	33/17	5

- PL Zdzierak wyrównujący GB Scraper for plaster and aerated blocks
 D Schaber Gipskartonplatten und belüftete Blöcke
 RUS Скребок-рубанок, зубчатый
 CZ Vyrovňovací škrabák
 RO Gletiera lem pt. tencuieli
 H Kiegyenlítő dörzsölő
 E Raspador



No.	mm	
05830	80x400	10

- PL Przymiar do cięcia pod kątem GB Template tool for aerated blocks cut
 D Werkzeug für Porenbeton schneiden
 RUS Угольник для резки газобетона
 CZ Pravitko k řezání pod úhlem
 RO Dispozitiv pt. taiat bca
 H Gérvágó tok
 E Calibre de comprobación para cortes angulares



No.		
05840		4

- PL Stalowa dźwignia do unoszenia płyt CZ Ocelový nožní zvedák na desky
 GB Steel drywall board lifter RO Dispozitiv ridicare placi rigips
 D Stahlhebel zum Anheben der Platten H Acél kar a lapok felemeléséhez
 RUS Ножной рычаг для подъема листовых материалов E Palanca de acero para la elevación de placas



No.		
04750		6/24

- PL Pila do gazobetonu GB Saw for gas concrete
 D Gasbetonsäge
 RUS Пила по газобетону с твердосплавным зубом
 CZ Pila na plynobeton
 RO Fierastrau cu placute vidia pt. beton
 H Fűrész gázbetonhoz
 E Sierra para gas hormigón



No.	L (mm)	teeth / zęby	
28011	600	15	6/12
28012	660	34	6/12

PL Szpachelka
GB Scraper
D Malerspachtel
RUS Шпатель

CZ Špachtle
RO Șpaclu
H Spatula
E Espatula



No.	mm	
06030	30	12/240
06040	40	12/240
06050	50	12/240
06060	60	12/240
06080	80	12/240
06100	100	12/240

PL Szpachelka kałowa wewnętrzna
GB Stainless steel scraper
D Kelle für Innenecken
RUS Кельма для внутренних углов

CZ Úhlová špachtle vnitřní
RO Șpaclu unghiular interior
H Belsőél kanál
E Paleta en angulo

80x60x60 mm



No.	mm	
06150	80x60x60	50

PL Szpachelki „japonki” nierdzewne
GB Stainless steel scraper set
D Aufstreichspachtel
RUS Набор шпателей нержавеющей стали тип „японский”
CZ Špachtle japonsky nerezavějící
RO Șpaclu japonez inox set
H Spatula rozsdamentes
E Espatulas „japonesas” de acero inox

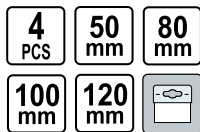

No.	mm	pcs	
06290	50; 80; 100; 120	4	12/120

PL Komplet szpachelek
GB Scraper set
D Malerspachtelsatz
RUS Набор шпателей

CZ Špachtle
RO Șpacluri
H Spatula
E Espatulas

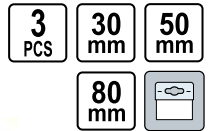

No.	mm	pcs	
06130	30; 50; 80	3	25/100

PL Szpachelka kałowa zewnętrzna
GB Stainless steel scraper
D Kelle für Aussenecken
RUS Кельма для наружных углов

CZ Úhlová špachtle vnější
RO Șpaclu unghiular exterior
H Külsóél kanál
E Paleta en angulo

80x60x60 mm



No.	mm	
06140	80x60x60	50

PL Szpachla malarska nierdzewna
GB Stainless steel putty knife
D Glasurzange
RUS Шпатель фасадный

CZ Malířská špachtle nerezavějící
RO Șpaclu de chituit, inox, maner plastic
H Rozsdamentes festőspatula
E Espatula de pintura, de acero inox



No.	mm	
06294	40	100
06295	60	80
06296	80	60
06297	100	50
06298	150	80
06301	200	60
06304	250	50
06307	350	25
06308	450	25
06309	600	10

- PL Szpachla nierdzewna CZ Špachtle nerezavějici
 GB Stainless steel putty knife RO Spaclu de chituit, inox, maner plastic, crestat
 D Kleberspachtel H Rozsdamentes spatula
 RUS Шпатель фасадный зубчатый E Espatula de acero inox.



No.	mm	teeth / zęby (mm)	
06299	150	6x6	80
06300	150	8x8	80
06302	200	6x6	60
06303	200	8x8	60
06305	250	6x6	50
06306	250	8x8	50

- PL Szpachelka nierdzewna CZ Špachtle
 GB Stainless steel scraper RO Spaclu
 D Rostfrei Spachtel H Spatula
 RUS Шпатель нержавеющей E Espatula de acero inox



No.	mm	
05901	30	6/72
05902	40	6/72
05903	50	6/72
05904	60	6/72
05905	80	6/72
05906	100	6/72

- PL Szpachelka nierdzewna wygięta CZ Špachtle
 GB Stainless steel scraper RO Spaclu
 D Rostfrei Spachtel H Spatula
 RUS Шпатель нержавеющей изогнутый E Espatula de acero inox curvo



No.	mm	
05921	30	6/72
05922	40	6/72
05923	50	6/72
05924	60	6/72
05925	80	6/72
05926	100	6/72

- PL Szpachla gumowa do fugowania CZ Pryžová špachtle na fugování
 GB Rubber grout spreader RO Spaclu cauciucat pt. rosturi
 D Gummispachtel H Fugázógumi
 RUS Шпатель резиновый для фуговки E Espátula de goma para rejuntar



No.	mm	
06310	150	30
06320	200	30
06330	250	30
06331	300	30

- PL Szpachelka nierdzewna CZ Špachtle
 GB Stainless steel scraper RO Spaclu
 D Rostfrei Spachtel H Spatula
 RUS Шпатель нержавеющей E Espatula de acero inox



No.	mm	
05911	30	6/72
05912	40	6/72
05913	50	6/72
05914	60	6/72
05915	80	6/72
05916	100	6/72

- PL Skrobak malarski CZ Škrabka malířská
 GB Painting scraper RO Răzuitor pt. zugrăvi
 D Malerabkratzer H Festékvakaró
 RUS Скребок для краски E Rascador de pintor
 со сменным лезвием



No.	blade / ostrze L (mm)	
06795	100	60

PL Skrobak malarski
GB Painting scraper
D Malerabkratzer
RUS Скребок для удаления краски

CZ Škrabka mališská
RO Răzuitor pt. zugrăvi
H Festékvakaró
E Rascador de pintor



No.	W (mm)	50
06797	115	50

PL Czerpak murarski
GB Mason's pan
D Gipspfänchen
RUS Ковш штукатурный

CZ Zednický koreček
RO Cancioc
H Kőműveskanál
E Achicador de albanil



No.	50
06335	50

PL Mieszadło do farbu
GB Paint mixer
D Farbmischer
RUS Мешалка для краски

CZ Michadlo na hmoty
RO Mixer popsea / var
H Keverő festékekhez
E Mezclador para pinturas



No.	mm	40/80
09060	60x400	40/80
09080	85x400	40/80
09090	100x600	30

PL Mieszadło do zapraw i klejów
GB Mixer for compound and glue
D Wenderührer
RUS Мешалка для клеевой массы и цемента

CZ Michadlo na malty a lepidla
RO Agitator pt. mortar și cleiuri
H Habarcs és ragasztó keverő
E Mezcladora para morteros y pegamentos



No.	mm	40
09010	110x510	40

PL Ostrze do skrobaka 06795
GB Spare blades for 06795
D Schneide für 06795
RUS Сменные лезвия для скребка 06795

CZ Ostří do škrabky
RO Taiș pt. răzuitor
H Festékvakaró-pengék
E Filo para rascador



No.	for / dla	pcs packing	10/100
06796	06795	5	10/100

PL Sito budowlane
GB Building strainer
D Bau Sieb
RUS Сито строительное
CZ Prohazovací síto stavební
RO Sita construcții
H Építőipari rosta
E Cedazo para construcción



No.	cm	size of eyelet / rozmiar oczka (mm)	30
34944	60x100	4	30
34945	60x100	6	30
34946	60x100	8	30
34947	60x100	10	30

PL Mieszadło do zapraw i klejów
GB Mixer for compound and glue
D Wenderührer
RUS Мешалка для клеевой массы и цемента

CZ Michadlo na malty a lepidla
RO Agitator pt. mortar și cleiuri
H Habarcs és ragasztó keverő
E Mezcladora para morteros y pegamentos



No.	mm	40
09005	65x410	40
09006	80x410	40

PL Mieszadło do gipsu i gładzi
GB Mixer for gypsum and coat
D Gips- und Wachsührer
RUS Мешалка для гипса

CZ Michadlo na sádru a stěrku
RO Agitator pt. ipsos și honuituri
H Gipsz és glett keverő
E Mezcladora para yeso



No.	mm	40
09015	85x400	40
09017	100x500	20

- PL Mieszadło do gipsu i gładzi
 GB Mixer for gypsum and coat
 D Gips- und Wachsührer
 RUS Мешалка для гипса
- CZ Michadlo na sádru a stěrku
 RO Agitator pt. ipsos și honuituri
 H Gipsz és glett keverő
 E Mezcladora para yeso



No.	mm	type	
09025	75x370	C-75	20

- PL Mieszadło do mas
 GB Mixer for compound
 D Rührer für Materialien auf Bitumenbasis
 RUS Мешалка для штукатурки
- CZ Michadlo na stavební hmoty
 RO Agitator pt. mase
 H Keverő masszához
 E Mezcladora para masas



No.	mm	type	
09048	75x400	C-75	20
09049	85x450	C-85	20
09050	100x500	C-100	20
09051	110x550	C-110	20

- PL Mieszadło do materiałów sypkich
 GB Mixer for loose materials
 D Mischer
 RUS Мешалка для гипса
- CZ Michadlo na sypké materiály
 RO Agitator pt. materiale vârsătoare
 H Keverő szóródó anyagokhoz
 E Mezcladora para materiales sueltos



No.	mm	
09028	80x400	35

- PL Mieszadło
 GB Mixer
 D Rondenührer
 RUS Мешалка для штукатурки
- CZ Michadlo
 RO Mixer
 H Keverő
 E Mezcladora



No.	mm	type	
09094	120x600	C-120	10

- PL Mieszadło do mas
 GB Mixer for compound
 D Rührer für Materialien auf Bitumenbasis
 RUS Мешалка для штукатурки
- CZ Michadlo na stavební hmoty
 RO Agitator pt. mase
 H Keverő masszához
 E Mezcladora para masas



No.	mm	
09044	80x400	25
09046	100x600	25

- PL Mieszadło do mas
 GB Mixer for compound
 D Rührer für Materialien auf Bitumenbasis
 RUS Мешалка для штукатурки
- CZ Michadlo na stavební hmoty
 RO Agitator pt. mase
 H Keverő masszához
 E Mezcladora para masas



No.	mm	
09054	80x400	25
09056	100x600	25

- PL Mieszadło do mas
 GB Mixer for compound
 D Mörtel Mischer
 RUS Мешалка для штукатурки
- CZ Michadlo na stavební hmoty
 RO Agitator pt. mase
 H Keverő masszához
 E Mezcladora para masas



No.	mm	
09036	60x400	60
09038	80x400	35
09040	100x600	30

- PL Mieszadło turbo z gwintem
 GB Turbo threaded stirrer
 D Turbomischer mit Gewinde
 RUS Мешалка с нарезкой
- CZ Michadlo turbo se závitem
 RO Dispozitiv de amestecat turbo cu filet
 H Menetes, turbó keverő
 E Turbo mezcladora con rosca



No.	mm	type	
09063	115x580	M14	10
09065	135x580	M14	10

- PL Walek do odpowietrzania
- GB Deaeration roller
- D Entlüftungsrolle
- RUS Валик азрационный
- CZ Váleček na odvzdušňování
- RO Rola pt. modelare sapa
- H Levegőkinyomó henger
- E Rodillo para hacer el vacío



No.	mm	📦
06450	75x230	15
06452	110x230	10

- PL Walek malarski Syntex
- GB Paint roller Syntex
- D Malerroller Syntex
- RUS Валик в сборе полиакрил
- CZ Malířský váleček
- RO Trafalet Syntex
- H Festöhenger
- E Rodilli de pintura



No.	roller width / szerokość wałka W (mm)	cover pile height / wysokość poszycia A (mm)	hole diameter / średnica otworu na uchwyt Ø (mm)	📦
09307	180	20	6	55
09308	250	20	6	50

- PL Walek malarski Vestan
- GB Paint roller Vestan
- D Malerroller
- RUS Валик в сборе, полиакрил
- CZ Malířský váleček
- RO Trafalet lana artificiala
- H Festöhenger
- E Rodilli de pintura

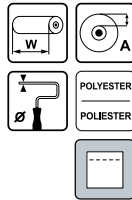

No.	roller width / szerokość wałka W (mm)	cover pile height / wysokość poszycia A (mm)	hole diameter / średnica otworu na uchwyt Ø (mm)	📦
09345	180	15	6	55
09346	250	15	6	50

- PL Walek malarski Moltopren
- GB Paint roller Moltopren
- D Malerroller Moltopren
- RUS Валик в сборе поролон
- CZ Malířský váleček
- RO Trafalet Burete cu tija plastic
- H Festöhenger
- E Rodilli de pintura

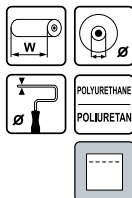

No.	roller width / szerokość wałka W (mm)	roller diameter / średnica wałka (mm)	hole diameter / średnica otworu na uchwyt Ø (mm)	📦
09370	50	35	6	70

- PL Walek do odpowietrzania
- GB Deaeration roller
- D Entlüftungsrolle
- RUS Валик азрационный
- CZ Váleček na odvzdušňování
- RO Rola pt. modelare sapa
- H Levegőkinyomó henger
- E Rodillo para hacer el vacío



No.	mm	📦
06453	110x500	6

- PL Walek malarski Girpaint
- GB Paint roller Girpaint
- D Malerroller Girpaint
- RUS Валик полиакрил в сборе
- CZ Malířský váleček Girpaint
- RO Trafalet cu fir galben
- H Festöhenger Girpaint
- E Rodilli de pintura Girpaint

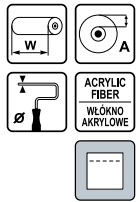

No.	roller width / szerokość wałka W (mm)	cover pile height / wysokość poszycia A (mm)	hole diameter / średnica otworu na uchwyt Ø (mm)	📦
09334	100	9	6	40
09336	180	18	6	60

- PL Walek malarski Flok
- GB Paint roller Flok
- D Malerroller Flok
- RUS Валик в сборе мольтопреп
- CZ Malířský váleček
- RO Trafalet burete fin
- H Festöhenger
- E Rodilli de pintura

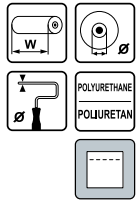

No.	roller width / szerokość wałka W (mm)	roller diameter / średnica wałka (mm)	hole diameter / średnica otworu na uchwyt Ø (mm)	📦
09359	150	50	6	50

- PL Walek malarski Moltopren
- GB Paint roller Moltopren
- D Malerroller Moltopren
- RUS Валик в сборе поролон
- CZ Malířský váleček
- RO Trafalet Burete cu tija plastic
- H Festöhenger
- E Rodilli de pintura

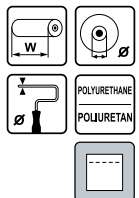

No.	roller width / szerokość wałka W (mm)	roller diameter / średnica wałka (mm)	hole diameter / średnica otworu na uchwyt Ø (mm)	📦
09371	70	35	6	80
09372	100	35	6	70
09373	150	50	6	50

- PL Zapas do walka Multicolor
 GB Paint roller refill Multicolor
 D Maler-Ersatzwalzen Multicolor
 RUS Шубка полиамидовая для валика
- CZ Náhradní váleček Multicolor
 RO Rezerva trafalet fir Multicolor
 H Csere festőhenger Multicolor
 E Llana de polietileno Multicolor



No.	roller width / szerokość walka W (mm)	cover pile height / wysokość poszycia A (mm)	hole diameter / średnica otworu na uchwyt Ø (mm)	☐
09302	180	15	6	40
09303	250	15	8	25

- PL Zapas do walka
 GB Paint roller refill
 D Maler-Ersatzwalzen
 RUS Шубка нейлоновая для валика
- CZ Náhradní váleček
 RO Rezerva trafalet acril rosu
 H Csere festőhenger
 E Repuesto para el cilindro



No.	roller width / szerokość walka W (mm)	cover pile height / wysokość poszycia A (mm)	hole diameter / średnica otworu na uchwyt Ø (mm)	☐
09331	180	6	6	10/50
09332	250	6	8	10/40

- PL Zapas do walka Flok
 GB Paint roller refill Flok
 D Maler-Ersatzwalzen Flok
 RUS Шубка мольтопреп
- CZ Náhradní váleček Flok
 RO Rezerva trafalet burete fir
 H Csere festőhenger Flok
 E Esponja de recambio

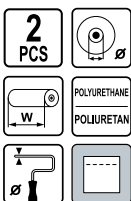

No.	roller width / szerokość walka W (mm)	roller diameter / średnica walka (mm)	hole diameter / średnica otworu na uchwyt Ø (mm)	☐
09363	50	35	6	75
09365	100	35	6	80

- PL Kuweta malarska
 GB Painting bowl
 D Malerschale
 RUS Ванночка малярная
- CZ Malířská kyveta
 RO Tava-suport trafalet
 H Kúvetta
 E Cuveta

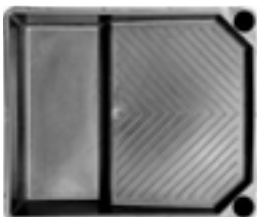

No.	mm	☐
09406	150x245	150
09408	330x350	60

- PL Zapas do walka Syntex
 GB Paint roller refill Syntex
 D Maler-Ersatzwalzen Syntex
 RUS Шубка полиакриловая для валика
- CZ Náhradní váleček Syntex
 RO Rezerva trafalet Acril Verde
 H Csere Syntex hengerhez
 E Repuesto para el cilindro Syntex



No.	roller width / szerokość walka W (mm)	cover pile height / wysokość poszycia A (mm)	hole diameter / średnica otworu na uchwyt Ø (mm)	☐
09310	180	20	6	10/40
09311	250	20	6	40

- PL Zapas do walka Girpaint
 GB Paint roller refill Girpaint
 D Maler-Ersatzwalzen Girpaint
 RUS Шубка полиамидная для валика
- CZ Náhradní váleček Girpaint
 RO Rezerva trafalet fir galben
 H Csere festőhenger Girpaint
 E Repuesto para el cilindro Girpaint



No.	roller width / szerokość walka W (mm)	cover pile height / wysokość poszycia A (mm)	hole diameter / średnica otworu na uchwyt Ø (mm)	☐
09338	100	9	6	150

- PL Zapas do walka Moltopren
 GB Paint roller refill Moltopren
 D Maler-Ersatzwalzen Moltopren
 RUS Шубка мольтопреп
- CZ Náhradní váleček Moltopren
 RO Rezerva trafalet burete
 H Csere festőhenger Moltopren
 E Esponja de recambio

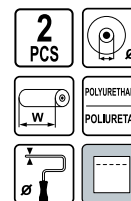

No.	roller width / szerokość walka W (mm)	roller diameter / średnica walka (mm)	hole diameter / średnica otworu na uchwyt Ø (mm)	☐
09375	50	35	6	200
09377	100	35	6	90
09378	150	50	6	45

- PL Kratka malarska
 GB Painting grid
 D Farbenabrollgitter
 RUS Решетка малярная
- CZ Malířská mřížka
 RO Grătar pt. zugrăvit
 H Festőrács
 E Rejilla para pintar

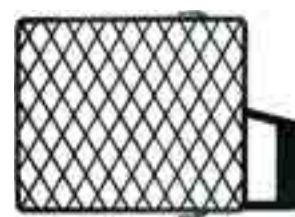

No.	mm	☐
09412	210x255	100
09413	265x285	100

- PL Walek malarski Vestan z kratką
 GB Paint roller set Vestan
 D Malerroller Vestan mit Abtropfgitter
 RUS Валик с решёткой
- CZ Malířský váleček + Mřížka
 RO Trafalet cu gratar
 H Festöhenger + rács
 E Rodillo de pintura + rejilla

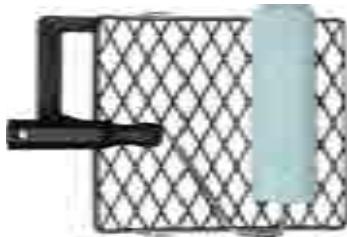

No.	W (mm)	handle / uchwyt Ø (mm)	
09385	180	6	25

- PL Walek malarski Moltopren z kuwetą
 GB Paint roller set Moltopren
 D Malerroller Moltopren mit Malerschale
 RUS Набор для покраски: ванночка, валик
- CZ Malířský váleček + kyveta
 RO Trafalet cu tava
 H Festöhenger + küvetta
 E Rodillo esponja + cuveta



No.	W (mm)	handle / uchwyt Ø (mm)	
09395	50	6	60

- PL Pędzel angielski
 GB Flat paint brush
 D Flachpinsel
 RUS Кисть флейцевая
- CZ Anglický štětec
 RO Pensulă englezească
 H Laposecset
 E Brocha plana

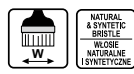

No.	brush width / szerokość pędzla W (mm)	bristle length / długość włosia (mm)	
09521	25	44/39	50
09522	36	51/46	50
09523	50	51/46	50
09524	63	51/46	50
09525	76	51/46	50

- PL Walek malarski Vestan z kuwetą
 GB Paint roller set Vestan
 D Malerroller Vestan mit Malerschale
 RUS Набор для покраски: ванночка, валик
- CZ Malířský váleček
 RO Trafalet cu tava
 H Festöhenger + küvetta
 E Rodillo de pelo + cuveta



No.	W (mm)	handle / uchwyt Ø (mm)	
09390	180	6	12

- PL Uchwyt do walka
 GB Paint roller handle
 D Malerroller-Griff
 RUS Ручка для валика
- CZ Držák válečku
 RO Maner trafalet
 H Festöhenger nyél
 E Mango del cilindro

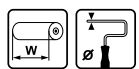

No.	roller width / szerokość walka W (mm)	hole diameter / średnica otworu na uchwyt Ø (mm)	
09421	50/70	6	90
09422	100	6	90
09425	150	6	150
09427	180	6	110
09429	250	6	110
09430	250	8	80

- PL Pędzel angielski profesjonalny
 GB Flat paint brush profi
 D Flachpinsel
 RUS Кисть флейцевая
- CZ Anglický štětec profesionální
 RO Pensulă englezească profesională
 H Profesionális laposecset
 E Brocha plana prof.



No.	brush width / szerokość pędzla W (mm)	bristle length / długość włosia (mm)	
09531	25	51/46	50
09532	36	51/46	50
09533	50	57/52	50
09534	62	57/52	50
09535	75	57/52	50
09536	87	64/59	50
09537	102	64/59	50

PL Pędzel kaloryferowy
GB Angled paint brush
D Heizkörperpinsel
RUS Кисть радиаторная

CZ Štětce na topná tělesa
RO Pensulă pt. calorifere
H Radiátorecset
E Broca angulada de radiadores



No.	brush width / szerokość pędzla W (mm)	bristle length / długość włosia (mm)	☐
09560	25	44/39	50
09561	36	51/46	50
09562	50	51/46	50

PL Pędzel do tapet
GB Brush for wallpapers
D Flächenstreicher
RUS Кисть-макловица деревянная ручка

CZ Štětce na tapety dřevěný
RO Bidinea profi pt. tapet
H Ecset fa tapétákhoz
E Brocha de empapelar madero



No.	brush width / szerokość pędzla W (mm)	bristle length / długość włosia (mm)	☐
09636	110x30	51/46	30
09638	130x30	51/46	30
09640	140x40	57/52	30
09642	150x50	64/59	30

PL Chlapacz PCV
GB Paint brush
D Malerbürste
RUS Кисть-макловица ПВХ

CZ Smeták PVC
RO Bidinea PVC
H PVC meszelő
E Brocha de PVC

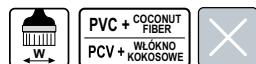

No.	brush width / szerokość pędzla W (mm)	☐
09651	170x60	30

PL Ławkowiec PET
GB Paint brush
D Malerbürste
RUS Кисть-макловица PET

CZ Natírací kartáč
RO Bidinea
H Kenőkefe
E Brocha



VOREL

No.	brush width / szerokość pędzla W (mm)	☐
09655	150x70	12
09650	170x70	12
09656	180x80	10

PL Pędzel okrągły
GB Round paint brush
D Ringpinsel
RUS Кисть круглая

CZ Kulatý štětce
RO Pensula rotundă
H Marokecset
E Brocha redonda

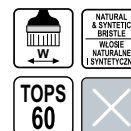

No.	brush width / szerokość pędzla W (mm)	bristle length / długość włosia (mm)	☐
09581	20	44/39	50
09583	30	51/46	50
09585	40	51/46	50
09587	50	57/52	50
09589	60	57/52	50

PL Ławkowiec
GB Paint brush
D Malerbürste
RUS Кисть-макловица деревянная ручка

CZ Natírací kartáč profesionální
RO Bidinea profesională
H Profesionális kenőkefe
E Brocha prof.



No.	brush width / szerokość pędzla W (mm)	bristle length / długość włosia (mm)	☐
09647	170x65	64/58	10
09648	180x75	70/64	10
09649	190x85	76/68	10

PL Pędzle malarskie
GB Paint brushes
D Pinselset
RUS Набор кистей

CZ Sada malířských štětců
RO Set pensule
H Festőecset készlet
E Brochas de pintar



No.	W (mm)	pcs	☐
09920	25; 36; 50	3	25/200
09930	36; 50; 63	3	40/160
09950	13; 25; 36; 50; 63	5	25/100

PL Smolowiec
GB Brush for pitch
D Pechstein
RUS Кисть для смолы

CZ Kartáč asfaltěský
RO Perie pt. asfalt
H Kátránykenő kefe
E Brocha para alquitrán



No.	mm	☐
09653	195	30

- PL Wielofunkcyjna podstawka gospodarca
 GB All purpose boot tray
 D Garten- & Haushalt-Unterlage
 RUS Многофункциональный поднос
 CZ Multifunkční podložka
 RO Tava multifunctionala
 H Többfunkciós tálcá
 E Bandeja de arranque universal

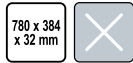

No.	mm	
67260	780x384x32	30

- PL Folia budowlana mocna
 GB Sheet for construction works
 D Abdeckplane
 RUS Плёнка защитная строительная повышенной прочности
- CZ Stavební fólie
 RO Folie pt. construcții
 H Építési fólia
 E Lona protectora



No.	m	µm	
09457	4x5	20	15
09459	4x5	30	10

- PL Worki na odpady, budowlane
 GB Construction waste bags
 D Müllsäcke
 RUS Мешки для строительного мусора
- CZ Pytle na stavební odpad
 RO Saci gunoi pt. santier
 H Zsák építési törmelékhez
 E Bolsas para desperdicios de construcción



No.	l	pcs / packing	µm	
09470	80	10	40	30
09471	120	15	60	10

- PL Taśma papierowa samoprzylepna
 GB Self adhesive paper tape
 D Papierband selbstklebend
 RUS Лента малярная бумажная
- CZ Páska papírová samolepící
 RO Banda adeziva hartie
 H Öntapadó papírszalag
 E Cinta de papel adhesiva



- PL Folia ochronna malarska
 GB Sheet for construction works
 D Abdeckplane
 RUS Плёнка защитная
- CZ Stavební fólie
 RO Folie pt. construcții
 H Építési fólia
 E Lona protectora



No.	m	µm	material / material	
09462	4x5	5	HDPE	40
09463	4x5	15	LDPE	20

- PL Worki na gruz, mocne
 GB Debris bags
 D Müllsäcke stabil
 RUS Мешки для строительного мусора
- CZ Pytle na sut
 RO Saci pt. demolari
 H Sittes zsák
 E Bolsas para escombros



No.	l	pcs / packing	µm	
09475	80	10	142	10
09476	80	3	142	10
09477	120	10	142	10
09478	120	3	142	10

- PL Worki na styropian
 GB Waste bags for styrofoam
 D Styropor Entsorgungssäcke
 RUS Пакеты для мусора строительные материалы
- CZ Pytle na polystyren
 RO Saci gunoi
 H Szemeteszsák
 E Sacos de poliestireno

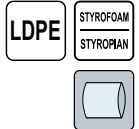

No.	l	pcs / packing	µm	
09472	240	10	40	10



No.	W (mm)	L (m)	
75270	19	25	12/48
75271	25	25	36
75272	30	25	10/40
75273	38	25	6/24
75274	48	25	6/24
75285	25	50	9/36
75286	30	50	10/40
75287	38	50	6/24
75288	48	50	6/24

PL Taśma maskująca, niebieska
GB Blue masking tape
D Malerei blau Tape
RUS Малярна стрічка

CZ Maskovací páska
RO Bandă de mascare
H Fedőszalag
E Cinta de enmascarar



No.	W (mm)	L (m)	
75120	30	25	40
75121	38	25	24
75122	48	25	24
75123	30	50	40
75124	38	50	24
75125	48	50	24

PL Taśma aluminiowa
GB Aluminium tape
D Aluminiumband
RUS Алюминиевая клейкая лента

CZ Hliníková páska
RO Bandă aluminiu
H Aluminium szalag
E Cinta de aluminio



No.	W (mm)	L (m)	
75140	48	10	36
75141	48	50	24

PL Taśma tekstylna „DUCT”
GB „DUCT” tape
D Textilband „DUCT”
RUS Лента армированная на тканевой основе

CZ Textilní páska „DUCT”
RO Bandă textilă „DUCT”
H „DUCT” textil szalag
E Cinta textil „DUCT”



No.	W (mm)	L (m)	
75238	48	10	36
75239	38	50	32
75240	48	50	24

PL Taśma tynkarska elewacyjna
GB Plastering tape
D Putzband
RUS Штукатурные лента

CZ Fasádní omítková páska
RO Banda mascare pt. tencuelii
H Homlokzati festő szalag
E Cinta de escayola

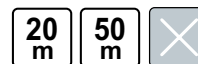

No.	W (mm)	L (m)	
75130	38	20	24
75131	48	20	24
75132	38	50	28
75133	48	50	24

PL Taśma dwustronna do wykładzin
GB Double-sided carpet tape
D Doppelseitiges Klebeband für Auslegware
RUS Двухсторонняя клейкая лента для укладки ковровых покрытий
CZ Obojstranná lepicí páska (na podlahové krytiny)
RO Bandă cu două părți adezive pt. mochete
H Kétoldalas szalag szőnyegpadlókhöz
E Cinta doble cara para alfombras



No.	W (mm)	L (m)	
75260	50	5	48
75261	50	10	36
75262	50	25	24

PL Taśma dwustronna na folii
GB Double-sided tape
D Doppelseitiges Band auf PP-Folie
RUS Клейкая лента двухсторонняя на полипропиленовой основе
CZ Obojstranná páska na PP folii
RO Bandă cu două fețe pt. folii
H Kétoldalas
E Cinta doble cara sobre la base de PP



No.	W (mm)	L (m)	
75245	50	5	72
75246	50	10	72
75247	50	25	36

- PL Taśma samoprzylepna dwustronna
 GB Mounting tape
 D Doppelseitiges Montageband
 RUS Двухсторонняя монтажная лента
- CZ Páska montážní dvouvrstvá
 RO Scotch cu banda dubla
 H Kétoldalas ragasztószalag
 E Cinta adhesiva, ambos lados

2
PCS

19mm x 5m
19mm x 2.25m



No.	W (mm)	L (m)	
75100	19	2.25	5

- PL Taśma pakowa przezroczysta
 GB Packing tape, transparent
 D Verpackungsband aus PP, durchsichtig
 RUS Упаковочная клейкая лента
- CZ Balicí páska PP průhledná
 RO Bandă ambalare PP transparentă
 H Átlátszó ragasztószalag
 E Cinta de embalaje PP transparente



No.	W (mm)	L (m)	
75303	48	40	72
75304	48	66	36

- PL Taśma PCV do użytku zewnętrznego
 GB PVC tape
 D PVC Band
 RUS Лента ПВХ для внешних работ
- CZ Páska PVC
 RO Bandă PVC
 H Kétoldalas PVC
 E Cinta PVC

INSIDE AND OUTSIDE
 APPLICATION (UP TO 2 WEEKS)
 ZASTOSOWANIE WEWNĄTRZ
 I NA ZEWNĄTRZ (DO 2 TYGODNI)

UV PROOF
 ODPORNA NA
 PROMIENIOWANIE UV



No.	W (mm)	L (m)	
75031	48	33	50

- PL Wiadro budowlane z wylewką
 GB Plastic bucket
 D Baueimer
 RUS Ведро строительное со сливом
 CZ Stavební vědro
 RO Găleată pt. construcții
 H Kőműves vödör
 E Cubo de obra con pico



No.	l	
06391	12	720

- PL Taśma pakowa brązowa
 GB Packing tape, brown
 D Verpackungsband aus PP, braun
 RUS Упаковочная клейкая лента
- CZ Balicí páska PP hnědá
 RO Bandă ambalare PP maro
 H PP barna ragasztószalag
 E Cinta de embalaje PP marrón



No.	W (mm)	L (m)	
75301	48	40	72
75302	48	66	36

- PL Taśma pakowa
 GB Packing tape
 D Band
 RUS Упаковочная клейкая лента
- CZ Balicí páska
 RO Bandă scotch
 H Csomagolószalag
 E Cinta de embalaje



No.	W (mm)	L (m)	
75300	48	45	12/120

- PL Wiadro budowlane
 GB Plastic bucket
 D Baueimer
 RUS Ведро строительное
 CZ Stavební vědro
 RO Găleată pt. construcții
 H Kőműves vödör
 E Cubo de obra



No.	l	
06388	10	900
06390	12	680
06393	16	450
06392	20	390

- PL Wiadro malarskie
 GB Painting bucket
 D Malereimer
 RUS Ведро малярное пластмассовое
- CZ Vědro malířské
 RO Găleată zidar
 H Festvödör
 E Cubo para pintar



No.	l	mm	
09400	14	360x250x225	315

PL Kastrą budowlaną
GB Tub for mass mixing
D Mörtelkasten
RUS Таз строительный круглый

CZ Stavební vědro
RO Vas plastic constructii
H Kőműves vödör
E Cuba de obra



VOREL

No.	l	
06397	40	110
06398	65	100
06399	90	160

PL Wiadro ogrodnicze
GB Garden bucket
D Garten Eimer
RUS Ведро огородное

CZ Zahradní vědro
RO Găleată de grădină
H Kerti vödör
E Cubo de jardín



FLO

No.	l	
35600	15	500

PL Uchwyt do szyb
GB Suction lifter
D Glas-Gummissauger
RUS Держатель-присоска для стекол одинарная

CZ Podtlakový úchyt na sklo
RO Ventuze
H Szélvédő kiemelő
E Elevadores tipo ventosa



VOREL

No.	Ø (mm)	kg	
05300	115	40	48

PL Uchwyt do szyb
GB Suction lifter
D Glas-Gummissauger
RUS Держатель-присоска для стекол тройная

CZ Podtlakový úchyt na sklo
RO Ventuze
H Szélvédő kiemelő
E Elevadores tipo ventosa



VOREL

No.	Ø (mm)	kg	
05302	115	100	12

PL Kastrą budowlaną
GB Tub for mass mixing
D Mörtelkasten
RUS Кювета для перемешивания раствора

CZ Stavební vědro
RO Vas plastic constructii
H Kőműves vödör
E Cuba de obra



No.	l	
06394	40	210
06395	60	210
06396	90	120

PL Wiadro ocynkowane
GB Galvanized bucket
D Baueimer
RUS Ведро оцинкованное
CZ Vědro
RO Găleată
H Kőműves vödör
E Cubo



VOREL

No.	l	
89560	5	900
89561	7	450
89562	10	600
89563	12	500
89564	15	400

PL Uchwyt do szyb
GB Suction lifter
D Glas-Gummissauger
RUS Держатель-присоска для стекол двойная

CZ Podtlakový úchyt na sklo
RO Ventuze
H Szélvédő kiemelő
E Elevadores tipo ventosa

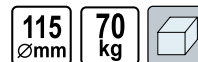

VOREL

No.	Ø (mm)	kg	
05301	115	70	24

PL Uchwyt do szyb
GB Suction lifter
D Glas-Gummissauger
RUS Держатель-присоска для стекол одинарная

CZ Podtlakový úchyt na sklo
RO Ventuze
H Szélvédő kiemelő
E Elevadores tipo ventosa

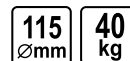

VOREL

No.	Ø (mm)	kg	
05311	115	40	50

- PL Uchwyt do szyb
GB Suction lifter
D Glas-Gummissauger
RUS Держатель-присоска для стекол двойная
- CZ Podtlakový úchyt na sklo
RO Ventuze
H Szélvédő kiemelő
E Elevadores tipo ventosa



No.	Ø (mm)	kg	box
05312	115	70	10

- PL Ołówek stolarski
GB Carpenter's pencil
D Zimmermannsbleistift
RUS Карандаш столярный
- CZ Tesařská tužka
RO Creion de tâmplărie
H Asztalos ceruza
E Lapiz de carpintero



No.	L (mm)	pcs packing	box
09180	180	12	60/240

- PL Klucz do wiązania drutu zbrojeniowego
GB Wire tying twister hook
D Rödeldraht-Drillkurbel
RUS Крючок для вязки арматуры
- CZ Radlovačka
RO Dispozitiv pt. legat fier beton
H Huzalsodró
E Gancho para amarrar alambre



No.	L (mm)	box
49830	240	20

- PL Giętarka do drutu zbrojeniowego
GB Bender for reinforcement bar
D Biegevorrichtung für Bewehrungsdraht
RUS Ручной станок для гибки арматуры
- CZ Ohýbačka armovacího drátu
RO Dispozitiv pt. indoit sarmă de armare
H Betonvas hajlító
E Dobladora de alambre de reforzamiento



No.	Ø (mm)	mm	box
49800	6-8	16x12x5	4
49801	10-12	25x16x6	4
49802	14-16	25x16x6	2

- PL Hak budowlany
GB Hook
D Mauerhaken
RUS Крюк строительный
- CZ Stavební hák
RO Cârlig de construcții
H Építőipari horog
E Gancho de obra



No.	box
34950	25

- PL Temperówka do ołówek stolarskich
GB Carpenter's pencil sharpener
D Zimmermann-Bleistift-Anspitzer
RUS Точилка для столярных карандашей
- CZ Ořezávkto na tesařskou tužku
RO Ascuzitoare pt. creioane de tamplarie
H Ceruzahegyező
E Sacapuntas para lápiz de carpintero



No.	box
09190	40/240

- PL Giętarka łożyskowana do drutu
GB Bearing bender for bar
D Drahtbiegevorrichtung, mit Lager
RUS Ручной станок для гибки арматуры
- CZ Ohýbačka drátu s ložiskem
RO Dispozitiv pt. indoit suport sarmă
H Csapágyvas dróthajlító
E Dobladora de alambre con rodamiento



No.	Ø (mm)	mm	bearing / łożysko (mm)	box
49805	6-8	17x17x5	35x15	2
49806	10-14	25x20x5	45x20	2

- PL Chwytnak brukarski wzdużny regulowany
GB Longitudinal clamp
D Bordstein-Verlegezange
RUS Захват-клеци для бордюра продольные
- CZ Kleště na obrubníky podélné
RO Cleste pt. borduri
H Hosszirányúszegélykő emelő fogó
E Pinza de colocación de rebordes mecánica



No.	grip range / zakres chwytu (mm)	box
35010	750-1000	2

- PL Chwytek poprzeczny, podwójny
 GB Lateral clamp
 D Bordsteinverlegezange
 RUS Захват-клевцы для бордюра поперечные
- CZ Kleště na obrubníky příčné
 RO Cleste pt. borduri
 H Keresztirányúszegélykő emelő fogó
 E Pavimentación pinza doble



VOREL

No.	grip range / zakres chwytu (mm)	4
35012	50-240	4

- PL Chwytek zbiorczy do kostki brukowej
 GB Grapple for cobblestones
 D Pflastersteineträger
 RUS Захват ручной для переноса бордюрного камня и блоков
- CZ Nosič na cihly
 RO Cleste pt. borduri
 H Emelő fogó
 E Pinza para bordillos longitudinal



VOREL

No.	grip range / zakres chwytu (mm)	4
35015	700-1100	4

- PL Imak brukarski regulowany
 GB Paver puller
 D Steinzieher-Steinheber
 RUS Захват для камня
- CZ Kleště na vytahování dlažby
 RO Ridicator de pavele
 H Térkökiemelő szerszám
 E Extractor de adoquines



VOREL

No.	grip range / zakres chwytu (mm)	4
35020	60-260	4

- PL Łom wyważak brukarski
 GB Paver adjuster
 D Richteisen für Pflasterbau
 RUS Лом с упором для демонтажа тротуарной плитки
- CZ Tyč pro opravu dlažby
 RO Bara de aliniere pavaj
 H Térkö sorrendező
 E Barra alineadora de adoquines



VOREL

No.	4
35025	4

- PL Zapasowe końcówki do chwytaka
 GB Rubber for lateral clamp
 D Ersatzgummi für Bordsteinverlegezange
 RUS Запасные наконечники
- CZ Náhradní gumový úchyt
 RO Mânere de cauciuc de rezervă
 H Gumi alkatrészek
 E Punta de repuesto

4
PCS



VOREL

No.	for / dla	pcs	10
35013	35012	4	10

- PL Chwytek brukarski jednoręczny regulowany
 GB Slabgrabber
 D Pflasterstein- und Klinker-Träger
 RUS Захваты для тротуарной плитки кирпич, блоков
- CZ Kleště na dlažbu a cihly
 RO Cleste pt. caramizi
 H Burkolólap fogó
 E Pinza de colocación de losas



VOREL

No.	grip range / zakres chwytu (mm)	4
35017	280-500	4

- PL Zapasowe ostrza do imaka
 GB Blades for paver puller
 D Ersatzklingen für Steinzieher-Steinheber
 RUS Запасные лезвия
- CZ Náhradní čepel
 RO Tartalék penge
 H Lame de rezervă
 E Cuchillas de repuesto

2
PCS



VOREL

No.	for / dla	pcs	20
35021	35020	2	20

- PL Ostrze do łomu brukarskiego
 GB Blade for paver adjuster
 D Ersatzklingen für Richteisen
 RUS Запасные лезвия
- CZ Náhradní čepel
 RO Lame de rezervă
 H Tartalék penge
 E Cuchillas de repuesto



VOREL

No.	for / dla	20
35026	35025	20

- PL Zgarniacz brukarski do podsypki
- GB Paver lifter
- D Plan-Abzieher für Pflasterbau
- RUS Правило для выравнивания основания под тротуарную плитку
- CZ Stahovací lišta
- RO Sistem de nivelare manuala
- H Ágyazat lehúzó rendszer
- E Sistema de enrasado manual



No.	L (cm)	
35031	150	1
35030	200	1

- PL Zgarniacz brukarski do podsypki
- GB Paver lifter
- D Plan-Abzieher für Pflasterbau
- RUS Правило для выравнивания основания под тротуарную плитку
- CZ Stahovací lišta
- RO Sistem de nivelare manuala
- H Ágyazat lehúzó rendszer
- E Sistema de enrasado manual



No.	L (cm)	
35033	75	1
35032	120	1

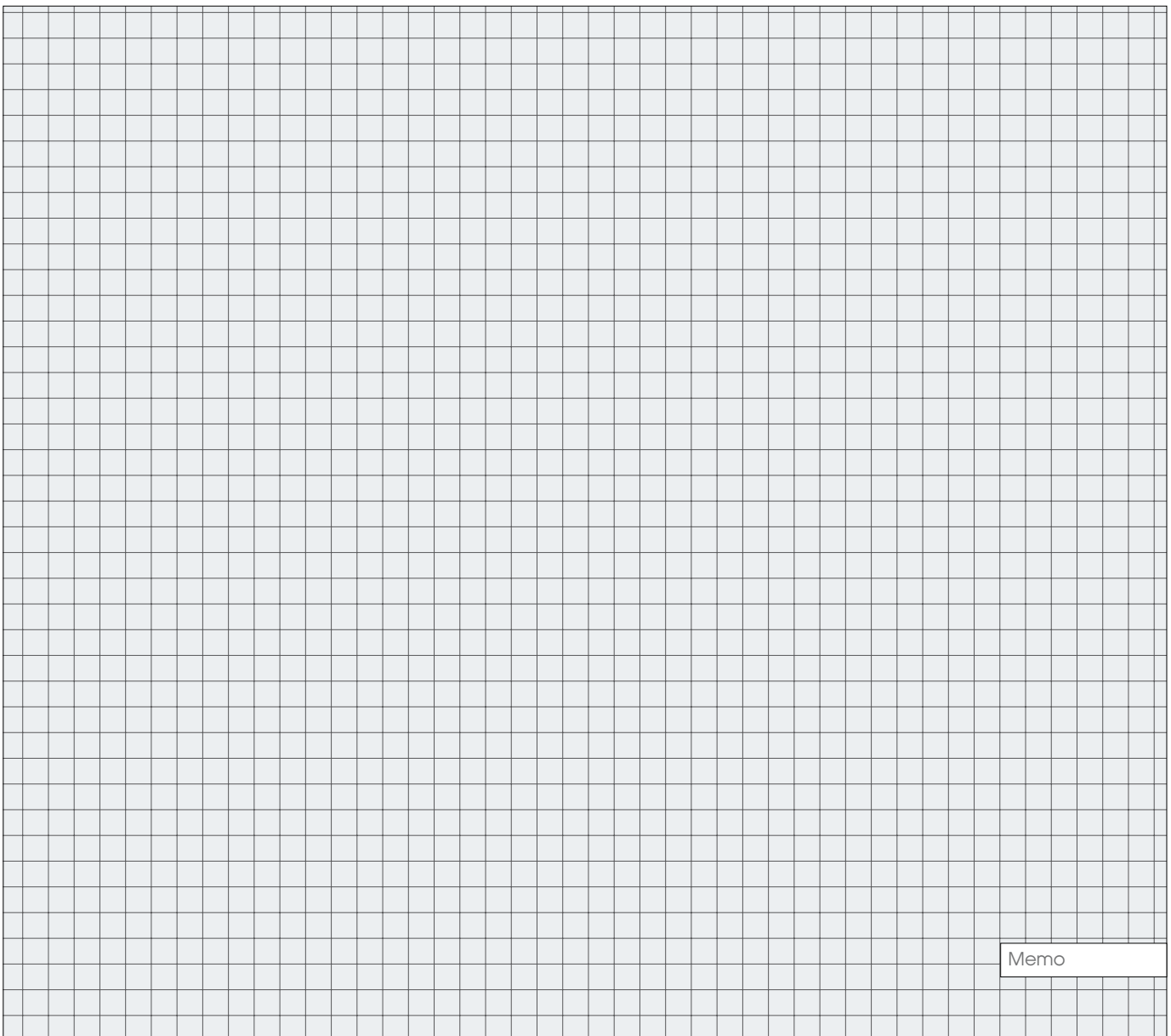

Memo

12

Measuring tools Narzędzia miernicze



Measuring tapes
Miary zwijane

.....166

**Wooden folding rules**
Miary składane drewniane

.....167

**Plastic folding rules**
Miary składane z tworzywa

.....167

**Feeler gauges**
Szczelinomierze

.....167

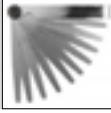
**Vernier calipers**
Suwmiarki

.....167

**Chalk lines**
Sznury traserskie

.....168

**Ropes & lines**
Sznury i linki

.....168-170

**Plumb bobs**
Piony murarskie

.....170

**Try squares**
Kątowniki stolarskie

.....170-171

**Rulers**
Przymiary

.....171

**Electronic measuring tools**
Elektroniczne urządzenia pomiarowe

.....172

**Levels**
Poziomnice

.....172-173



PL Miara zwijana
GB Measuring tape
D Rollbandmass
RUS Рулетка
CZ Měřicí pásmo
RO Rulete din
H Mérőszalag
E Flexometro



VOREL

No.	L (m)	W (mm)	Icon
10101	2	16	12/120
10104	3	16	12/120
10106	5	16	12/120
10109	7.5	19	6/60
10111	10	25	6/60

PL Miara zwijana
GB Measuring tape
D Rollbandmass
RUS Рулетка
CZ Měřicí pásmo
RO Rulete din
H Mérőszalag
E Flexometro



VOREL

No.	L (m)	W (mm)	Icon
10130	2	16	12/120
10133	3	16	12/120
10135	5	16	12/120
10138	8	25	6/60
10139	10	25	6/60

PL Taśma miernicza stalowa
GB Steel measuring tape
D Rollbandmass
RUS Мерная лента стальная



No.	L (m)	W (mm)	Icon
12100	10	10	25/50
12200	20	10	25/50
12300	30	10	10/30
12500	50	10	10/30

PL Taśma miernicza stalowa, geodezyjna
GB Steel measuring tape
D Rollbandmass
RUS Мерная лента стальная геодезическая

CZ Měřicí pásmo ocelové
RO Ruleta cu picior
H Acél mérőszalag
E Cinta de mednir de acero geodezico



No.	L (m)	Icon
13200	20	10/20
13300	30	10/20
13500	50	10/20

PL Miara zwijana
GB Measuring tape
D Rollbandmass
RUS Рулетка
CZ Měřicí pásmo
RO Rulete din
H Mérőszalag
E Flexometro



VOREL

No.	L (m)	W (mm)	Icon
10122	2	16	12/120
10123	3	16	12/120
10125	5	19	12/120
10128	7.5	25	6/60
10129	10	25	6/60

PL Miara zwijana
GB Measuring tape
D Rollbandmass
RUS Рулетка

CZ Měřicí pásmo
RO Rulete din
H Mérőszalag
E Flexometro

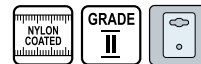

VOREL

No.	L (m)	W (mm)	Icon
11310	3	16	12/120
11311	5	19	12/120
11313	8	25	6/60

PL Miara zwijana stalowa
GB Steel measuring tape
D Rollbandmass
RUS Мерная лента стальная



VOREL

No.	L (m)	W (mm)	Icon
12502	20	10	6/30
12503	30	10	6/30

PL Taśma miernicza z włókna szklanego
GB Fibreglass measuring tape
D Rollbandmass
RUS Мерная лента фиброгласовая

CZ Měřicí pásmo /skleněné vlákno/
RO Ruleta fibra sticla
H Mérőszalag /üvegszál/
E Cinta de medir /fibra cristal/



No.	L (m)	packing	Icon
14100	10		20/100
14200	20		12/60
14300	30		12/60
14500	50		10/30

PL Miara drewniana, składana, okuta
 GB Wooden folding rule
 D Gliedemasstab
 RUS Метр складной деревянный

CZ Měřicí pásmo dřevěné skladané /okované/
 RO Metru tamplar lemn
 H Fa colstok /vasalt/
 E Metro de madera, plegable /articulado/



No.	L (m)	
15010	1	24/480
15020	2	12/240

PL Miara drewniana, składana, okuta
 GB Wooden folding rule
 D Gliedemasstab
 RUS Метр складной деревянный

CZ Měřicí pásmo dřevěné skladané /okované/
 RO Metru tamplar lemn
 H Fa colstok /vasalt/
 E Metro de madera, plegable /articulado/



No.	type	L (m)	
15005	PERFECT B	1	20/200
15007	PERFECT B	2	10/100

PL Szczelinomierz
 GB Feeler
 D Fühlerlehre
 RUS Щупы автомобильные

CZ Spároměr
 RO Lere
 H Hézagmérő
 E Calibre de fisuras



No.	mm	pcs	
15130	0.05-1.00	13	15/300
15200	0.05-1.00	20	10/200

PL Suwmiarka zegarowa
 GB Dial caliper
 D Präzisions-Uhrmessschieber
 RUS Штангенциркуль стрелочный

CZ Posuvné měřítko hodinové
 RO Şubler cu cadran
 H Órás tolómérő
 E Calibre dial

150 mm



No.	L (mm)	mm	
15220	150	0.02	10/50

PL Miara drewniana, składana, okuta
 GB Wooden folding rule
 D Gliedemasstab
 RUS Метр складной деревянный

CZ Měřicí pásmo dřevěné skladané /okované/
 RO Metru tamplar lemn
 H Fa colstok /vasalt/
 E Metro de madera, plegable /articulado/



No.	type	L (m)	
15004	PERFECT B-Ž	1	20/200
15006	PERFECT B-Ž	2	10/100

PL Miara plastikowa
 GB Plastic folding rule
 D Kunststoffgliedmasstab
 RUS Метр складной пластмассовый

CZ Měřicí pásmo plastové skladané
 RO Metru de plastic
 H Műanyag, összehajtható mérce
 E Metro de plástico, plegable



No.	L (m)	
15050	1	20/200
15070	2	12/120

PL Suwmiarka
 GB Vernier caliper
 D Messschieber
 RUS Штангенциркуль

CZ Posuvné měřítko
 RO Şubler
 H Tolómérő
 E Calibre

150 mm



No.	L (mm)	mm	packing	
15100	150	0.05		40
15110	150	0.02		10/100

PL Suwmiarka elektroniczna
 GB Digital caliper
 D Digital Messschieber
 RUS Штангенциркуль электронный

CZ Posuvné měřítko elektronické
 RO Şubler electronic
 H Elektronikus tolómérő
 E Calibre electronic

150 mm



No.	L (mm)	mm	
15240	150	0.03	10/50

PL Sznur traserski
GB Chalk line
D Schnurlot
RUS Шнур-отвес
малярный

CZ Orysováci šňúra
RO Şnur de trasat
H Kicsapózsínor
E Cordel tizador



No.	L (m)	Box icon
17500	15	10/100

PL Sznur traserski z kredą niebieską
GB Chalk line & blue chalk
D Schlagschnur mit Kreide
RUS Шнур-отвес малярный + краска

CZ Orysováci šňúra
RO Fir trasare si praf de creta albastra
H Kicsapózsínor
E Cordel tizador con tiza azul



VOREL

No.	L (m)	g	Box icon
17505	15	115	10/60

PL Sznurek murarski
GB Builders line
D Maurerschnur
RUS Шнур - причалка

CZ Šňúra zednická
RO Sfoară pt. zidari
H Kőműves zsinór
E Cuerda de albañil



No.	L (m)	Box icon
17490	40	80

PL Sznurek murarski
GB Builders line
D Maurerschnur
RUS Шнур каменщика

CZ Šňúra zednická
RO Sfoară pt. zidari
H Kőműves zsinór
E Cuerda de albañil



No.	L (m)	colour / kolor	Box icon
17488	50	Yellow dot	60
17489	100	Yellow dot	60

PL Sznur traserski
GB Chalk line
D Schnurlot
RUS Шнур-отвес малярный

CZ Orysováci šňúra
RO Şnur de trasat
H Kicsapózsínor
E Cordel tizador



VOREL

No.	L (m)	Box icon
17501	15	10/100

PL Kreda traserska
GB Blue / red chalk
D Kreide blau / rot
RUS Краска для шнура

CZ Křída trasovací
RO Praf de creta pt. trasat
H Jelölő krétaport
E Tiza azul/rojo



VOREL

No.	g	colour / kolor	Box icon
17507	115	Blue dot	20/80
17508	115	Red dot	20/80

PL Sznurek murarski
GB Builders line
D Maurerschnur
RUS Шнур каменщика
CZ Šňúra zednická
RO Sfoară pt. zidari
H Kőműves zsinór
E Cuerda de albañil



VOREL

No.	L (m)	Box icon
17495	75	12/48

PL Sznurek murarski, polipropylenowy
GB Polypropylene bricklayer's string
D Maurerschnur aus Polypropylen
RUS Шнур каменщика

CZ Šňúra zednická polypropylenová
RO Şnur de zidărie din polietilena
H Kőműves zsinór, polipropilén
E Cordel de albañilería



VOREL

No.	Ø (mm)	L (m)	Box icon
17470	1.7	50	60/240
17471	1.7	100	30/120
17473	2.0	50	60/240
17474	2.0	100	30/120

PL Sznurek murarski polietylenowy
 GB Polyethylene bricklayer's string
 D Maurerschnur aus Polyäthylen
 RUS Полиэтиленовый шнур каменщика

CZ Šňúra zednická polyetylenová
 RO Șnur de zidărie din polietilena
 H Kőműves zsinór, polietilén
 E Cordel de albañilería de polietileno



VOREL

No.	Ø (mm)	L (m)	
17480	1.7	50	60/240
17481	1.7	100	30/120
17483	2.0	50	60/240
17484	2.0	100	30/120

PL Linka pleciona polipropylenowa
 GB Polypropylene sennit line
 D Geflochtenes Seil aus Polypropylen
 RUS Канат полипропиленовый

CZ Lano pletené polypropylenové
 RO Coarda împletită din polipropilena
 H Polipropilén fonott kötél
 E Cuerda trenzada de polipropileno



VOREL

No.	Ø (mm)	L (m)	
69521	4	20	50

PL Sznurek PP pleciony, uniwersalny
 GB Universal PP sennit string
 D PP-Schnur, geflochten, universell
 RUS Шнур полипропиленовый

CZ Šňúra PP pletená univerzální
 RO Șnur PP împletit, universal
 H PP fonott kötél, univerzális
 E Cordel trenzado universal PP



VOREL

No.	Ø (mm)	L (m)	
69620	3	10	50
69621	3	20	40

PL Sznurek pakowy, jutowy
 GB Packing jute string
 D Packschnur, aus Jute
 RUS Шнур джутовый

CZ Šňúra ucpávková jutová
 RO Șnur de împachetat, de iuta
 H Csomagkötöző spárga, juta
 E Cordel de yute para embalaje



VOREL

No.	dkg	
69630	5	112
69631	10	100

PL Linka pleciona polipropylenowa
 GB Polypropylene sennit line
 D Geflochtenes Seil aus Polypropylen
 RUS Канат полипропиленовый плетёный

CZ Lano pletené polypropylenové
 RO Coarda împletită din polipropilena
 H Polipropilén fonott kötél
 E Cuerda trenzada de polipropileno



VOREL

No.	Ø (mm)	L (m)	
69502	4	400	4
69503	5	250	4
69504	6	250	4
69505	8	300	2
69506	10	200	2
69507	12	180	1
69508	14	110	1
69509	16	80	1
69510	18	70	1

PL Lina jutowa skręcana
 GB String jute rope
 D Verdrihtl Seil aus Jute
 RUS Канат джутовый

CZ Lano jutová kroucená
 RO Cablu răsucit de iuta
 H Juta sodrott kötél
 E Cable de yute torcido



VOREL

No.	Ø (mm)	L (m)	
69572	10	10	40

PL Nici lniane, dratwa
 GB Flax thread, twine
 D Leinenfaden, Pechfaden
 RUS Нить (дратва) льняная

CZ Nítě lněné, dratev
 RO Fire de in, fire
 H Len cérna, fonál
 E Hilo de lino, cabo de zapatero



VOREL

No.	dkg	
69635	10	28
69637	25	18

- PL Lina iglowa
GB Needle rope
D Nadelsēil
RUS Канат полипропиленовый, плетеный
- CZ Lano s jádrem opletené
RO Cablu ac
H Tűfonatos kötél
E Cable acalabrotado



VOREL

No.	Ø (mm)	L (m)	
69539	8	10	30
69540	8	20	20
69542	10	10	25
69543	10	20	15
69546	12	20	10

- PL Linka pleciona, elastyczna
GB Elastic sennit line
D Geflochtenes Seil, elastisch
RUS Канат плетеный эластичный
- CZ Lano pletené elastické
RO Coarda împletita, elastica
H Fonott kötél, rugalmas
E Cuerda trenzada elástica

RUBBER CORE
GUMOWY RDZEN



VOREL

No.	Ø (mm)	L (m)	
69550	6	150	1
69551	8	100	1
69552	10	100	1

- PL Pion murarski z mocowaniem magnetycznym
GB Magnetic plumb
D Senklot mit Haltemagnet
RUS Магнитный строительный отвес
CZ Olovnice se magnetu
RO Fir cu plumb magnetic
H Fűggőn
E Fios de prumo com íman



6m 400g



VOREL

No.	m	
17310	6	6/36

- PL Kałownik stolarski
GB Try square
D Zimmermannswinkel
RUS Угольник столярный
- CZ Truhlářský úhelník
RO Echer (unghi drept) de tâmplărie
H Asztalos derékszög
E Escuadra de metalo



VOREL

No.	mm	
18201	200x300	24/48
18200	400x600	12/24

- PL Sznurek PP do podwazywania welny izolacyjnej
GB Spliced wire polypropylene string
D Polypropylen Erntegar
RUS Шнур полипропиленовый
CZ Provázek polypropylenový
RO Snur din polipropilena
H Špagát polypropylénový
E Cuerda



VOREL

No.	Ø (mm)	L (m)	
69608	2.5	200	100
69609	2.5	300	80
69610	2.5	450	50
69612	2.5	1000	24
69613	2.5	2000	12

- PL Pion murarski
GB Plumb bob
D Senklot
RUS Отвес со шнуром
- CZ Murařská centrace
RO Fir cu plumb
H Kőműves függőn
E Plomada albañil



No.	size / rozmiar (mm)	
17300	15x70	200

- PL Kałownik stolarski
GB Try square
D Zimmermannswinkel
RUS Угольник столярный
- CZ Truhlářský úhelník
RO Echer (unghi drept) de tâmplărie
H Asztalos derékszög
E Escuadra de metalo



No.	mm	
18250	250	12/120
18300	300	12/120
18350	350	12/120

- PL Kałownik aluminiowy
GB Aluminium try square
D Alu-Zimmermannswinkel
RUS Угольник столярный алюминиевый
- CZ Truhlářský úhelník
RO Echer (unghi drept) de tâmplărie
H Asztalos derékszög
E Escuadra



VOREL

No.	mm	
18360	250	10/60
18361	300	10/60
18362	350	10/60

- PL Kątownik z podpórką
 GB Angle bar with a support
 D Winkel mit Stütze
 RUS Угольник столярный с откидным упором
- CZ Úhelník s dorazem
 RO Cornier cu stand
 H Támaszos derékszögélő
 E Escuadra con soporte



No.	mm	☐
18501	350	30
18502	500	30
18503	750	20
18504	1000	10

- PL Kątomierz z libellą i ruchomym ramieniem
 GB Protractor with level
 D Winkelmesser
 RUS Транспортир

- CZ Protractor
 RO Mușchi extensor
 H Szögmérő
 E Transportador

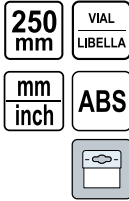

No.	mm	vials / libelle	☐
18473	250	1	10/60

- PL Skośnica drewniana
 GB Bevel protractor
 D Schmiege
 RUS Угольник регулируемый деревянный

- CZ Nastavitelný úhloměr
 RO Echer reglabil
 H Állítható szögmérő
 E Calibrador de biseseles



No.	mm	☐
18800	270	80
18810	400	60

- PL Przymiar do tapet
 GB Carpenter's ruler
 D Zeichen-Masstab
 RUS Линейка стальная с деревянной ручкой

- CZ Měřidlo stavební
 RO Rigla de tamplarie
 H Kőműves vonalzó
 E Regla de obra



No.	mm	☐
19750	750	10/40

- PL Kątomierz nastawny
 GB Bevel protractor
 D Winkelmesser
 RUS Угломер регулируемый со шкалой

- CZ Nastavitelný úhloměr
 RO Echer reglabil
 H Állítható szögmérő
 E Calibrador de biseseles



No.	mm	☐
18797	350	10
18798	500	10
18799	750	10

- PL Kątomierz elektroniczny z poziomnicą
 GB Protractor electronic with spirit level
 D Digital Winkelmesser mit Wasserwaage
 RUS Транспортир электронный с уровнем

- CZ Protractor electronic s urovni
 RO Protractor electronic cu nivel
 H Szögmérő elektronikusak szint
 E Con el nivel electrónico transportador

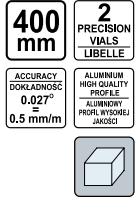

No.	mm	vials / libelle	☐
17570	240	2	20

- PL Kątownik nastawny do przenoszenia wymiarów
 GB Adjustable ruler
 D Multifunktionales Messlineal
 RUS Разметочный инструмент линейка-шаблон

- CZ Pokosník nastavitelní
 RO Echer reglabil
 H Szögmérőtétek
 E Medición del ángulo

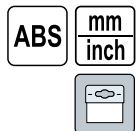

No.	☐
18470	20/60

- PL Przymiar aluminiowy, uchwyt, 2 libelki
 GB Aluminium ruler, 2 vials
 D Alu Zeichen-Masstab 2-lib
 RUS Линейка столовая алюминиевая 2 глаза с ручкой

- CZ Měřidlo hliníkové
 RO Rigla de aluminiu cu 2 bule
 H Alumínium vonalzó
 E Regla de aluminio, mango, division 2-burbujas



No.	mm	vials / libelle	☐
19770	600	2	12/24

- PL Dalmierz ultradźwiękowy z laserem
- GB Ultrasonic distance meter with laser
- D Ultraschall Entfernungsmesser mit Laserpointer
- RUS Ультразвуковой измеритель расстояния
- CZ Ultrazvukový měřič vzdálenosti
- RO Aparat masurat distanta cu laser
- H Léyeres, ultrahangos távolságmérő
- E Distanciómetro de ultrasonido con láser



0.9145 m	0.5% ACCURACY DOKŁADNOŚĆ
M1 M2 M3 3 x MEMORY 3 x PAMIĘĆ	M1 AREA POWERZCZYNIA
VOLUME GŁOŚNOŚĆ	LASER
9V (6F22) BATTERY BATERIA	



No.	← m	battery / bateria	
81782	0.91-15	9V (6F22)	6/36

- PL Wykrywacz metalu i przewodów
- GB Metal and voltage detector
- D Ortungsgerät für Metal und Leitungen
- RUS Детектор металла и проводки
- CZ Metalo ir átamos detektorius
- RO Detector metale / electricitate
- H Fém- és feszültség detektor
- E Detector de metalu y cables



9V (6F22) BATTERY BATERIA	
	LCD DISPLAY



No.	battery / bateria	
81785	9V (6F22)	20

- PL Pirometr o zmiennej emisyjności
- GB Pirometer with variable emissivity
- D Pirometer mit variabler Emissionsfähigkeit
- RUS Пирометр
- CZ Pyrometr s nastavitelnou emisívitou
- RO Pirometru cu emisivitate variabilă
- H Változó emissziójú pirométer
- E Pirometro de emisividad variable



EMISSIVITY EMISIVNOSC 0.10-1.00	-50+650 °C
BATTERY BATERIA 9V(6F22)	AUTO POWER OFF WYLACZANIE AUTOMATYCZNE
MAX AVG MIN DIFF	
D : S 12 : 1	10 MEASUREMENT MEMORY PAMIĘĆ POMIARU



No.		
81762		5/20

- PL Poziomnica trapezowa
- GB Trapezoidal spirit level
- D Trapezförmige Wasserwaage
- RUS Трапецидальный уровень
- CZ Vodováha trapezova
- RO Nivelă trapezoidală
- H Vizmérték trapéz
- E Trapezoides nivel



No.	L (mm)	vials / libelle	
16280	500	2	50

- PL Wykrywacz metalu i przewodów
- GB Metal and voltage detector
- D Ortungsgerät für Metal und Leitungen
- RUS Детектор металла и проводки
- CZ Metalo ir átamos detektorius
- RO Detector metale / electricitate
- H Fém- és feszültség detektor
- E Detector de metalu y cables



METAL DETECTOR	VOLTAGE DETECTOR



No.	
81781	20

- PL Pirometr mini
- GB Pirometer mini
- D Pirometer Mini
- RUS Пирометр
- CZ Pyrometr mini
- RO Pirometru mini
- H Mini pirométer
- E Minipirometro



EMISSIVITY EMISIVNOSC 0.10-1.00	-30+250 °C
BATTERY BATERIA CR2032 2 x 3V	AUTO POWER OFF WYLACZANIE AUTOMATYCZNE
MAX MIN	
D : S 6 : 1	



No.	
81761	10/40

- PL Higrometr
- GB Hygrometer
- D Hygrometer
- RUS Гигрометр
- CZ Hygrometr
- RO Higrometru
- H Higrométer
- E Higrometro



MAX WASHING STAIN FREE RH%	0-53% SOFTWOOD DREHWOOD MEKKE
0-35% HARDWOOD DREHWOOD TWARDE	20 mm MAX SENSE DEPTH MAX SENSIBILITATE POMIARU
BATTERY BATERIA 9V(6F22)	AUTO POWER OFF WYLACZANIE AUTOMATYCZNE



No.	
81771	5/20

- PL Poziomnica torpeda
- GB Torpedo level
- D Wasserwaage torpedo
- RUS Уровень духа торпедо
- CZ Přesná vodováha torpédo
- RO Nivelă torpilă
- H Vizmérték torpédó
- E Nivel torpedo



230 mm	MAGNETIC	ACCURACY DOKŁADNOŚĆ 0.027" ± 0.5 mm/m
3 PRECISION VIALS LIBELLE		



No.	L (mm)	vials / libelle	
16300	230	3	100

PL Poziomnica torpedo
GB Torpedo level
D Wasserwaage torpedo
RUS Уровень духа торпедо

CZ Přesná vodováha torpédo
RO Nivelă torpilă
H Vizmértek torpédó
E Nivel torpedó

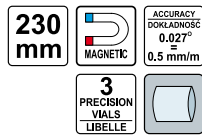

No.	L (mm)	vials / libelle	☐
16301	230	3	100

PL Poziomnica do słupków
GB Post level
D Pfostenwasserwaage
RUS Уровень на должности

CZ Hladiny do míst
RO Niveluri de câtre posturile
H Szinték úzetenete
E Los niveles a los mensajes

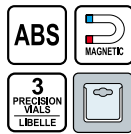

No.	vials / libelle	☐
16012	3	25/100

PL Poziomnica aluminiowa
GB Aluminium level
D Wasserwaage
RUS Уровень

CZ Vodováha
RO Cumpănă
H Vizmértek
E Nivel



No.	L (mm)	vials / libelle	☐
16551	400	3	25/50
16552	600	3	25/50
16553	800	3	25/50
16554	1000	3	25/50
16555	1200	3	15/30
16556	1500	3	15/30
16557	2000	3	10/20

PL Poziomnica laserowa mini
GB Laser level mini
D Laser Wasserwaage mini
RUS Уровни лазерные мини

CZ Úrovně laserové mini
RO Niveluri mini cu laser
H Szinték lézer mini
E Niveles léser mini

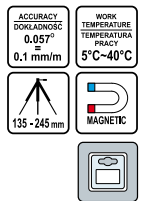

No.	☐
17560	20

PL Poziomnica aluminiowa
GB Aluminium level
D Wasserwaage
RUS Уровень

CZ Vodováha
RO Cumpănă
H Vizmértek
E Nivel



No.	L (mm)	vials / libelle	☐
16340	400	3	20/60
16360	600	3	20/60
16380	800	3	20/60
16400	1000	3	20/60

PL Poziomnica aluminiowa
GB Aluminium level
D Wasserwaage
RUS Уровень

CZ Vodováha
RO Cumpănă
H Vizmértek
E Nivel



No.	L (mm)	vials / libelle	☐
17606	600	3	20/60
17608	800	3	20/60
17610	1000	3	20/60
17612	1200	3	15/30
17615	1500	3	15/30
17620	2000	3	10/20

PL Poziomnica wodna z wężem
GB Water level
D Schlauchwaage
RUS Гидроуровень

CZ Vodná vodováha
RO Furtun de nivel
H Vizes vizmértek
E Nivel de agua



No.	L (m)	size / rozmiar (mm)	☐
16000	15	10	15
16001	20	10	15
16002	25	10	15

13

Pneumatic tools Narzędzia pneumatyczne



Air tools
Narzędzia pneumatyczne

176-178



Impact wrenches Klucze udarowe.....	176
Pneumatic grinders Szlifierki pneumatyczne.....	176
Pneumatic ratchets Grzechotki pneumatyczne.....	177
Ratchet air wrenches Klucze pneumatyczne.....	177
Pneumatic hammers Młotki pneumatyczne.....	177

Tire inflating guns & heads
Pistolety do pompowania kół
i głowice

178

Pneumatic painting equipment
Narzędzia do malowania

178-183



Spray guns Pistolety lakiernicze.....	178
Blow guns Pistolety do przedmuchiwania.....	179
Washing guns Pistolety do ropowania.....	180
Pneumatic painting equipment GAV Narzędzia do malowania GAV.....	180

Pneumatic accessories
Akcesoria instalacji
pneumatycznej

184-185



Air filters, regulators & lubricators Filtry, reduktory i smarownice.....	184
Spiral hoses Węże spiralne.....	184
Reinforced hoses Węże zbrojone.....	184
Couplers Złącza.....	185

- PL Klucz pneumatyczny udarowy
- GB Impact wrench
- D Druckluft-Schlagschrauber
- RUS Гайковерт пневматический
- CZ Klíč pneumatický
- RO Pistol pneumatic
- H Pneumatikus ütvecsavarozó
- E Llave de percusión



STANDARD **226** l/min

0-7000 min⁻¹ **0.63** MPa_(max.)

1/2" (12.5mm) **340** Nm



$L_{pA} = 84,4 \text{ dB}; L_{wA} = 95,4 \text{ dB}; a_n = 2,6 \pm 2,0 \text{ m/s}^2$

No.	size / rozmiar	l / min	Nm	
81100	1/2" (12.5 mm)	226	340	10

- PL Szlifierka pneumatyczna prosta
- GB Air grinder
- D Drucklufteinhandschleifer
- RUS Прямая пневматическая шлифмашинка
- CZ Bruska přímá pneumatická
- RO Polizor pneumatic
- H Préslevegős sarokcsiszoló
- E Lijadera neumática recta

0.63 MPa_(max.)

25000 min⁻¹

100 l/min

STANDARD

Ø6mm



$L_{pA} = 88,0 \pm 3,0 \text{ dB}; L_{wA} = 99,0 \pm 3,0 \text{ dB}; a_n = 2,9 \pm 1,5 \text{ m/s}^2$

No.	size / rozmiar	l / min	min-1	
81107	1/4" (6.3 mm)	100	25000	20

- PL Szlifierka pneumatyczna kątowa
- GB Air angle grinder
- D Druckluft-Winkelschleifer
- RUS Угловая шлифовальная машинка
- CZ Bruska úhlová vzduchová
- RO Polizor pneumatic
- H Préslevegős sarokcsiszoló
- E Lijadera neumática de ángulo

STANDARD **113** l/min

0-20000 min⁻¹ **0.63** MPa_(max.)

Ø6mm



$L_{pA} = 90,1 \text{ dB}; L_{wA} = 101,1 \text{ dB}; a_n = 0,7 \text{ m/s}^2$

No.	size / rozmiar	l / min	min-1	
81110	1/4" (6.3 mm)	113	20000	16

- PL Klucz pneumatyczny z nasadkami
- GB Air impact kit
- D Druckluft-Schlagschrauber mit Krafeinsätzen
- RUS Гайковерт пневматический + набор головок
- CZ Klíč pneumatický s nástavci
- RO Pistol pneumatic cu accesorii
- H Pneumatikus ütvecsavarozó készlet
- E Llave neumático de percusión



9 10 11 13 14 17
19 22 24 27 mm

0.63 MPa_(max.)

0-7000 min⁻¹

340 Nm

1/2" (12.5 mm)

STANDARD

226 l/min

CrV

MINI OILER OIL POT



$L_{pA} = 84,4 \text{ dB}; L_{wA} = 95,4 \text{ dB}; a_n = 2,6 \pm 2,0 \text{ m/s}^2$

No.	size / rozmiar	l / min	Nm	
81101	1/2" (12.5 mm)	226	340	5

- PL Szlifierka pneumatyczna prosta
- GB Air grinder
- D Drucklufteinhandschleifer
- RUS Прямая пневматическая шлифмашинка
- CZ Bruska přímá pneumatická
- RO Polizor pneumatic
- H Préslevegős sarokcsiszoló
- E Lijadera neumática recta

0.63 MPa_(max.)

0-22000 min⁻¹

198 l/min

STANDARD

Ø6mm



$L_{pA} = 83,5 \text{ dB}; L_{wA} = 94,5 \text{ dB}; a_n = 1,2 \pm 2,0 \text{ m/s}^2$

No.	size / rozmiar	l / min	min-1	
81108	1/4" (6.3 mm)	198	22000	20

- PL Szlifierka pneumatyczna prosta z akcesoriami
- GB Die grinder kit
- D Druckluft-Schrauber mit Schleifaufsätzen
- RUS Прямая пневматическая шлифмашинка + принадлежности
- CZ Bruska přímá pneumatická s příslušenstvím
- RO Masina de polizat pneumatică
- H Pneumatikus köszörű készlet
- E Lijadora neumática recta

0.63 MPa_(max.)

0-22000 min⁻¹

127 l/min

STANDARD

Ø3;6mm

10 pcs



$L_{pA} = 83,5 \text{ dB}; L_{wA} = 94,5 \text{ dB}; a_n = 1,2 \pm 2,0 \text{ m/s}^2$

No.	size / rozmiar	l / min	min-1	
81109	1/4" (6.3 mm)	127	22000	8

- PL Zestaw pneumatyczny szlifierka mini
- GB Air micro die grinder kit
- D Luft Sterben Schleifer Kit
- RUS Пневмошлифмашина мини в наборе
- CZ Pneumatická bruska mini
- RO Biax pneumatic tip stilou
- H Pneumatikus mini-csiszoló
- E Amoladora biax recta neumática



$L_{pa} = 79 \pm 3$ dB; $L_{wa} = 90 \pm 3$ dB; $a_n = < 2,5$ m/s²

No.	size / rozmiar	Ø (mm)	min-1	
80970	1/4" (6.3 mm)	3	0-54000	10

- PL Tarcza polerska do szlifierki pneumatycznej
- GB Disc for air sander
- D Stützteller für Druckluftexcenterschleifer
- RUS Диск для эксцентриковой шлифмашины
- CZ Disk pro pneumatickou brusku
- RO Masina disc pt. slefuit
- H Csiszolókorong pneumatikus gépekhez
- E Recambio disco lijadora orbital neumática



No.	Ø (mm)	min-1	
81115	150	0-10000	10/100

- PL Grzechotka pneumatyczna
- GB Ratchet air wrench
- D Druckluft-Ratschenschrauber
- RUS Пневмотрещотка
- CZ Utahovák vzduchový
- RO Antrenor pneumatic
- H Préslevegős behajtó szerszám
- E Carraca neumática

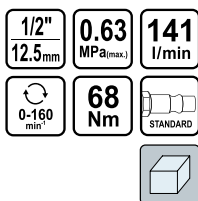

No.	size / rozmiar	l / min	Nm	
81118	1/2" (12.5 mm)	141	68	10

- PL Szlifierka pneumatyczna mimośrodowa
- GB Air sander
- D Druckluft- Excenterschleifer
- RUS Эксцентриковая шлифмашина
- CZ Bruska pneumatická
- RO Masina de slefuit pneumatica
- H Pneumatikus sarokcsiszológép
- E Lijadera neumática excentrica



$L_{pa} = 72,7$ dB; $L_{wa} = 83,7$ dB; $a_n = 1,44$ m/s²

No.	size / rozmiar	Ø (mm)	MPa	
81114	1/4" (6.3 mm)	150	0.63	10

- PL Grzechotka pneumatyczna
- GB Ratchet air wrench
- D Druckluft-Ratschenschrauber
- RUS Пневматический гаечный ключ с трещоткой
- CZ Utahovák vzduchový
- RO Antrenor pneumatic
- H Préslevegős behajtó szerszám
- E Carraca neumática

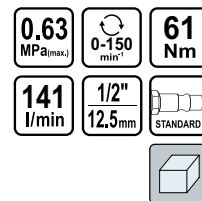

$L_pA = 90,8$ dB; $L_wA = 101,8$ dB; $a_n = 1,2 \pm 2,0$ m/s²

No.	size / rozmiar	l / min	Nm	
81117	1/2" (12.5 mm)	141	61	20

- PL Klucz pneumatyczny kątowy
- GB Ratchet air wrench
- D Druckluft-Ratschenschrauber
- RUS Пневматический гаечный ключ с храповиком
- CZ Utahovák vzduchový
- RO Antrenor pneumatic
- H Préslevegős behajtó szerszám
- E Llave neumático de ángulo con carraca

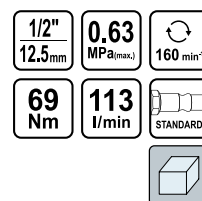

$L_{pa} = 94,0 \pm 3,0$ dB; $L_{wa} = 105,0 \pm 3,0$ dB; $a_n = 9,0 \pm 1,5$ m/s²

No.	size / rozmiar	l / min	min-1	
81119	1/2" (12.5 mm)	113	160	10

- PL Młotek pneumatyczny CZ Sekáč vzduchový
 GB Air hammer RO Pneumatikus vészkészlet pisztollyal
 D Druckluft-Schlaghammer H Klavido pneumatické
 RUS Пневматический молоток E Marteau burineur



VOREL

No.	size / rozmiar	l / min	
81133	1/4" (6.3 mm)	113	8

- PL Pistolet do pompowania z manometrem
 GB Tire-inflating gun
 D Reifenfüller mit Manometer
 RUS Пистолет для накачки шин с манометром
 CZ Pistoľe na čerpání z manometrom
 RO Pistol de aer pt. pneuri cu manometru
 H Nyomásmérő tehergépkocsikhoz
 E Pistola de bombeo con manometro



VOREL

No.	size / rozmiar	l / min	
81650			10/40

- PL Glowica do pompowania
 GB Inflating head
 D Klemmnippel (universal)
 RUS Насадка на насос под шланг
 CZ Hlava na čerpání
 RO Cap pt. pompat
 H Pumpafej
 E Cabeza de bombeo



VOREL

No.	mm	
81653	8	50/300
81661	6	50/300

- PL Pistolet natryskowy
 GB Spray gun with fluid cup
 D Lackierpistole mit Fließbecher
 RUS Краскораспылитель верхний бак
 CZ Pistoľe na lakování z nádrží
 RO Pistol de vopsit cu rezervor inferior
 H Festőpisztoly alsó tartállyal
 E Pistola de barniz



VOREL

No.	Ø (mm)	
80902	1.4	10

L_{pa} = 58,2 dB; L_{wa} = 69,2 dB

- PL Zestaw narzędzi pneumatycznych z akcesoriami
 GB Pneumatic tool set
 D Druckluftwerkzeugsatz mit Zubehör
 RUS Пневматический ударный инструмент в наборе
 CZ Sada pneumatického nářadí
 RO Set pistol + accesorii pneumatice
 H Légszersámok készlet
 E Juego de herramientas neumáticas con accesorios



VOREL

No.	size / rozmiar	Ø (mm)	pcs	
81142	1/2" (12.5 mm)	6	33	2

- PL Pistolet natryskowy
 GB Spray gun with fluid cup
 D Lackierpistole mit Fließbecher
 RUS Краскораспылитель нижний металлический бачок
 CZ Pistoľe na lakování z nádrží
 RO Pistol de vopsit cu rezervor inferior
 H Festőpisztoly alsó tartállyal
 E Pistola de barniz



VOREL

No.	Ø (mm)	
80901	1.4	10

L_{pa} = 61,2 dB; L_{wa} = 72,2 dB

- PL Pistolet natryskowy
 GB Spray gun with fluid cup
 D Lackierpistole mit Fließbecher
 RUS Краскораспылитель нижний металлический бачок
 CZ Pistoľe na lakování z nádrží
 RO Pistol de vopsit cu rezervor inferior
 H Festőpisztoly alsó tartállyal
 E Pistola de barniz



VOREL

No.	Ø (mm)	
81617	1.5	20

- PL Pistolet natryskowy
- GB Spray gun with fluid cup
- D Lackierpistole mit Fliessbecher
- RUS Краскораспылитель верхний бак
- CZ Pistole na lakování z nádrží
- RO Pistol de vopsit cu rezervor inferior
- H Festőpisztoly alsó tartállyal
- E Pistola de barniz



0.4 MPa	0.68l
1.5mm	450 l/min



No.	Ø (mm)	
81618	1.5	20

- PL Zestaw lakierniczy
- GB Spray gun kit
- D Lackierspritzsatz
- RUS Набор покрасочный пневматический
- CZ Laková souprava
- RO Set de lacuit
- H Részes fényezőkészlet
- E Juego de barniz

5
PCS



- PL Zestaw lakierniczy
- GB Spray gun kit
- D Lackierspritzsatz
- RUS Набор покрасочный пневматический
- CZ Laková souprava
- RO Set de lacuit
- H Részes fényezőkészlet
- E Juego de barniz

5
PCS



3-6 bar, L=400 mm	3-5 bar, 950ml
3-5 bar	3,5-5bar, 750ml, ø1,5mm, 280-450 l/min
L=5m	



No.	pcs	
81637	5	10

- PL Pistolet do przedmuchiwania
- GB Blow gun
- D Ausblaspistole
- RUS Пистолет для продувки короткий
- CZ Pistole na profukování krátká
- RO Pistol scurt pt. suflat
- H Pövid előlefvő pisztoly
- E Pistola de soplado

4mm	1.2-3bar

13



No.	
81640	20/40

3-6 bar, L=400 mm	3-5 bar, 950ml
3-5 bar	3,5-5bar, 750ml, ø1,5mm, 280-450 l/min
L=5m	



No.	pcs	
81638	5	10

- PL Pistolet do przedmuchiwania z przedłużką
- GB Blow gun with extension
- D Gebläsepistole mit Verlängerung
- RUS Пистолет для продувки длинный
- CZ Pistole na profukování dlouhá
- RO Pistol lung pt. suflat
- H Rövid előlefvő pisztoly
- E Pistola de soplado

4 mm
0.8 MPa



No.	
81644	20/40

- PL Zestaw do przedmuchiwania
- GB Air blow gun kit
- D Ausblaspistole Druckluft Set
- RUS Набор для продувки
- CZ Pneumatická čistící pistole sada
- RO Pistol aer curatat praful cu furtun
- H Fuvató pisztoly szett
- E Kit pistola de aire aire bobina

3
PCS
PE



No.	
81634	10/20

$L_{pA} = 90 \text{ dB}; L_{wA} = 101 \text{ dB}; a_w = < 2.5 \text{ m/s}^2$

- PL Pistolet do ropowania
 GB Washing gun
 D Waschpistole
 RUS Пистолет для нефтявания
- CZ Pistole na ropování
 RO Pistol (dozator) pt. motorină
 H Olajzöpisztoly
 E Pistola de petrolar

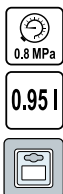

No.			
81647			10/20

- PL Pistolet natryskowy
 GB Spray gun with fluid cup
 D Lackierpistole mit Fliessbecher
 RUS Краскораспылитель верхний бак
 CZ Pistole na lakování z nádrží
 RO Pistol de vopsit cu rezervor inferior
 H Festőpisztoly alsó tartállyal
 E Pistola de barniz



No.	cm³	bar	
GV-0062	750	4-8	20

- PL Pistolet do przedmuchiwania
 GB Blow gun with extension
 D Gebläsepistole mit Verlängerung
 RUS Пистолет для продувки (короткий)
- CZ Pistole na profukování dlouhá
 RO Pistol lung pt. suflat
 H Rövid előfúvó pisztoly
 E Pistola de soplado



No.	bar	
GV-0400	12	100

- PL Pistolet do ropowania
 GB Washing gun
 D Waschpistole
 RUS Пистолет для нефтявания
- CZ Pistole na ropování
 RO Pistol (dozator) pt. motorină
 H Olajzöpisztoly
 E Pistola de petrolar



No.	bar	
GV-0510	12	18

- PL Pistolet natryskowy
 GB Spray gun with fluid cup
 D Lackierpistole mit Fliessbecher
 RUS Краскораспылитель верхний бак
 CZ Pistole na lakování z nádrží
 RO Pistol de vopsit cu rezervor inferior
 H Festőpisztoly alsó tartállyal
 E Pistola de barniz



No.	cm³	bar	
GV-0083	1000	4-8	20

- PL Pistolet natryskowy
 GB Spray gun with fluid cup
 D Lackierpistole mit Fliessbecher
 RUS Краскораспылитель нижний металлический бачок
 CZ Pistole na lakování z nádrží
 RO Pistol de vopsit cu rezervor inferior
 H Festőpisztoly alsó tartállyal
 E Pistola de barniz



No.	cm³	bar	
GV-0082	1000	4-8	20

- PL Pistolet do przedmuchiwania
 GB Blow gun with extension
 D Gebläsepistole mit Verlängerung
 RUS Пистолет для продувки длинный
- CZ Pistole na profukování dlouhá
 RO Pistol lung pt. suflat
 H Rövid előfúvó pisztoly
 E Pistola de soplado



No.	bar	
GV-0420	12	200

- PL Pistolet do pompowania z manometrem
 GB Tire-inflating gun
 D Reifenfüller Manometer
 RUS Пистолет для накачки шин с манометром
- CZ Pistole na čerpání z manometrem
 RO Pistol presiune cu manometru
 H Indicator depresiune pt. camioane
 E Pistola de bombeo con manometro



No.	bar	
GV-0610	12	100

- PL Pistolet do pompowania z manometrem CZ Pistolet na čerpání z manometrem
 GB Tire-inflating gun RO Pistol presiune cu manometru
 D Reifenfüller Manometer H Indicator depresiune pt. camioane
 RUS Пистолет для накачки шин с манометром E Pistola de bombeo con manometro



No.	bar	
GV-0620	10	100

- PL Głowica do pompowania CZ Hlava na čerpání
 GB Universal head RO Cap pt. pompat
 D Klemmnippel (universal) H Pumpafej
 RUS Насадка на насос под шланг E Cabeza de bombeo



No.	Ø (mm)	
GV-0656	6	500/1500
GV-0658	8	250/1000

- PL Pistolet do piaskowania z węzłem CZ Piskovací pistole s hadicí
 GB Air sand blaster RO Pistol de sablat
 D Pistole zum sandstrahlen H Homokszóró pisztoly tömlővel
 RUS Пескоструйный пистолет E Pistola para limpieza con chorro de arena con manguera



No.	bar	m	
GV-0710	6-8	2	50

- PL Pistolet do konserwacji CZ Konzervační pistole
 GB Gun for protection and sound-roofing treatments RO Pistol pt. întreținere
 D Spitzpistole für Flächenschutzfluide H Karbantartó pisztoly
 RUS Пистолет для консервирования E Pistola de conservar sin recipiente



No.	bar	
GV-0730	6-8	100

- PL Pistolet do pompowania z manometrem CZ Pistolet na čerpání z manometrem
 GB Tire-inflating gun RO Pistol presiune cu manometru
 D Reifenfüller Manometer H Indicator depresiune pt. camioane
 RUS Пистолет для накачки шин с манометром E Pistola de bombeo con manometro



No.	bar	
GV-0631	12	25

- PL Pistolet do piaskowania ze zbiornikiem CZ Piskovací pistole se zásobníkem
 GB Gun suitable for sand-blasting RO Pistol de sablat
 D Sandstrahlpistole H Homokszóró pisztoly tartállyal
 RUS Пескоструйный пистолет E Pistola para limpieza con chorro de arena con recip.



No.	cm³	bar	
GV-0700	1000	6-8	100

- PL Pistolet do konserwacji CZ Konzervační pistole
 GB Gun for sound-deadening treatments RO Pistol pt. întreținere
 D Spitzpistole für Flächenschutzfluide H Karbantartó pisztoly
 RUS Пистолет для консервирования E Pistola de conservar con recipiente



No.	cm³	bar	
GV-0720	1000	6-8	100

- PL Pistolet do konserwacji z węzłem CZ Konzervační pistole s hadicí
 GB Gun for protection and sound-roofing treatments RO Pistol pt. întreținere, cu furtun
 D Spitzpistole für Flächenschutzfluide H Karbantartó pisztoly tömlővel
 RUS Пистолет для консервирования E Pistola de conservar sin recipiente con manguera



No.	bar	
GV-0740	6-8	75

- PL Filtr - reduktor
 GB Filter - reducer
 D Druckfilter - Druckminderer
 RUS Фильтр - редуктор
- CZ Filtr derukční ventil
 RO Filtru cu reduktor
 H Szűrő - nyomásszabályzó
 E Reductor + filtro



No.	max bar	size / rozmiar	
GV-0861	16	1/2" (12.5 mm)	20

- PL Reductor ciśnienia z manometrem
 GB Pressure reducing valve with manometer
 D Druckminderer mit Manometer
 RUS Регулятор давления с манометром
- CZ Redukční ventil s manometrem
 RO Valva cu reductiepresiune + manometru
 H Nyomáscsökkentő szelep nyomásmérővel
 E Reductor + manometro



No.	max bar	
GV-0925	12	100

13

- PL Szybkozłącze
 GB Quick coupler
 D Schnellkupplung
 RUS Быстроразъемное соединение на шланг
- CZ Rychlospojka
 RO Mufa rapida pt. pistol pneumatic
 H Gyorscsatlakozó
 E Conexión de la entrada de aire



No.	Ø (mm)	
GV-1121	6	100/300
GV-1122	8	100/300
GV-1123	10	100/300

- PL Szybkozłącze
 GB Quick coupler
 D Schnellkupplung
 RUS Быстроразъемная муфта с наружной резьбой
- CZ Rychlospojka
 RO Mufa rapida pt. pistol pneumatic
 H Gyorscsatlakozó
 E Conexión de la entrada de aire



No.	size / rozmiar	
GV-1150	1/4" (6.3 mm)	100/400
GV-1151	3/8" (10.0 mm)	100/400
GV-1152	1/2" (12.5 mm)	100/400

- PL Zespół filtrujący, reduktor + smarownica
 GB Air filter regulator and lubricator
 D Druckfilter-Druckminderer - Entöler
 RUS Фильтр-редуктор + смазочный прибор
- CZ Redukční ventil s odlučovačem oleje
 RO Filtru cu reduktor
 H Levegőelőkészítő
 E Juego de filtro reductor + engrasador



No.	max bar	size / rozmiar	
GV-0871	16	1/2" (12.5 mm)	18

- PL Szybkozłącze
 GB Quick coupler
 D Schnellkupplung
 RUS Быстроразъемная муфта с наружной резьбой
- CZ Rychlospojka
 RO Mufa rapida pt. pistol pneumatic
 H Gyorscsatlakozó
 E Conexión de la entrada de aire



No.	size / rozmiar (M)	
GV-1100	1/4" (6.3 mm)	100/300
GV-1101	3/8" (10.0 mm)	100/300
GV-1102	1/2" (12.5 mm)	100/300

- PL Szybkozłącze
 GB Quick coupler
 D Schnellkupplung
 RUS Быстроразъемное соединение с внутренней резьбой
- CZ Rychlospojka
 RO Mufa rapida pt. pistol pneumatic
 H Gyorscsatlakozó
 E Conexión de la entrada de aire



No.	size / rozmiar (F)	
GV-1105	1/4" (6.3 mm)	100/300

- PL Szybkozłącze
 GB Quick coupler
 D Schnellkupplung
 RUS Быстроразъемное соединение с внутренней резьбой
- CZ Rychlospojka
 RO Mufa rapida pt. pistol pneumatic
 H Gyorscsatlakozó
 E Conexión de la entrada de aire



No.	size / rozmiar	
GV-1160	1/4" (6.3 mm)	100/400
GV-1161	3/8" (10.0 mm)	100/400

- PL Szybkozłącze
GB Quick coupler
D Schnellkupplung
RUS Быстроразъемное соединение на шланг
- CZ Rychlospojka
RO Mufa rapida pt. pistol pneumatic
H Gyorscsatlakozó
E Conexión de la entrada de aire



No.	Ø (mm)	
GV-1180	6	100/400
GV-1181	8	100/400
GV-1182	10	100/400

- PL Szybkozłącze
GB Quick coupler
D Schnellkupplung
RUS Быстроразъемное соединение (штуцер), внутренняя резьба
- CZ Rychlospojka
RO Mufa rapida pt. pistol pneumatic
H Gyorscsatlakozó
E Conexión de la entrada de aire



No.	size / rozmiar	
GV-1220	1/4" (6.3 mm)	500/1000
GV-1221	3/8" (10.0 mm)	500/1000

- PL Gwint stożkowy
GB Taper reducer
D Verlängerungsrippel
RUS Нипель 1/4"-1/4"
- CZ Vsvuka s kuželovým závitem
RO Reducție
H Kúpos menet
E Junta nypel rosca cónica



No.	size / rozmiar	
GV-1272	1/4" (6.3 mm)	100/2000

- PL Złącze króciec do węża
GB Male hose adapter
D Schauchtülle mit Aussengewinde
RUS Штуцер „елочка” с наружной резьбой
- CZ Spojky – nátrubek pro hadici
RO Adaptor furtun
H Csatlakozó csőcsonk tömlőhöz
E Junta tubo corto para manguera 6 rosca exter



No.	size / rozmiar	Ø (mm)	L (mm)	
GV-1382	1/4" (6.3 mm)	6	33	500/1500
GV-1384	1/4" (6.3 mm)	8	33	600
GV-1385	3/8" (10.0 mm)	8	34	100/1000
GV-1386	3/8" (10.0 mm)	10	34	100/1200
GV-1387	1/2" (12.5 mm)	10	37	250/1000
GV-1388	1/4" (6.3 mm)	10	35	500

- PL Szybkozłącze
GB Quick coupler
D Schnellkupplung
RUS Быстроразъемное соединение с наружной резьбой
- CZ Rychlospojka
RO Mufa rapida pt. pistol pneumatic
H Gyorscsatlakozó
E Conexión de la entrada de aire



No.	size / rozmiar	
GV-1200	1/4" (6.3 mm)	500/2000
GV-1201	3/8" (10.0 mm)	500/1000
GV-1202	1/2" (12.5 mm)	250/1000

- PL Szybkozłącze
GB Quick coupler
D Schnellkupplung
RUS Быстроразъемное соединение (штуцер), „елочка” с обжимным кольцом
- CZ Rychlospojka
RO Mufa rapida pt. pistol pneumatic
H Gyorscsatlakozó
E Conexión de la entrada de aire



No.	Ø (mm)	
GV-1240	6	500/1500
GV-1241	8	500/2000
GV-1242	10	500/1500

- PL Złącze bagnetowe do węży
GB Bayonet coupling for rubber pipes
D Bajonettverschluss für gummschläuche
RUS Переходник „елочка на елочку”
- CZ Spojky hadicové bajonetové
RO Conector tevi
H Bajonett csatlakozó tömlőhöz
E Junta de bayoneta para manguera de goma



No.	Ø (mm)	
GV-1582	8	100/800
GV-1583	10	600



PL Filtr
GB Filter
D Filtr
RUS Фильтр воздушный мини

CZ Filtr
RO Minifiltru
H Szűrő
E Filtro

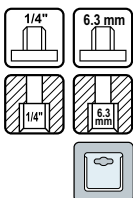

No.	size / rozmiar	
81560	1/4" (6.3 mm)	10/50

PL Filtr - reduktor
GB Filter - reducer
D Druckfilter - Druckminderer
RUS Фильтр - редуктор

CZ Filtr derukční ventil
RO Filtru cu reductor
H Szűrő - nyomásszabályzó
E Reductor + filtro



No.	size / rozmiar	
81553	1/2" (12.5 mm)	20

PL Waż spiralny PE z szybkozłączami
GB PE spiral tubes with rapid couplings
D Spiralschlauch mit Schnellkupplung
RUS Шланг спиральный с быстроразъемным соединением

CZ Spirální hadice
RO Furtun în spirală
H Spiráltömlő
E Manguera espiral



No.	mm	L (m)	
81490	5x8	5	50
81491	5x8	10	25
81492	5x8	15	25

PL Waż zbrojony
GB Armoured hose
D Schlauch, verstärkt durch Bewehrung
RUS Шланг армированный для подачи воздуха

CZ Hadice vyztužená
RO Furtun armat
H Fémбетétes tömlő
E Manguera armada

No.	Ø (mm)	L (m)	wall thickness / grubość ścianki	ATM	
81519	6	50	2.5	10/40	1
81520	8	50	2.5	10/40	1
81521	10	50	2.5	10/40	1
81522	12	50	2.5	10/40	1
81523	14	50	3.0	10/40	1
81524	16	50	3.0	10/40	1
81525	19	50	3.5	10/40	1
81527	25	50	4.0	10/40	1

PL Reduktor ciśnienia z manometrem
GB Pressure reducing valve with manometer
D Druckminderer mit Manometer
RUS Регулятор давления с манометром

CZ Redukční ventil s manometrem
RO Valva cu reductiepresiune + manometru
H Nyomáscsökkentő szelep nyomásmérővel
E Reductor + manometro



No.	size / rozmiar	
81562	3/8" (10.0 mm)	50

PL Zespół filtrujący, reduktor + smarownica
GB Air filter regulator and lubricator
D Druckfilter-Druckminderer - Entöler
RUS Фильтр-редуктор + смазочный прибор

CZ Redukční ventil s odlučovačem oleje
RO Filtru cu reductor
H Levégőelőkészítő
E Juego de filtro reductor + engrasador

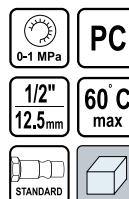

No.	size / rozmiar	
81556	1/2" (12.5 mm)	20

PL Waż spiralny PU z szybkozłączami
GB PU spiral tubes with rapid couplings
D Spiralschlauch mit Schnellkupplung
RUS Шланг спиральный с быстроразъемным соединением

CZ Spirální hadice
RO Furtun în spirală
H Spiráltömlő
E Manguera espiral



No.	mm	L (m)	
81500	5x8	5	50
81501	5x8	10	25
81502	5x8	15	25



PL Szybkozłącze
GB Quick coupler
D Schnellkupplung
RUS Быстроразъемная муфта с наружной резьбой

CZ Rychlospojka
RO Mufa rapida pt. pistol pneumatic
H Gyorscsatlakozó
E Conexión de la entrada de aire



No.	type	size / rozmiar	
81370	D	1/4" (6.3 mm)	50/250
81371	D	3/8" (10.0 mm)	50/250
81372	D	1/2" (12.5 mm)	50/250

PL Szybkozłącze
GB Quick coupler
D Schnellkupplung
RUS Быстроразъемное соединение на шланг

CZ Rychlospojka
RO Mufa rapida pt. pistol pneumatic
H Gyorscsatlakozó
E Conexión de la entrada de aire



No.	type	size / rozmiar	
81378	D	1/4" (6.3 mm)	50/250
81379	D	3/8" (10.0 mm)	50/250
81380	D	1/2" (12.5 mm)	50/250

PL Szybkozłącze
GB Quick coupler
D Schnellkupplung
RUS Быстроразъемное соединение с наружной резьбой

CZ Rychlospojka
RO Mufa rapida pt. pistol pneumatic
H Gyorscsatlakozó
E Conexión de la entrada de aire



No.	type	size / rozmiar	
81387	D	1/4" (6.3 mm)	50/250

PL Szybkozłącze
GB Quick coupler
D Schnellkupplung
RUS Быстроразъемное соединение с внутренней резьбой

CZ Rychlospojka
RO Mufa rapida pt. pistol pneumatic
H Gyorscsatlakozó
E Conexión de la entrada de aire



No.	type	size / rozmiar	
81373	D	1/4" (6.3 mm)	50/250
81374	D	3/8" (10.0 mm)	50/250

PL Szybkozłącze
GB Quick coupler
D Schnellkupplung
RUS Быстроразъемное соединение (штуцер), внутренняя резьба

CZ Rychlospojka
RO Mufa rapida pt. pistol pneumatic
H Gyorscsatlakozó
E Conexión de la entrada de aire



No.	type	size / rozmiar	
81390	D	1/4" (6.3 mm)	50/250
81391	D	3/8" (10.0 mm)	50/250

PL Szybkozłącze
GB Quick coupler
D Schnellkupplung
RUS Быстроразъемное соединение (штуцер), «ёлочка» с обжимным кольцом

CZ Rychlospojka
RO Mufa rapida pt. pistol pneumatic
H Gyorscsatlakozó
E Conexión de la entrada de aire



No.	type	size / rozmiar	
81399	D	1/4" (6.3 mm)	50/250
81400	D	3/8" (10.0 mm)	10/100
81401	D	1/2" (12.5 mm)	50/250

13

Memo

14

Special automotive tools & equipment Narzędzia i wyposażenie warsztatu samochodowego



Cabinets Szafki



188-189

Roller cabinets with tools insert

Szafki serwisowe z narzędziami..... 188

Tool cabinets

Szafki serwisowe..... 189

Lubrication tools Narzędzia do smarowania



189-192

Grease guns & oil transfer pumps

Smarownice ręczne i pompy transferowe do oleju..... 189

Manual oil pumps

Pompy ręczne do oleju..... 190

Oil cans

Oliwiarki..... 191

Oil filter wrenches

Klucze do filtra oleju..... 191

Pullers Ściągacze

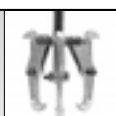

192-193

Gear pullers

Ściągacze do łożysk..... 192

Spring pullers

Ściągacze do sprężyn..... 192

Ball joint removers

Ściągacze do sworzni kulistych..... 193

Workshop tools Narzędzia warsztatowe



193-202

Wheel wrenches

Klucze do kół..... 193

Piston ring compressors

Zaciskacze do pierścieni..... 194

Spark plug sockets

Klucze do świec..... 194

Flare nut wrenches

Klucze do przewodów hamulcowych..... 194

Car voltage testers

Samochodowe próbniki napięcia..... 194

Magnetic pick up tools

Chwytyki magnetyczne..... 194

Workshop seats

Taborety warsztatowe..... 195

Workshop creepers

Leżanki warsztatowe..... 195

Impact wrenches

Klucze udarowe..... 195

Workshop lamps

Lampy warsztatowe..... 196

Bottle & floor jacks

Dźwigniki słupkowe i podnośniki..... 199

Scissors jacks

Podnośniki mechaniczne..... 200

Jack stands

Podstawki pod samochód..... 200

Porta power kits

Rozpierzaki hydrauliczne..... 201

Pull-back rams

Ściągacze blacharskie hydrauliczne..... 201

Battery chargers

Prostowniki..... 201

Tire pressure gauges

Mierniki ciśnienia..... 202

Chain blocks

Wciągarki łańcuchowe..... 202

Car accessories Akcesoria samochodowe



202-209

Pumps

Pompy..... 202

Tow ropes

Linki holownicze..... 203

Battery clamp cleaners

Szczotki do czyszczenia klem..... 204

Battery hydrometers

Próbniki akumulatorowe..... 205

Booster cables

Wiązki przewodów awaryjnych..... 205

Scrapers & brushes

Skrabaczki i szczotki..... 205

Flexible funnels

Lejki..... 205

Car vacuum cleaners

Odkurzacze samochodowe..... 206

Fire extinguishers

Gaśnice samochodowe..... 206

First aid kits

Apteczki..... 206

Safety triangles

Trójkąty ostrzegawcze..... 207

Ratchet tie downs

Taśmy do bagażu..... 207

Tarpaulins

Plandeki..... 209

PL Szafka serwisowa z narzędziami
 GB Service tool cabinet with tools
 D Serviceschrank mit Werkzeugen
 RUS Сервисный шкаф с инструментами
 CZ Servisní skříňka s nářadím
 RO Cutie de service cu scule
 H Szervizszekrény szerszámokkal
 E Armario para herramientas de servicio

177 PCS TRAYS WPKŁAD
 12x 901x770x458mm
 6x WHEELS
 2x BRAKE HAMULCE
 BALL BEARING LOŻYSKA KULKOWE
 NON SLIP WORKTOP BLAT ANTYPŁOSKOWY
 DRAWERS LOCKING BLOKADA SZUFLAD
 CENTRAL LOCK CENTRALNY ZAMEK
 2x1
 CORNER BUMPERS NARÓŻNE ODBOJNIKI
 UNIVERSAL PERFORATION UNIWERSALNA PERFORACJA



14

12 interchangeable trays with tools
 12 wymiennych modułów z narzędziami

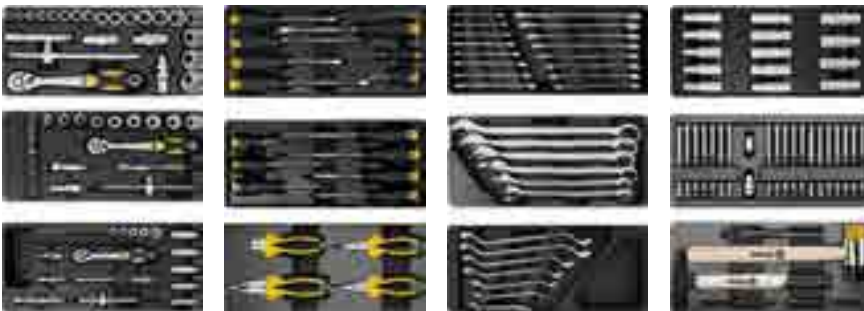

DRAWER / SZUFLADA 1

1/2" (12.7 mm): 10, 11, 12, 13, 14, 15, 16, 17, 18, 19, 20, 21, 22, 23, 24, 27, 30, 32 mm; CrV 50BV30; 1/2" (12.7 mm); (127 mm); CrV 50BV30; 1/2" (12.7 mm); CrV 50BV30; 1/2" (12.7 mm); (255 mm); 72T; CrV 6140; 1/2" (12.7 mm); (255 mm); CrV 50BV30; 1/2" (12.7 mm); 16; 21 mm; CrV 50BV30

3/8" (9.5 mm): 6, 7, 8, 9, 10, 11, 12, 13, 14, 15, 16, 17, 18, 19, 20, 21, 22 mm; CrV 50BV30; 3/8" (9.5 mm); (76, 152.4 mm); CrV 50BV30; 3/8" (9.5 mm); CrV 50BV30; 3/8" (9.5 mm); (200 mm); 72T; CrV 6140; 3/8" (9.5 mm); (198 mm); CrV 50BV30

1/4" (6.3 mm): 3.5, 4, 4.5, 5, 5.5, 6, 7, 8, 9, 10, 11, 12, 13, 14 mm; CrV 50BV30; 1/4" (6.3 mm); 8, 10, 11, 12, 13 mm; CrV 50BV30; 1/4" (6.3 mm); (50.8, 101.6 mm); CrV 6140; 1/4" (6.3 mm); CrV 50BV30; 1/4" (6.3 mm); (155 mm); 72T; CrV 6140; 1/4" (6.3 mm); (150 mm); CrV 50BV30; 1/4" (6.3 mm); (152.4 mm); CrV 50BV30

DRAWER / SZUFLADA 2

3x75 mm, 5x100 mm, 5x150 mm, 6x38 mm, 6x100 mm, 6x150 mm, 8x150 mm; CrV;
 PH0x100 mm, PH1x75 mm, PH1x100 mm, PH2x38 mm, H2x100 mm, PH2x150 mm, PH3x150 mm; CrV;
 180 mm; 160 mm; 160 mm;
 160 mm BENT / WYGIĘTE

DRAWER / SZUFLADA 3

6x7, 8x9, 10x11, 12x13, 14x15, 16x17, 18x19 mm; 22, 24, 27, 28, 30, 32 mm; 6, 7, 8, 9, 10, 11, 12, 13, 14, 15, 16, 17, 18, 19, 20, 21 mm

DRAWER / SZUFLADA 4

1/2" (12.7 mm): 8, 9, 10, 11, 12, 13, 14, 15, 16, 17, 18, 19, 20, 21 mm (L=76 mm); CrV 50BV30;
 1/2" (12.7 mm), 3/8" (9.5 mm): H4, H5, H6, H7, H8, H10, H12 (L=30 mm); H4, H5, H6, H7, H8, H10, H12 (L=75 mm); CrV; M5, M6, M7, M10, M12 (L=30 mm); M5, M6, M7, M10, M12 (L=75 mm); CrV; T20, T25, T30, T40, T45, T50, T55 (L=30 mm); T20, T25, T30, T40, T45, T50, T55 (L=75 mm); CrV;
 300 g (L=300 mm); 40 mm (L=300 mm); 10x8x142 mm, 12x10x152 mm, 16x13x170 mm



No.	drawers / szuflady	
58540	6	1

- PL Szafka serwisowa
- GB Roller cabinet
- D Werkstattrollwagen
- RUS Инструментальный кабинет
- CZ Dílenská skříňka
- RO Dulap de scule
- H Gőrgős szerszámtároló
- E Armario en ruedas

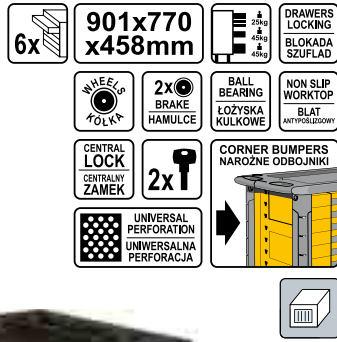

No.	drawers / szuflady	
58539	6	1

- PL Smarownica
- GB Lever grease gun
- D Handhebel fettpresse
- RUS Ручной смазочный шприц
- CZ Maznice na šmír
- RO Pistol de gresat-vaselina
- H Sirző /tömlővel/
- E Engrasador

400ml



No.	ml	
78040	400	10

- PL Smarownica
- GB Lever grease gun
- D Handhebel fettpresse
- RUS Ручной смазочный шприц
- CZ Maznice na šmír
- RO Pistol de gresat-vaselina
- H Sirző /tömlővel/
- E Engrasador

400 cm³ AI

P(MPa) 41-69



No.	cm ³	
78041	400	5/10

- PL Szafka serwisowa
- GB Roller cabinet
- D Werkstattrollwagen
- RUS Инструментальный кабинет
- CZ Dílenská skříňka
- RO Dulap de scule
- H Gőrgős szerszámtároló
- E Armario en ruedas

745x620x335mm



No.	drawers / szuflady	
81830	6	1

- PL Smarownica
- GB Lever grease gun
- D Handhebel fettpresse
- RUS Ручной смазочный шприц
- CZ Maznice na šmír
- RO Pistol de gresat-vaselina
- H Sirző /tömlővel/
- E Engrasador

400 cm³



No.	cm ³	
78046	400	10

- PL Smarownica
- GB Lever grease gun
- D Handhebel fettpresse
- RUS Ручной смазочный шприц
- CZ Maznice na šmír
- RO Pistol de gresat-vaselina
- H Sirző /tömlővel/
- E Engrasador

400 cm³ AI

P(MPa) 41-69

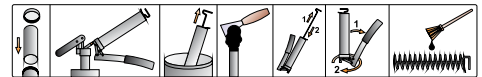

No.	cm ³	
78042	400	5/10

PL Towotnica
GB Lever grease gun
D Handhebel Fettpresse
RUS Ручной смазочный шприц

CZ Maznice na šmír
RO Pistol de gresat-vaselina
H Sírzó /tömlővel/
E Engrasador



No.	cm³	Box
78047	500	10

PL Smarownica
GB Lever grease gun
D Handhebel Fettpresse
RUS Ручной смазочный шприц

CZ Maznice na šmír
RO Pistol de gresat-vaselina
H Sírzó /tömlővel/
E Engrasador

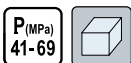
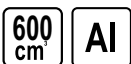

No.	cm³	Box
78043	600	6/12

PL Zestaw końcówek czteroszczękowych do smarownic
GB Heavy duty jaw couplers
D Mundstücksatz für Handhebel Fettpressen
RUS Соединительные патроны для масляного пистолета
CZ Sada koncovek k mazacímu lisu
RO Doza de legatura
H Tömlő csatlakozó karos zsírzóhoz
E Juego de boquillas para engrasadores



No.	Ø (mm)	pcs	Box
78061	15	4	20/80

PL Pompa ręczna do oleju
GB Manual oil pump
D Öl-Umfüllpumpe
RUS Ручной насос для перекачки масел

CZ Pumpa ruční na olej
RO Pompa manuala apa ulei
H Kézi olajszivattyú
E Bomba manual para aceite



No.	l / min	Box
78000	19	5

PL Towotnica
GB Lever grease gun
D Hand-fettpresse
RUS Ручной смазочный шприц

CZ Maznice na šmír
RO Pistol de gresat cu tija rigidă
H Sírzó /tömlővel/
E Engrasador



No.	cm³	Box
78050	445	15

PL Wężyk do towotnicy
GB Flexible tube for grease gun
D Schlauch für Fettpresse
RUS Шланг для шприца

CZ Hadička na maznice na šmír
RO Furtun flexibil pt. pistol de gresat
H Tömlő a zsírzóhoz
E Manguera para engrasador



No.	L (mm)	Box
78045	240	50/250

PL Wężyk giętki do smarownic
GB Flexible hose for grease gun
D Schlauch für Fettpresse
RUS Гибкий шланг для товотницы
CZ Hadička na maznice na šmír
RO Furtun flexibil pt. pistol de gresat
H Tömlő a zsírzóhoz
E Manguera para engrasador

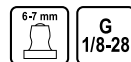

No.	L (mm)	Mpa	Box
78067	300	31	50/250
78068	500	31	50/250

PL Odsysarka ręczna do oleju
GB Oil drainer
D Öl-Absaugpumpe
RUS Ручной шприц для откачки масла

CZ Ruční odsávačka oleje
RO Pompa de ulei
H Kézi olajszivattyú
E Bomba de succión manual para aceite



No.	cm³	Box
78030	200	10

PL Odsysarka ręczna do oleju
 GB Oil drainer
 D Öl-Absaugpumpe
 RUS Ручной шприц для откачки масла

CZ Ruční odsávačka oleje
 RO Pompa de ulei
 H Kézi olajszivattyú
 E Bomba de succión manual para aceite



No.	cm ³	Icon
78031	400	10

PL Pompa ręczna do oleju
 GB Manual oil pump
 D Öl-Umfüllpumpe
 RUS Ручной насос для перекачки масел

CZ Pumpa ruční na olej
 RO Pompa manuala apa ulei
 H Kézi olajszivattyú
 E Bomba manual para aceite



No.	cm ³	Icon
78035	500	10

PL Oliwiarka z wężykiem
 GB Oil can with flexible hose
 D Ölkanne mit flexiblem Aufsatz
 RUS Масленка с гибким шлангом

CZ Olejova maznice
 RO Cana ulei cu furtun flexibil
 H Olajozó kanna, hajlékony tömlővel
 E Aceitera



No.	ml	Icon
78306	200	10/60

PL Klucz do filtra oleju
 GB Oil filter wrench
 D Ölfilterspinne
 RUS Съёмник масляных фильтров

CZ Klíč na filtr oleju
 RO Cheie pt. filtru de ulei
 H Olajszűrő kulcs
 E Llave de filtro



No.	size / rozmiar	Ø (mm)	Icon
57600	3/8" (10.0 mm)	65-110	6/36

PL Odsysarka ręczna do oleju
 GB Oil drainer
 D Öl-Absaugpumpe
 RUS Ручной шприц для откачки масла

CZ Ruční odsávačka oleje
 RO Pompa de ulei
 H Kézi olajszivattyú
 E Bomba de succión manual para aceite

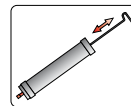

No.	cm ³	Icon
78044	500	10/20

PL Oliwiarka
 GB Oil can
 D Ölkanne
 RUS Масленка

CZ Maznička
 RO Pompiță de ulei
 H Olajozó
 E Aceitera



No.	ml	Icon
78300	300	15/60

PL Oliwiarka z końcówką sztywną
 GB Oil can with rigid spout
 D Ölkanne mit starrem Aufsatz
 RUS Масленка с твердым наконечником

CZ Olejová maznice
 RO Cana ulei cu furtun rigid
 H Olajozó kanna, merev szárral
 E Aceitera



No.	ml	Icon
78303	300	10/60

PL Klucz do filtra oleju, zaciskowy
 GB Oil filter wrench
 D Ölfilterschlüssel
 RUS Съёмник масляных фильтров замковый

CZ Klíč na filtr oleju svěrácí
 RO Cheie cu strângere pt. filtru de ulei
 H Olajszűrő kulcs, pattintos
 E Llave de filtro de apriete

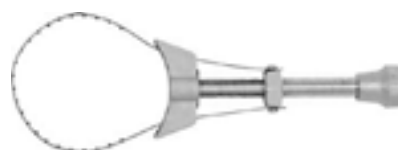

No.	Ø (mm)	Icon
57610	55-110	10/50

PL Klucz do filtra oleju
 GB Oil filter wrench
 D Ölfilterspinne
 RUS Съёмник масляных фильтров

CZ Klíč na filtr oleju
 RO Cheie pt. filtru de ulei
 H Olajszűrő kulcs
 E Llave de filtro



No.
57620

10/100

PL Klucz do filtra oleju
 GB Oil filter wrench
 D Ölfilterspinne
 RUS Съёмник масляных фильтров

CZ Klíč na filtr oleju
 RO Cheie pt. filtru de ulei
 H Olajszűrő kulcs
 E Llave para el filtro de aceite



No.
57640

25/100

PL Klucz do filtra oleju
 GB Oil filter wrench
 D Ölfilterschlüssel
 RUS Ключ к масляному фильтру

CZ Klíč na filtr oleju
 RO Cheie pt. filtru de ulei
 H Olajszűrő kulcs
 E Llave para el filtro de aceite



No.	Ø (mm)	
57612	73-85	12/48
57613	83-95	12/48
57614	93-111	12/48

PL Ściągacz do łożysk
 GB Gear puller
 D Dreiarmliger Abzieher
 RUS Съёмник подшипников 3-х лапчатый

CZ Stahovák na ložiska
 RO Clește cu 3 brațe pt. extras rulmenți
 H Hidraulikus csapágyelhúzó
 E Extractor de cojinetes



No.	mm	arms / ramiona	
80534	0-120	3	2/6

PL Klucz do filtra oleju
 GB Oil filter wrench
 D Ölfilterspinne
 RUS Съёмник масляных фильтров

CZ Klíč na filtr oleju
 RO Cheie pt. filtru de ulei
 H Olajszűrő kulcs
 E Llave de filtro



No.
57630

10/40

PL Klucz do filtra oleju
 GB Oil filter wrench
 D Ölfilterschlüssel
 RUS Ключ к масляному фильтру

CZ Klíč na filtr oleju
 RO Cheie pt. filtru de ulei
 H Olajszűrő kulcs
 E Llave para el filtro de aceite



No.	Ø (mm)	
57649	55-75	10/50
57650	75-95	10/50
57651	95-115	10/50

PL Ściągacz do łożysk
 GB Gear puller
 D Dreiarmliger Abzieher
 RUS Съёмник подшипников 3-х лапчатый
 CZ Stahovák na ložiska
 RO Clește cu 3 brațe pt. extras rulmenți
 H Hidraulikus csapágyelhúzó
 E Extractor de cojinetes



No.	mm	arms / ramiona	
80500	75	3	4/40
80510	100	3	5/30
80520	150	3	2/20
80530	200	3	2/12

PL Ściągacz do sprężyn
 GB Coil spring clamp
 D Federspanner
 RUS Стяжка пружин

CZ Stahovák na pružiny
 RO Dispozitiv pt. demontat arcuiri auto
 H Rugóelhúzó
 E Extractor de muelles



No.
80600

2

6/12

PL Ściągacz do sprężyn
GB Coil spring clamp
D Federspanner
RUS Стяжка пружин

CZ Stahovák na pružiny
RO Dispozitiv pt. demontat arcuiri auto
H Rugóelhúzó
E Extractor de muelles



No.	pcs packing	Box
80601	2	10

PL Ściągacz do sworzni kulistych
GB Tie rod end lifter
D Universal-Kugelgelenk-Abzieher
RUS Съёмник шаровых опор

CZ Stahovák kulových čepů řízení
RO Extractor pt. articulatii sferice
H Gömbfej kinyomó
E Extractor pt. articulatii sferice



No.	Box
80640	25

PL Krzyżakowy klucz do kół
GB Cross rim wrench
D Kreuzschlüssel
RUS Балонный ключ-крест

CZ Klíč na kola křížový
RO Cheie în cruce pt. roți
H Kereszt kerékkulcs
E Llave cruz para ruedas



No.	mm	Box
57010	17x19x21x23	20

PL Krzyżakowy klucz do kół
GB Cross rim wrench
D Kreuzschlüssel
RUS Балонный ключ-крест

CZ Klíč na kola křížový
RO Cheie în cruce pt. roți
H Kereszt kerékkulcs
E Llave cruz para ruedas



No.	mm	Box
57030	17x19x21x23	20

PL Ściągacz do sworzni kulistych
GB Tie rod end lifter
D Universal-Kugelgelenk-Abzieher
RUS Съёмник шаровых опор

CZ Stahovák kulových čepů řízení
RO Extractor pt. articulatii sferice
H Gömbfej kinyomó
E Extractor pt. articulatii sferice



No.	Box
80620	25/50

PL Krzyżakowy klucz do kół
GB Cross rim wrench
D Kreuzschlüssel
RUS Балонный ключ-крест

CZ Klíč na kola křížový
RO Cheie în cruce pt. roți
H Kereszt kerékkulcs
E Llave cruz para ruedas



No.	mm / inch (cale)	Box
57000	17x19x22x13/16" (20.6 mm)	20

PL Krzyżakowy klucz do kół
GB Cross rim wrench
D Kreuzschlüssel
RUS Балонный ключ-крест

CZ Klíč na kola křížový
RO Cheie în cruce pt. roți
H Kereszt kerékkulcs
E Llave cruz para ruedas



No.	mm / inch (cale)	Box
57020	17x19x21x1/2" (12.7 mm)	10

PL Krzyżakowy klucz do kół
GB Cross rim wrench
D Kreuzschlüssel
RUS Балонный ключ-крест

CZ Klíč na kola křížový
RO Cheie în cruce pt. roți
H Kereszt kerékkulcs
E Llave cruz para ruedas



No.	mm / inch (cale)	Box
57050	24x27x32x3/4" (19.0 mm)	5

PL Klucz do kół rozsuwany
GB L-type wheel wrench
D Radschlüssel
RUS Ключ баллонный телескопический L-типа

CZ Klíč na kola rozvírány
RO Cheie pt. roți extensibilă
H Kerékkulcs, kihúzható
E Llave para ruedas extensible

360-510
mm

17-19
mm

1/2"
12.5mm



VOREL

No.	mm	L (mm)	size / rozmiar	☐
57100	17/19	360-510	1/2" (12.5 mm)	10/20

PL Klucz do świec
GB Spark plug wrench
D Zündkerzenschlüssel
RUS Ключ свечной

CZ Svičkový klíč
RO Cheie pt. buji
H Gyertyakulcs
E Llave para bujias



VOREL

No.	mm	L (mm)	☐
57160	16	150	25/50
57210	21	150	25/50

PL Klucze do przewodów hamulcowych
GB Flare nut wrenches
D Bremsleitungschlüsselsatz
RUS Набор ключей разрезных

CZ Klíče na vedení brzd
RO Cheie pt. conducte de frână
H Fékcsőkulcs
E Llaves para tubería de frenado

3
PCS



VOREL

No.	pcs	☐
57700	3	12/60

PL Samochodowy próbnik napięcia
GB Car voltage tester
D Autospannungstester
RUS Пробник автомобильный

CZ Automobilový zkoušeč napětí
RO Creion de tensiune pt. automobile
H Autós fáziskereső
E Comprobador de corriente de coche



No.	v	☐
65270	6-24	20/200

PL Zaciskacz do pierścieni
GB Piston ring compressor
D Kolbenring-Spannband
RUS Зажим колец
CZ Svěrka na kroužky
RO Clește pt. strâns inele
H Gyűrűbepattintó
E Pinza para anillos

AISI
#304

65
Mn



VOREL

No.	Ø (mm)	H (mm)	☐
80660	50-125	75	36
80661	75-175	100	36

PL Klucz do świec
GB Spark plug wrench
D Zündkerzenschlüssel
RUS Ключ свечной

CZ Svičkový klíč
RO Cheie pt. buji
H Gyertyakulcs
E Llave para bujias



VOREL

No.	mm	L (mm)	☐
57260	16/21	150	25/50

PL Samochodowy próbnik napięcia
GB Car voltage tester
D Autospannungstester
RUS Пробник автомобильный

CZ Automobilový zkoušeč napětí
RO Creion de tensiune pt. automobile
H Autós fáziskereső
E Comprobador de corriente de coche



No.	v	☐
65260	6-24	20/200

PL Łapka do podnoszenia
GB Pick-up tool
D Starer Greifer
RUS Гибкий захват „Pick-up”

CZ Patka pro zdvihání
RO Surubelnita flexibilă
H Emelőlapka
E Grifo para recoger pick up

600
mm



No.	L (mm)	☐
78400	600	50/150

- PL Łapka magnetyczna, giętka
 GB Flexible pick-up handle, magnetic
 D Magnetisch flexibler Greifer
 RUS Гибкий магнитный захват
 CZ Vytahovák magnetický ohebný
 RO Surubelnita flexibilă magnetică
 H Mágneses felszedő eszköz, hajlékony nyél
 E Grifo magnético flexible



No.	L (mm)	
78401	530	50/100

- PL Taboret warsztatowy
 GB Workshop seat
 D Werkstatthocker
 RUS Табурет рабочий
- CZ Dilenský taburet
 RO Taburet atelier
 H Műhely zsámoly
 E Taburete de taller



No.	max (kg)	
81823	90	4

- PL Taboret warsztatowy teleskopowy
 GB Pneumatic car seat
 D Werkstatthocker, teleskopisch
 RUS Табурет рабочий подъемный
- CZ Dilenský taburet teleskopický
 RO Taburet atelier telescopic
 H Teleszkópos műhely zsámoly
 E Taburete de taller telescópico



No.	max (kg)	
81825	135	4

- PL Elektryczny klucz udarowy
 GB Electric impact wrench
 D Elektro-Schlagschrauber
 RUS Электрический гайковерт
 CZ Elektrický rázový utahovák
 RO Cheie electrică
 H Elektromos ütvecsavarozó
 E llave de impacto eléctrica

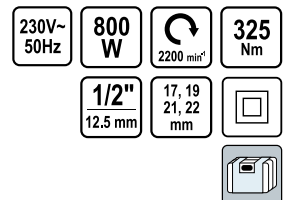

No.	W	min-1	
57091	800	2200	5

$L_{pA} = 87,5 \pm 3,0$ dB;
 $L_{pA} = 98,5 \pm 3,0$ dB;
 $a_w = 9,93 \pm 1,5$ m/s²

- PL Chwytnak teleskopowy LED
 GB LED magnetic pick up tool
 D LED Magnet Heber
 RUS Захват магнитный телескопический с подсветкой
 CZ Patka magnetická teleskopická LED
 RO Telescop magnetic cu LED
 H LED felszedő mágnes teleszkópos nyéllel
 E Herramienta para levantar, telescópica, con LED

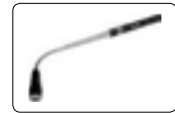

No.	LED	battery / bateria	
78405	3	4xLR44	12/48

- PL Taboret warsztatowy z szufladą
 GB Workshop seat with drawer
 D Werkstatthocker mit Schublade
 RUS Табурет рабочий с ящиком
- CZ Dilenský taburet se zásuvkou
 RO Taburet atelier cu sertar
 H Műhely zsámoly fiókkal
 E Taburete de taller con cajón

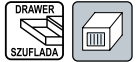

No.	max (kg)	
81824	90	4

- PL Leżanka warsztatowa na kółkach
 GB Workshop creeper
 D Werkstattliegewagen auf Rädern
 RUS Лежак ремонтный
- CZ Lehátko montážní na kolečkách
 RO Targa auto mobilă
 H Fekpad gurulós
 E Camilla de taller con ruedas



No.	mm	
81820	930x440x105	1

- PL Elektryczny klucz udarowy
- GB Electric impact wrench
- D Elektro-Schlagschrauber
- RUS Электрический гайковерт
- CZ Elektrický rázový uťahovák
- RO Cheie electrică
- H Elektromos ütvecsavarozó
- E llave de impacto eléctrica

230-240V~50Hz	1100 W	2200 min ⁻¹	450 Nm
1 1/2" 12.5 mm	17, 19, 21, 22 mm	4 m	



$L_{pik} = 89,0 \pm 3,0$ dB; $L_{uik} = 100,0 \pm 3,0$ dB; $a_v = 10,04 \pm 1,5$ m/s²

No.	W	min-1	
57092	1100	2200	2

- PL Diodowa lampa bezprzewodowa
- GB Rechargeable work lamp
- D Led Werkstattlampe
- RUS Светодиодная беспроводная лампа
- CZ Montážní lampa diodová bezpřívodová
- RO Lampa cu led fara cablu
- H Ledlampa
- E Lámpara inalámbrica de diodos

SMD LED

12 LED	200 lm	CHARGING TIME CZAS ŁADOWANIA 4 h	WORK TIME CZAS PRACY 4.5 h
12 V 2000mAh Li-Ion	230V~50Hz BATTERY CHARGER ŁADOWNIARKA	12 V BATTERY CHARGER ŁADOWNIARKA	HOOK HAK



14

VOREL

No.	LED	mAh	
82728	12	2000	20

- PL Diodowa lampa bezprzewodowa
- GB Rechargeable work lamp
- D Led Werkstattlampe
- RUS Светодиодная беспроводная лампа
- CZ Montážní lampa diodová bezpřívodová
- RO Lampa cu led fara cablu
- H Ledlampa
- E Lámpara inalámbrica de diodos

3W	200 lm	3.7V 2000mAh Li-Ion	12V BATTERY CHARGER ŁADOWNIARKA	FRONT LIGHTING FUNKCJA LATARKI
230V~50Hz BATTERY CHARGER ŁADOWNIARKA	MAGNETIC	WORK TIME CZAS PRACY 4 h	CHARGING TIME CZAS ŁADOWANIA 4 h	HOOK HAK



COB LED

VOREL

No.	W	mAh	
82719	3	2000	20

- PL Elektryczny klucz udarowy
- GB Electric impact wrench
- D Elektro-Schlagschrauber
- RUS Электрический гайковерт
- CZ Elektrický rázový uťahovák
- RO Cheie electrică
- H Elektromos ütvecsavarozó
- E llave de impacto eléctrica

230-240 V~50 Hz	1100 W	2200 min ⁻¹	800 Nm
3/4" 19 mm	24, 30, 32, 36 mm	4 m	



$L_{pik} = 89,0 \pm 3,0$ dB; $L_{uik} = 100,0 \pm 3,0$ dB; $a_v = 10,04 \pm 1,5$ m/s²

No.	W	min-1	
57097	1100	2200	2

- PL Diodowa lampa bezprzewodowa
- GB Rechargeable work lamp
- D Led Werkstattlampe
- RUS Светодиодная беспроводная лампа
- CZ Montážní lampa diodová bezpřívodová
- RO Lampa cu led fara cablu
- H Ledlampa
- E Lámpara inalámbrica de diodos

30 LED	120 lm	6000K	IP20	12V BATTERY CHARGER ŁADOWNIARKA	230V~50Hz BATTERY CHARGER ŁADOWNIARKA
3.7V 1200mAh Li-Ion	CHARGING TIME CZAS ŁADOWANIA 4.5 h	WORK TIME CZAS PRACY 3 h	HOOK HAK	MAGNETIC	



SMD LED

VOREL

No.	LED	mAh	
82729	30	1200	6/12

- PL Diodowa lampa bezprzewodowa
- GB Rechargeable work lamp
- D Led Werkstattlampe
- RUS Светодиодная беспроводная лампа
- CZ Montážní lampa diodová bezpřívodová
- RO Lampa cu led fara cablu
- H Ledlampa
- E Lámpara inalámbrica de diodos

36 LED	3.7V 1200mAh Li-Ion	230V~50Hz BATTERY CHARGER ŁADOWNIARKA	12 V BATTERY CHARGER ŁADOWNIARKA	CHARGING TIME CZAS ŁADOWANIA 4 h	WORK TIME CZAS PRACY 4 h
MAGNETIC	HOOK HAK				



VOREL

No.	LED	mAh	
82720	36	500	10/20

- PL Lampa robocza LED
- GB LED work light
- D LED Handleuchte
- RUS Светодиодный светильник для мастерской
- CZ Ruční svítidla LED
- RO Lampa portabila cu LED
- H LED lámpa
- E Lámpara de taller LED



3W	100 lm
2 LIGHTING MODES TRYBY ŚWIĘCENIA	WORK TIME CZAS PRACY 4 h
3.7V 800mAh Li-Ion	Micro USB
MAGNETIC	HOOK HAK



COB
LED



2 tryby świecenia: 100%, 50%
przytrzymanie przycisku: światło czerwone, pulsowanie, sos

No.	W	lumens	h	
82723	3	100	4	12/48

- PL Lampa robocza LED
- GB LED work light
- D LED Werkstattlampe
- RUS Светодиодный светильник для мастерской
- CZ Ruční svítidla LED
- RO Lampa portabila cu LED
- H LED lámpa
- E Lámpara de taller LED

230V~50Hz	400 lm	24 LED
HOOK HAK	4.5 W	5.0m



SMD
LED



No.	W	LED	
82706	4.5	24	10/20

- PL Lampa warsztatowa
- GB Work light
- D Werkstattlampe
- RUS Лампа-переноска
- CZ Pracovní lampa
- RO Lampă pt. atelier
- H Szerelőlámpa
- E Lámpara de taller

230V~50Hz		E 27
100 W	5.0m	



No.	W	type	
82713	100	„PRACTIC“	10

- PL Lampa robocza LED
- GB LED work light
- D LED Werkstattlampe
- RUS Светодиодный светильник для мастерской
- CZ Ruční svítidla LED
- RO Lampa portabila cu LED
- H LED lámpa
- E Lámpara de taller LED

230V~50Hz	280 lm	16 LED
HOOK HAK	3.2 W	5.0m



SMD
LED



No.	W	LED	
82699	3.2	16	10/20

- PL Lampa warsztatowa
- GB Work light
- D Werkstattlampe
- RUS Лампа-переноска
- CZ Pracovní lampa
- RO Lampă pt. atelier
- H Szerelőlámpa
- E Lámpara de taller

230V~50Hz	TC-S	G23
11W	5.0m	



No.	W	type	
82705	11	„EFFECT“	10

- PL Lampa warsztatowa
- GB Work light
- D Werkstattlampe
- RUS Лампа-переноска
- CZ Pracovní lampa
- RO Lampă pt. atelier
- H Szerelőlámpa
- E Lámpara de taller

230V~50Hz		E 27
60W	5.0m	



No.	W	type	
82715	60	„PLASTIC“	10

PL Lampa warsztatowa
GB Work light
D Werkstattlampe
RUS Лампа-переноска

CZ Pracovní lampa
RO Lampă pt. atelier
H Szerelőlámpa
E Lámpara de taller

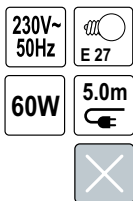

No.	W	type	☐
82712	60	„BASKET”	10

PL Lampa warsztatowa
GB Work light
D Werkstattlampe
RUS Лампа-переноска

CZ Pracovní lampa
RO Lampă pt. atelier
H Szerelőlámpa
E Lámpara de taller



No.	W	type	☐
82716	60	„GUMMI”	10
82717	100	„GUMMI”	10

PL Lampa robocza LED
GB LED work light
D LED Handleuchte
RUS Светодиодный светильник для мастерской
CZ Ruční svítidla LED
RO Lampa portabila cu LED
H LED lámpa
E Lámpara de taller LED



No.	LED	battery / bateria	☐
82730	20+3	3xAAA	12/48

PL Lampa robocza LED
GB LED work light
D LED Handleuchte
RUS Светодиодный светильник для мастерской
CZ Ruční svítidla LED
RO Lampa portabila cu LED
H LED lámpa
E Lámpara de taller LED



No.	battery / bateria	☐
82726	3xAAA	12/48

PL Lampa warsztatowa
GB Work light
D Werkstattlampe
RUS Лампа-переноска

CZ Pracovní lampa
RO Lampă pt. atelier
H Szerelőlámpa
E Lámpara de taller

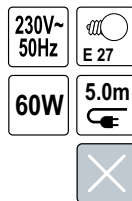

No.	W	type	☐
82714	60	„CLASSIC”	10

PL Lampa robocza LED
GB LED work light
D LED Handleuchte
RUS Светодиодный светильник для мастерской
CZ Ruční svítidla LED
RO Lampa portabila cu LED
H LED lámpa
E Lámpara de taller LED



No.	battery / bateria	☐
82724	3xAAA	12/48

PL Lampa robocza LED
GB LED work light
D LED Handleuchte
RUS Светодиодный светильник для мастерской
CZ Ruční svítidla LED
RO Lampa portabila cu LED
H LED lámpa
E Lámpara de taller LED



No.	LED	battery / bateria	☐
82731	24+3	3xAAA	12/48

PL Lampa robocza LED
GB LED work light
D LED Handleuchte
RUS Светодиодный светильник для мастерской
CZ Ruční svítidla LED
RO Lampa portabila cu LED
H LED lámpa
E Lámpara de taller LED

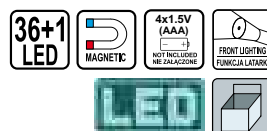

No.	LED	battery / bateria	☐
82735	36+1	4xAAA	12/48

- PL Lampa robocza LED
 GB LED work light
 D LED Handleuchte
 RUS Светодиодный светильник для мастерской
- CZ Ruční svítidla LED
 RO Lampa portabilă cu LED
 H LED lámpa
 E Lámpara de taller LED

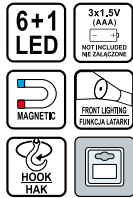

VOREL **SMB LED**

No.	LED	battery / bateria	
82742	6+1	3xAAA	12/48

- PL Latarka LED
 GB LED Flashlight
 D LED-Taschenlampe
 RUS Светодиодный фонарь
- CZ LED svítidla
 RO Lanterna cu LED
 H LED elem lámpa
 E Linterna LED

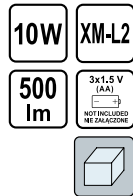

VOREL **POWER LED**

No.	battery / bateria	
88560	3xAAA	12/24

- PL Latarka LED
 GB LED Flashlight
 D LED-Taschenlampe
 RUS Светодиодный фонарь
- CZ LED svítidla
 RO Lanterna cu LED
 H LED elem lámpa
 E Linterna LED



VOREL **POWER LED**

No.	W	lumens	battery / bateria	
88550	3	150	3xAAA	12/48

- PL Zestaw latarka UV LED i okulary
 GB UV LED flashlight and glasses set
 D UV LED-Taschenlampe mit UV Schutzbrille
 RUS Комплект для проверки утечек хладагента - УФ фонарь 21-LED
- CZ UV LED svítidla + brýle
 RO Set lanterna UV LED si ochelari
 H UV LED zseblámpa + szemüveg
 E UV LED linterna con gafas para



VOREL **UV LED**

No.	LED	battery / bateria	
82756	21	3xAAA	80

- PL Latarka LED
 GB LED Flashlight
 D LED-Taschenlampe
 RUS Светодиодный фонарь
- CZ LED svítidla
 RO Lanterna cu LED
 H LED elem lámpa
 E Linterna LED

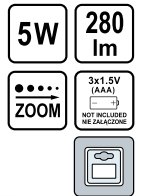

VOREL **POWER LED**

No.	battery / bateria	
88555	3xAAA	12/48

- PL Podnośnik hydrauliczny słupkowy
 GB Hydraulic bottle jack
 D Hydraulischen Wagenheber
 RUS Домкрат гидравлический „Бутылочный”
- CZ Pístový zvedák hydraulický
 RO Cric hidrolic cu piston
 H Hidraulikus emelő
 E Gato de embolo hidr.



VOREL

No.	max t	↑ mm	
80012	2	148-276	6
80022	3	180-350	6
80032	5	185-355	4
80042	8	190-365	4
80052	10	195-375	4
80062	12	200-380	3
80072	15	205-390	2
80082	20	217-402	2

PL Dźwignik tłokowy hydrauliczny
GB Hydraulic floor jack
D Hydraulischer Rangierwagenheber
RUS Домкрат гидравлический подкатной

CZ Pístový zvedák hydraulický – pracovní
RO Cric hidraulic cu piston pt. atelier
H Hidraulikus emelő – szervíz
E Gato de embolo hidr.rana

2t



VOREL

No.	max t	↑ mm	Icon
80111	2	135-325	1

PL Dźwignik tłokowy hydrauliczny
GB Hydraulic floor jack
D Hydraulischer Rangierwagenheber
RUS Домкрат гидравлический подкатной

CZ Pístový zvedák hydraulický – pracovní
RO Cric hidraulic cu piston pt. atelier
H Hidraulikus emelő – szervíz
E Gato de embolo hidr.rana

2t



VOREL

No.	max t	↑ mm	Icon
80120	2	130-360	1

PL Dźwignik tłokowy hydrauliczny
GB Hydraulic floor jack
D Hydraulischer Rangierwagenheber
RUS Домкрат гидравлический подкатной

CZ Pístový zvedák hydraulický – pracovní
RO Cric hidraulic cu piston pt. atelier
H Hidraulikus emelő – szervíz
E Gato de embolo hidr.rana

3t



VOREL

No.	max t	↑ mm	Icon
80233	3	150-485	1

PL Podnośnik mechaniczny trapezowy
GB Scissors jack
D Trapezwagenheber
RUS Домкрат механический ромбовый

CZ Lichoběžníkový zvedák
RO Cric mecanic
H Trapézemelő
E Gato mecanico-trapezoidal



No.	t	↑ mm	Icon
80271	1.2	100-350	4

PL Dźwignik tłokowy hydrauliczny
GB Hydraulic floor jack
D Hydraulischer Rangierwagenheber
RUS Домкрат гидравлический подкатной

CZ Pístový zvedák hydraulický – pracovní
RO Cric hidraulic cu piston pt. atelier
H Hidraulikus emelő – szervíz
E Gato de embolo hidr.rana

2t



VOREL

No.	max t	↑ mm	Icon
80121	2	130-350	1

PL Dźwignik tłokowy hydrauliczny
GB Hydraulic floor jack
D Hydraulischer Rangierwagenheber
RUS Домкрат гидравлический подкатной

CZ Pístový zvedák hydraulický – pracovní
RO Cric hidraulic cu piston pt. atelier
H Hidraulikus emelő – szervíz
E Gato de embolo hidr.rana

2.25t



VOREL

No.	max t	↑ mm	Icon
80220	2.25	140-520	1

PL Podnośnik mechaniczny trapezowy
GB Scissors jack
D Trapezwagenheber
RUS Домкрат механический ромбовый

CZ Lichoběžníkový zvedák
RO Cric mecanic
H Trapézemelő
E Gato mecanico-trapezoidal



VOREL

No.	t	↑ mm	Icon
80252	1.5	95-390	5

PL Podstawa pod samochód
GB Jack stand
D Unterstellbock
RUS Подставка для автомобиля
CZ Podstavec pod auto
RO Chituc de metal
H Gépkocsi alátét
E Apoyos de coche

2t



No.	t	↑ mm	Icon
80300	2	250-380	5

- PL Podstawka pod samochód
GB Jack stand
D Unterstellbock
RUS Подставка для автомобиля
CZ Podstavec pod auto
RO Chituc de metal
H Gépkocsi alátét
E Apoyos de coche



VOREL

No.	t	↑ mm	pcs / packing	
80307	2	265-415	2	1
80308	3	280-420	2	1.
80309	6	382-600	2	1.

- PL Rozpierzak hydrauliczny
GB Porta power repair kit
D Hydraulischer Richt und Ausbeulsatz
RUS Гидравлическая распорная стойка в наборе
- CZ Hydraulický rozpěrák
RO Trusa pompa hidraulica + accesorii
H Hidraulikus bontó
E Cilindro de freno



VOREL

No.	t	
80402	4	1

- PL Pompa do rozpieraka hydraulicznego
GB Accessories for porta power
D Druckeinheit für Hydr. Spreizer
RUS Ручной насос для гидравлической распорной стойки
- CZ Pumpa na hydraulický rozpěrák
RO Pompa hidraulica
H Szivattyú hidraulikus bontóhoz
E Bomba para cilindro de freno



VOREL

No.	t	
80320	4	2
80330	10	2

- PL Siłownik do rozpieraka hydraulicznego
GB Accessories for porta power
D Kraftzylinder für Hydr. Spreizer
RUS Сервомотор для гидравлической распорной стойки
- CZ Servomotor na hydraulický rozpěrák
RO Accesorii pompa hidraulica
H Erőátvitel a hidraulikus bontóhoz
E Servo para cilindro de freno



VOREL

No.	t	
80340	4	4
80350	10	4

- PL Podstawka pod samochód
GB Jack stands
D Unterstellbock
RUS Подставка для автомобиля
CZ Podstavec pod auto
RO Chituc de metal
H Gépkocsi alátét
E Apoyos de coche



VOREL

No.	t	↑ mm	pcs / packing	
80312	2	280-370	2	5

- PL Rozpierzak hydrauliczny
GB Porta power repair kit
D Hydraulischer Richt und Ausbeulsatz
RUS Гидравлическая распорная стойка в наборе
- CZ Hydraulický rozpěrák
RO Trusa pompa hidraulica + accesorii
H Hidraulikus bontó
E Cilindro de freno



VOREL

No.	t	
80412	10	1

- PL Ściągacz blacharski hydrauliczny
GB Pull - back ram
D Hydraulische Zugzylindereinheit
RUS Гидравлическая стяжка-крюк
- CZ Klempířské stahovadlo hydraulické
RO Carlig hidraulic tractorare
H Hidraulikus lemezkihúzó
E Extractor de latoneria de fontanero

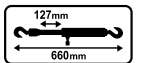

VOREL

No.	t	MPa	
80450	10	55	4

- PL Prostownik
GB Rectifier
D Batterieladegerät
RUS Зарядное устройство
- CZ Usměřňovač
RO Redresor
H Akkumulátortöltő
E Rectificador

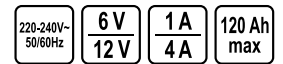

STHOR

No.	V	A	Ah max	
82555	6 / 12	1 / 4	120	18

- PL Prostownik
GB Rectifier
D Batterie-ladegerät
RUS Зарядное устройство
CZ Usměřovač
RO Redresor
H Akkumulátortöltő
E Rectificador



VOREL

No.	V	A	Ah	
82550	12	2.8	8-56	10
82551	12	4.2	12-84	10

- PL Ciśnieniomierz samochodowy
GB Tire pressure gauge
D Reifendruckprüfer
RUS Шинный манометр
- CZ Automobilový tlakoměr
RO Manometru
H Gépkocsi nyomásmérő
E Manómetro de coche

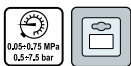

VOREL

No.	MPa	bar	
82610	0.05-0.75	0.5-7.5	25/150

- PL Ciśnieniomierz do aut ciężarowych
GB Dual foot tire gauge
D Reifendruckprüfer
RUS Шинный манометр для грузовых машин
- CZ Tlakoměr na nákladní auta
RO Indicator de presiune pt. camioane
H Nyomásmérő tehergépkocsikhoz
E Manómetro de caomones



VOREL

No.	MPa	bar	
82650	0.05-0.75	0.5-7.5	10/100

- PL Pompka nożna z manometrem
GB Foot pump with manometer
D Fussluftpumpe mit Manometer
RUS Насос ножной с манометром
- CZ Nožní pumpa z manometrem
RO Pompă de picior cu manometru
H Lábumpu nyomásmérővel
E Bomba de pierna con manometro



No.	
82000	20

- PL Prostownik
GB Rectifier
D Batterie-ladegerät
RUS Зарядное устройство
CZ Usměřovač
RO Redresor
H Akkumulátortöltő
E Rectificador



VOREL

No.	V	A	Ah	
82552	6 / 12	5.8	12-116	5
82553	6 / 12	10.3	26-206	5

- PL Ciśnieniomierz samochodowy
GB Tire pressure gauge
D Reifendruckprüfer
RUS Шинный манометр
- CZ Automobilový tlakoměr
RO Manometru
H Gépkocsi nyomásmérő
E Manómetro de coche

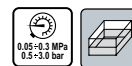

VOREL

No.	MPa	bar	
82611	0.05-0.3	0.5-3.0	10

- PL Wyciągarka łańcuchowa
GB Chain block
D Kettenzug Flaschenzug
RUS Таль цепная
CZ Zvedák řetězový
RO Scripete cu lant
H Láncos csigásor emelő
E Cabria de cadena



VOREL

No.	kg	chain / łańcuch (m)	
80751	1000	3	1
80752	2000	3	1
80753	3000	3	1

- PL Pompka tłokowa nożna
GB Foot pump
D Fussluftpumpe mit Manometer
RUS Насос ножной с манометром
- CZ Nožní pumpa z manometrem
RO Pompă de picior
H Lábumpu nyomásmérővel
E Bomba de pierna con manometro



No.	MPa	
82005	0.7	5

- PL Pompka tłokowa nożna
GB Foot pump
D Fussluftpumpe mit Manometer
RUS Насос ножной с манометром
- CZ Nožní pumpa z manometrem
RO Pompa de picior
H Lábpumpa nyomásmérővel
E Bomba de pierna con manometro



VOREL

No.	MPa	Box
82001	0-0.7	12

- PL Pompka słupkowa ręczna
GB Hand pump
D Hand-Luftpumpe
RUS Насос ручной
CZ Hustilka ruční
RO Pompa de mana cu manometru
H Kézi pumpa
E Bomba de barrote de mano



No.	MPa	Box
82020	0.3	20

- PL Pompka słupkowa z manometrem
GB Hand pump with manometer
D Hand-Luftpumpe mit Manometer
RUS Насос ручной с манометром
CZ Pumpa z manometrem
RO Pompa de mana cu manometru
H Kézi pumpa manométerrel
E Bomba de barrote con manometro



VOREL

No.	MPa	Box
82022	0.1-1	10

- PL Linka holownicza
GB Tow rope
D Abschleppseil
RUS Трос автомобильный буксировочный
- CZ Těžný provázek
RO Șufă pt. remorcare
H Vonatökötél
E Cable de remorque



VOREL

No.	kg	Box
82205	2500	10

- PL Pompka tłokowa nożna
GB Foot pump
D Fussluftpumpe mit Manometer
RUS Насос ножной с манометром
- CZ Nožní pumpa z manometrem
RO Pompa de picior
H Lábpumpa nyomásmérővel
E Bomba de pierna con manometro



VOREL

No.	MPa	Box
82015	0-0.7	6

- PL Pompka słupkowa z manometrem
GB Hand pump with manometer
D Hand-Luftpumpe mit Manometer
RUS Насос ручной с манометром
CZ Pumpa z manometrem
RO Pompa de mana cu manometru
H Kézi pumpa manométerrel
E Bomba de barrote con manometro



VOREL

No.	MPa	Box
82021	1	10

- PL Linka holownicza
GB Tow rope
D Abschleppseil
RUS Трос автомобильный буксировочный
- CZ Těžný provázek
RO Șufă pt. remorcare
H Vonatökötél
E Cable de remorque



VOREL

No.	kg	Box
82201	1450	20

- PL Linka holownicza
GB Tow rope
D Abschleppseil
RUS Трос автомобильный буксировочный
- CZ Těžný provázek
RO Șufă pt. remorcare
H Vonatökötél
E Cable de remorque



VOREL

No.	kg	Box
82209	2500	8

PL Linka holownicza
GB Tow rope
D Abschleppseil
RUS Трос автомобильный буксировочный

CZ Tážný provázek
RO Șufă pt. remorcare
H Vonatőkötél
E Cable de remolque



VOREL

No.	kg	
82200	3500	12

PL Linka holownicza z szeklą
GB Tow rope
D Abschleppseil
RUS Трос автомобильный буксировочный

CZ Tážný provázek
RO Șufă pt. remorcare
H Vonatőkötél
E Cable de remolque



VOREL

No.	kg	
82225	2500	20

PL Linka holownicza z szeklą
GB Tow rope
D Abschleppseil
RUS Трос автомобильный буксировочный

CZ Tážný provázek
RO Șufă pt. remorcare
H Vonatőkötél
E Cable de remolque



VOREL

No.	kg	
82234	3500	12

PL Linka holownicza z hakiem
GB Tow rope
D Abschleppseil
RUS Трос автомобильный буксировочный

CZ Tážný provázek
RO Șufă pt. remorcare
H Vonatőkötél
E Cable de remolque

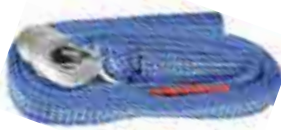

VOREL

No.	kg	
82233	2500	16

PL Linka holownicza
GB Tow rope
D Abschleppseil
RUS Трос автомобильный буксировочный

CZ Tážný provázek
RO Șufă pt. remorcare
H Vonatőkötél
E Cable de remolque



VOREL

No.	kg	
82206	3500	12

PL Linka holownicza z szeklą
GB Tow rope
D Abschleppseil
RUS Трос автомобильный буксировочный

CZ Tážný provázek
RO Șufă pt. remorcare
H Vonatőkötél
E Cable de remolque



VOREL

No.	kg	
82232	2500	16

PL Linka holownicza z hakiem
GB Tow rope
D Abschleppseil
RUS Трос автомобильный буксировочный

CZ Tážný provázek
RO Șufă pt. remorcare
H Vonatőkötél
E Cable de remolque



VOREL

No.	kg	
82231	1450	20

PL Szczotka do czyszczenia klemm
GB Battery clamps cleaner
D Klemmbürste
RUS Щетка для зачистки клемм

CZ Kartáč pro čištění svorek
RO Perie curatat borne auto
H Akkumulátorsaru tisztító kefe
E Cepillo para limpiar bornes



No.	
82440	10/160

PL Szczotka do czyszczenia klem
 GB Battery clamps cleaner
 D Klemmbürste
 RUS Щетка для зачистки клемм

CZ Kartač pro čištění svorek
 RO Perie curatat borne auto
 H Akkumulátorsaru tisztító kefe
 E Cepillo para limpiar bornes



VOREL

No.

82445



10/100

PL Próbnik akumulatorowy
 GB Battery hydrometer
 D Batteriesäureprüfer
 RUS Ареометр аккумуляторный

CZ Akumulátorový zkoušeč
 RO Instrument de verificare acumulator
 H Akkumulátorpróbaló
 E Probador de acumulador



No.

82520



10/100

PL Skrobaczka do szyb
 GB Car window scraper
 D Auto-Eiskratzer
 RUS Автомобильный скребок

CZ Škrabka na okna
 RO Razuiitor gheata
 H Jégkaparó
 E Rascadora para cristales



No.

82910



100

PL Guma do szyb z drewnianą rączką
 GB Window squeegee
 D Scheibenreiner-Holzstiel
 RUS Стеклоочиститель с резиной

CZ Guma do skel z dřevěnou rukojetí
 RO Lamă-ștergător cu miner pt. geamuri
 H Vízlehúzó gumi fa nyéllel
 E Goma para cristales con mango de madera



No.

82920



50

PL Komplet klem do akumulatora
 GB Battery clamps
 D Akku-Polklemmen
 RUS Клеммы аккумуляторные

CZ Sada svorek na akumulátor
 RO Set de cleme pt. acumulator
 H Akkumulátorsaru készlet
 E Juego de bornes para acumulador

2
PCS

BRASS
MOSIADZ



VOREL

No.

82431

pcs
packing

2



12

PL Wiązka przewodów awaryjnych
 GB Boosters cables
 D Starthilfekabel
 RUS Старт-кабель

CZ Spouštěcí kabele
 RO Cabluri de alimentare
 H Indítókábel
 E Pinzas de arranque



No.

82501

A

120



6

82502

200



14

82504

400



6

82506

600



4

PL Szczotka do samochodu
 GB Eureka duster
 D Waschbürste
 RUS Щетка-моп для мытья машин

CZ Kartač na auto
 RO Perie pt. mașină
 H Autómósó kefe
 E Cepillo de coche



No.

82939



25/50

PL Lejek
 GB Flexible funnel
 D Trichter
 RUS Воронка гибкая

CZ Nálevka
 RO Pálnie
 H Kétrészes tölcsér
 E Embudo



VOREL

No.

83000



30

14

PL Lejek
GB Flexible funnel
D Trichter
RUS Воронка гибкая

CZ Nálevka
RO Pâlnie
H Kétrészes tölcser
E Embudo



VOREL

No.	
83001	30

PL Lejek rolniczny
GB Agricultural funnel
D Landwirtschaftlich trichter
RUS Сельскохозяйственная воронка

CZ Trychtýř zemědělský
RO Pâlnie agricole
H Mezőgazdasági tölcser
E Embudo agrícola



VOREL

No.	diameter / średnica (mm)	
83004	210	25

PL Odkurzacz samochodowy
GB Car vacuum cleaner
D Handsauger
RUS Ручной пылесос для автомобиля

CZ Vysavač do auta
RO Aspirator de masina
H Autó porszívó
E Aspirador para coche



STHOR

No.	W	V	
82951	100	12	8

PL Apteczka samochodowa
GB First aid kit
D Verbandkasten
RUS Аптечка автомобильная

CZ Příruční lékárnička první pomoci
RO Trusă medicală de prim-ajutor
H Elsősegély doboz
E Botiquin



No.	type	
83260	E-01	10

PL Lejek
GB Flexible funnel
D Trichter
RUS Воронка гибкая

CZ Nálevka
RO Pâlnie
H Kétrészes tölcser
E Embudo



VOREL

No.	
83002	30

PL Lejek
GB Funnel
D Trichter
RUS Воронка

CZ Nálevka
RO Pâlnie
H Kétrészes tölcser
E Embudo



VOREL

No.	pcs	diameter / średnica (mm)	height / wysokość (mm)	
83005	4	52; 76; 100; 120	75; 110; 125; 152	30

PL Gaśnica samochodowa
GB Powder fire extinguisher
D Pulverlöscher
RUS Огнетушитель порошковый автомобильный
CZ Hasiči přístroj práškový
RO Extinctör cu pudră
H Porralöltő akasztóval
E Extintor de polvo bc con soporte



No.	kg	
83270	1	6

PL Apteczka samochodowa
GB First aid kit
D Verbandkasten
RUS Аптечка автомобильная

CZ Příruční lékárnička první pomoci
RO Trusă medicală de prim-ajutor
H Elsősegély doboz
E Botiquin



No.	type	
83261	E-04	5

PL Apteczka samochodowa
 GB First aid kit
 D Verbandkasten
 RUS Аптечка автомобильная

CZ Příruční lékárnička první pomoci
 RO Trusă medicală de prim-ajutor
 H Elsősegély doboz
 E Botiquin



No.	type	
83262	E-03	5

PL Apteczka metalowa
 GB Metal first aid kit
 D Apotheke aus Metall
 RUS Металлическая аптечка

CZ Kovová lékárnička
 RO Trusă medicală din metal
 H Fém elsősegély doboz
 E Botiquin de metal



No.	type	dimensions / wymiary (mm)
83267	E300	300x220x120

PL Spinacz bagażu
 GB Elastic tie down
 D Gepäckspinnensatz
 RUS Стяжка для багажа-8 крючков

CZ Elastické spínatka
 RO Cordelina elastica
 H Csomagrógzítő pök
 E Pulpo 8-ramion



No.	L (cm)	Ø (mm)	arms / ramiona
82300	80	8	8



No.	L (cm)	Ø (mm)	arms / ramiona
82301	80	8	8

PL Ściągacze elastyczne
 GB Elastic straps
 D Gummispannseil
 RUS Стяжка для багажа

CZ Elastické spínatka
 RO Cordelina elastica
 H Rugalmas feszítő
 E Pulpos



2 PCS 120 cm



No.	L (cm)	Ø (mm)	pcs packing
82305	120	12	2

PL Apteczka metalowa
 GB Metal first aid kit
 D Apotheke aus Metall
 RUS Металлическая аптечка

CZ Kovová lékárnička
 RO Trusă medicală din metal
 H Fém elsősegély doboz
 E Botiquin de metal



No.	type	dimensions / wymiary (mm)
83266	E240	240x220x120

PL Trójkąt ostrzegawczy
 GB Vehicle safety triangle
 D Warndreieck
 RUS Предупреждающий треугольник

CZ Výstražný trojuholník
 RO Triunghi de avertizare
 H Elakadásjelző háromszög
 E Triángulo de emergencia



No.	
83280	40

PL Ściągacze elastyczne
 GB Elastic straps
 D Gummispannseil
 RUS Стяжка для багажа

CZ Elastické spínatka
 RO Cordelina elastica
 H Rugalmas feszítő
 E Pulpos



2 PCS



No.	L (cm)	Ø (mm)	pcs packing
82308	80	8	2
82310	100	8	2
82315	150	8	2
82320	200	8	2

PL Płaskie ściągacze elastyczne
 GB Elastic straps
 D Gummispannseil
 RUS Стяжка для багажа

CZ Elastické spínatka
 RO Cordelina elastica
 H Rugalmas feszítő
 E Pulpos



2 PCS



No.	L (cm)	pcs packing
82360	80	2
82370	100	2

- PL Taśma do bagażu ze sprzączką
- GB Ratchet tie down
- D Spanngurt
- RUS Ремни для крепления груза с зажимом фиксатором
- CZ Pásky na zavazadla
- RO Cordelina pt. bagaje cu clichet
- H Csomagrögzítő pánt
- E Cintas para equipaje



No.	L (cm)	W (mm)	pcs packing	Box
82331	250	25	2	10/80

- PL Taśma do bagażu
- GB Ratchet tie down
- D Spanngurt
- RUS Ремень для крепления багажа с трещоткой
- CZ Pás na zavazadla z napínáním
- RO Cordelina pt. bagaje cu clichet
- H Csomagrögzítő pánt feszítővel
- E Cinta para equipaje con carraca



No.	L (m)	daN	W (mm)	Box
82377	2	1000	35	10
82378	4	1000	35	10
82379	6	1000	35	10
82380	8	1000	35	10

- PL Taśma do bagażu
- GB Ratchet tie down
- D Spanngurt
- RUS Ремень для крепления багажа с трещоткой
- CZ Pás na zavazadla z napínáním
- RO Cordelina pt. bagaje cu clichet
- H Csomagrögzítő pánt feszítővel
- E Cinta para equipaje con carraca



No.	L (m)	daN	W (mm)	Box
82372	4	1600	50	8
82373	6	1600	50	7
82374	8	1600	50	6
82375	10	1600	50	5
82384	6	2000	50	6
82386	8	2000	50	6
82388	10	2000	50	5
82390	12	2000	50	5

- PL Taśma do bagażu ze sprzączką
- GB Ratchet tie down
- D Spanngurt
- RUS Ремни для крепления груза с зажимом фиксатором
- CZ Pásky na zavazadla
- RO Cordelina pt. bagaje cu clichet
- H Csomagrögzítő pánt
- E Cintas para equipaje



No.	L (m)	W (mm)	Box
82341	5	25	12/48

- PL Taśma do bagażu
- GB Ratchet tie down
- D Spanngurt
- RUS Ремень для крепления багажа с трещоткой
- CZ Pás na zavazadla z napínáním
- RO Cordelina pt. bagaje cu clichet
- H Csomagrögzítő pánt feszítővel
- E Cinta para equipaje con carraca



No.	L (m)	W (mm)	Box
82351	5	25	12/48

- PL Taśma do bagażu
- GB Ratchet tie down
- D Spanngurt
- RUS Ремень для крепления багажа с трещоткой
- CZ Pás na zavazadla z napínáním
- RO Cordelina pt. bagaje cu clichet
- H Csomagrögzítő pánt feszítővel
- E Cinta para equipaje con carraca



No.	L (m)	W (mm)	pcs packing	Box
82400	5	25	2	8/16

- PL Taśma do bagażu
- GB Ratchet tie down
- D Spanngurt
- RUS Ремень для крепления багажа с трещоткой
- CZ Pás na zavazadla z napínáním
- RO Cordelina pt. bagaje cu clichet
- H Csomagrögzítő pánt feszítővel
- E Cinta para equipaje con carraca



No.	L (m)	daN	W (mm)	Box
82392	6	2500	50	6
82393	8	2500	50	6
82395	12	2500	50	5

PL Taśma do bagażu
GB Ratchet tie down
D Spangurt
RUS Ремень для крепления багажа с трещоткой

CZ Pás na zavazadla z napínáním
RO Cordelina pt. bagaje cu clichet
H Csomagrögzítő pánt feszítővel
E Cinta para equipaje con carraca



No.	L (m)	daN	W (mm)	
82343	4	1000	25	20

PL Plandeka
GB Tarpaulin
D Plane
RUS Тент

CZ Plachta
RO Husă
H Ponyva
E Toldo

57 g/m²



No.	m	g/m ²	
85122	2x3	57	30
85123	3x5	57	20
85124	4x5	57	10
85125	4x6	57	8
85126	5x8	57	5
85128	6x10	57	3
85129	8x12	57	2
85130	10x15	57	2

PL Plandeka
GB Tarpaulin
D Plane
RUS Тент

CZ Plachta
RO Husă
H Ponyva
E Toldo

VOREL

No.	m	g/m ²	
85020	2x3	90	30
85030	3x5	90	18
85040	4x5	90	9
85050	4x6	90	10
85060	5x8	90	5
85080	6x10	90	4
85090	8x12	90	2
85100	10x15	90	1



PL Taśma do bagażu
GB Ratchet tie down
D Spangurt
RUS Ремень для крепления багажа с трещоткой

CZ Pás na zavazadla z napínáním
RO Cordelina pt. bagaje cu clichet
H Csomagrögzítő pánt feszítővel
E Cinta para equipaje con carraca

2 PCS



No.	L (m)	daN	W (mm)	
82397	5	500	25	20

PL Plandeka
GB Tarpaulin
D Plane
RUS Тент

CZ Plachta
RO Husă
H Ponyva
E Toldo

75 g/m²



No.	m	g/m ²	
85112	2x3	75	30
85113	3x5	75	10
85114	4x5	75	10
85115	4x6	75	8
85116	5x8	75	5
85118	6x10	75	3
85119	8x12	75	2
85120	10x15	75	2

90 g/m²



14

Memo

15

Power tools & accessories
Elektronarzędzia i akcesoria



Power tools POWER UP
Elektronarzędzia POWER UP



214-217

Impact drills	
Wiertarki udarowe.....	214
Rotary hammers	
Młoty udarowe.....	214
Cordless tools	
Urządzenia akumulatorowe.....	214
Angle grinders	
Szlifierki kątowe.....	215
Multi-purpose oscillating tools	
Wielofunkcyjne narzędzia oscylacyjne.....	216
Circular saws	
Pilarki tarczowe.....	216
Pipe welders	
Zgrzewarki do rur.....	216

Power tools STHOR
Elektronarzędzia STHOR



218-229

Impact drills	
Wiertarki udarowe.....	218
Rotary hammers	
Młoty udarowe.....	218
Cordless tools	
Urządzenia akumulatorowe.....	219
Electric drill / drivers	
Wiertarko-wkrętarki sieciowe.....	224
Impact wrenches	
Klucze udarowe.....	224
Angle grinders	
Szlifierki kątowe.....	224
Multi-purpose oscillating tools	
Wielofunkcyjne narzędzia oscylacyjne.....	225
Orbital sanders	
Szlifierki mimośrodowe.....	225
Finishing sanders	
Szlifierki oscylacyjne.....	225
Belt sanders	
Szlifierki taśmowe.....	226
Jig saws	
Wyrzynarki.....	226
Hot air guns	
Opalarki.....	227
Glue guns	
Pistolety do klejenia.....	227
Spray guns	
Pistolety natryskowe.....	227
Industrial vacuum cleaners	
Odkurzacze przemysłowe.....	228
Soldering guns	
Lutownice.....	228
Paint & mortar mixers	
Mieszarki do zapraw i farb.....	228
Bench tools	
Elektronarzędzia stołowe.....	229
Pipe welders	
Zgrzewarki do rur.....	229
Water pumps	
Pompy wodne.....	229

Power tools LUND
Elektronarzędzia LUND

.....230-233



Impact drills	
Wiertarki udarowe.....	230
Rotary hammers	
Młoty udarowe.....	230
Angle grinders	
Szlifierki kątowe.....	230
Finishing sanders	
Szlifierki oscylacyjne.....	230
Car polishers	
Polerki samochodowe.....	230
Jig saws	
Wyrzynarki.....	231
Circular saws	
Pilarki tarczowe.....	231
Hot air guns	
Opalarki.....	231
Glue guns	
Pistolety do klejenia.....	232
Soldering guns	
Lutownice.....	232
Pipe welders	
Zgrzewarki do rur.....	233

Power tools FLO
Elektronarzędzia FLO

.....234-237



Cordless tools	
Urządzenia akumulatorowe.....	234
Water pumps	
Pompy wodne.....	235
Grass trimmers	
Podkaszarki.....	236
Hedge shears	
Nożyce do żywopłotu.....	237

Power tools
Elektronarzędzia

238

Industrial vacuum cleaners

Odkurzacze przemysłowe..... 238

Soldering guns

Lutownice..... 238

Accessories
Akcesoria

238-245

Grass trimmer lines

Żyłki tnące do podkaszarek..... 238

Discs

Tarcze..... 241

Drill chucks

Uchwyty wiertarskie..... 241

Adapters

Adaptery..... 241

Drill bit sharpeners

Ostrzałki do wiertel..... 241

Stands for power tools

Statywy do elektronarzędzi..... 242

Spare blades, brushes, etc. for power tools

Zapassowe ostrza, szczotki, końcówki do elektronarzędzi..... 242

Soldering iron accessories

Akcesoria do lutownic..... 243

Gasoline water pump accessories

Akcesoria do pomp spalinowych..... 245

PL Wiertarka udarowa
GB Impact drill
D Schlagbohrmaschine
RUS Дрель ударная
CZ Nárazová vrtáčka
RO Masina de gaurit
H Kezelési utasítás
E Taladradora de percusión

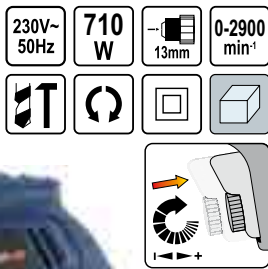

POWERUP

$L_{pA} = 92,0 \pm 3,0$ dB; $L_{wA} = 103,0 \pm 3,0$ dB; $a_n = 3,76 \pm 1,5 / 15,44 \pm 1,5$ m/s²

No.	W	min-1	☐
79013	710	0-2900	6

PL Zakrećarka udarowa
GB Impact wrench
D Schlagschrauber
RUS Ударный гайковёрт
CZ Rázový šroubovák
RO Maşină de infilţat cu percuşie
H Útvecsavarozó
E Atomilladora de impacto



POWERUP

$L_{pA} = 91,37 \pm 3,0$ dB; $L_{wA} = 102,37 \pm 3,0$ dB; $a_n = 1,99 \pm 1,5$ m/s²

No.	V	min-1	☐
78960	12	0-2300	10

PL Wiertarko-wkręćarka akumulatorowa
GB Cordless drill
D Akkuschauber
RUS Аккумуляторная дрель-шуруповёрт
CZ Vrtáčko-utahováč akumulátorový
RO Bormaşină-şurubelniţă cu acumulator
H Akkumulátoros fűrógép-csavarbehajtó
E Taladradora - atomilladora acu.

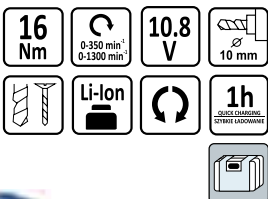

POWERUP

$L_{pA} = 66,9 \pm 3,0$ dB; $L_{wA} = 77,9 \pm 3,0$ dB; $a_n = 0,473 \pm 1,5$ m/s²

No.	V	min-1	Ø (mm)	☐
78970	10.8	0-350 / 0-1300	10	5

PL Motowiertarka
GB Rotary hammer
D Bohrhammer
RUS Перфоратор
CZ Vrtací kladivo
RO Ciocan rotatorpercutor
H Fűrókalapács
E Martillo perforador



POWERUP

$L_{pA} = 94,0 \pm 3,0$ dB; $L_{wA} = 105,0 \pm 3,0$ dB; $a_n = 19,190 \pm 1,5 / 14,760 \pm 1,5$ m/s²

No.	W	min-1	☐
79048	1800	0-800	2

PL Wiertarko-wkręćarka akumulatorowa
GB Cordless drill
D Akkuschauber
RUS Аккумуляторная дрель-шуруповёрт
CZ Vrtáčko-utahováč akumulátorový
RO Bormaşină-şurubelniţă cu acumulator
H Akkumulátoros fűrógép-csavarbehajtó
E Taladradora - atomilladora acu.

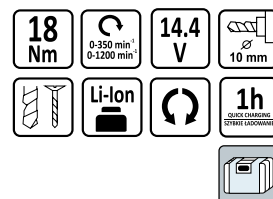

POWERUP

$L_{pA} = 63,60 \pm 3,0$ dB; $L_{wA} = 74,60 \pm 3,0$ dB; $a_n = 1,068 \pm 1,5 / 1,956 \pm 1,5$ m/s²

No.	V	min-1	Ø (mm)	☐
78971	14.4	0-350 / 0-1200	10	5

- PL Akumulator
- GB Battery
- D Akkumulator
- RUS Аккумулятор
- CZ Akumulátor
- RO Acumulatorul
- H Akkumulátor
- E Acumulador



No.	V	for / dla	box
78975	10.8	78970	40
78976	14.4	78971	30

- PL Szlifierka kątowa
- GB Angle grinder
- D Winkelschleifmaschine
- RUS Углошлифовальная машинка
- CZ Úhlová bruska
- RO Polizor unghiular
- H Sarokcsiszoló
- E Lijadera de angulo

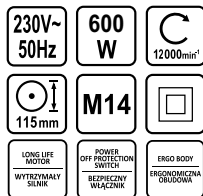

$L_{pA} = 88,2 \pm 3,0$ dB; $L_{wA} = 99,2 \pm 3,0$ dB; $a_n = 5,27 \pm 1,5$ m/s²

No.	W	min-1	box
79099	600	12000	6

- PL Szlifierka kątowa
- GB Angle grinder
- D Winkelschleifmaschine
- RUS Углошлифовальная машинка
- CZ Úhlová bruska
- RO Polizor unghiular
- H Sarokcsiszoló
- E Lijadera de angulo

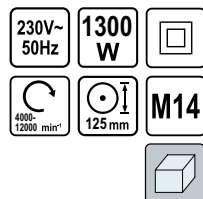

$L_{pA} = 95,3 \pm 3,0$ dB; $L_{wA} = 106,3 \pm 3,0$ dB; $a_n = 11,85 \pm 1,5 / 7,99 \pm 1,5$ m/s²

No.	W	min-1	box
79123	1300	4000-12000	6

- PL Ładowarka
- GB Battery charger
- D Ladegerät
- RUS Зарядное устройство
- CZ Nabíječka baterií
- RO Redresor
- H Akkumulátortöltő
- E Rectificador

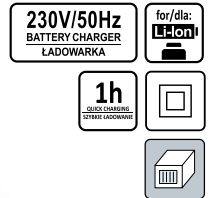

No.	for / dla	for / dla	box
78978	10.8	78970; 78975	20

- PL Szlifierka kątowa
- GB Angle grinder
- D Winkelschleifmaschine
- RUS Углошлифовальная машинка
- CZ Úhlová bruska
- RO Polizor unghiular
- H Sarokcsiszoló
- E Lijadera de angulo

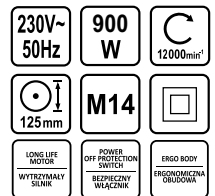

$L_{pA} = 90,7 \pm 3,0$ dB; $L_{wA} = 101,7 \pm 3,0$ dB; $a_n = 6,39 \pm 1,5$ m/s²

No.	W	min-1	box
79118	900	12000	6

- PL Pílarka dwutarczowa
- GB Double blade saw
- D Säge mit zwei Sägeblättern
- RUS Многоцелевая двухдисковая пила
- CZ Dvoukotoučová protiběžná píla
- RO Ferăstrău cu două discuri
- H Kéttárcsás daraboló
- E Máquina de serrar de dos discos

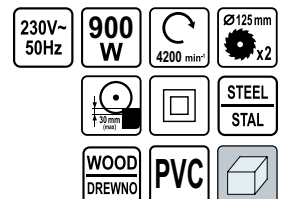

$L_{pA} = 90,0 \pm 3,0$ dB; $L_{wA} = 101,0 \pm 3,0$ dB; $a_n = 3,616 \pm 1,5 / 4,437 \pm 1,5$ m/s²

No.	W	min-1	box
79255	900	4200	4

PL Wielofunkcyjne narzędzie oscylacyjne
 GB Multi-purpose oscillating tool
 D Multifunktionales Oszillationswerkzeug
 RUS Многофункциональный инструмент
 CZ Multifunkční oscilační nářadí
 RO Unealtă multifuncțională oscilantă
 H Multifunkciós rezgő szerszám
 E Herramienta oscilatoria multiusos

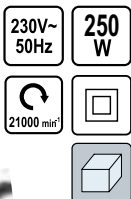

POWERUP

$L_{pA} = 86,0 \pm 3,0$ dB; $L_{wA} = 97,0 \pm 3,0$ dB; $a_n = 6,48 \pm 1,5$ m/s²

No.	W	min-1	☐
79237	250	21000	12

PL Pilarka ręczna
 GB Circular saw
 D Handkreissäge
 RUS Пила циркулярная ручная
 CZ Pila kotoučová
 RO Fierastru circular
 H Kézi körfűrészgép
 E Sierra de disco

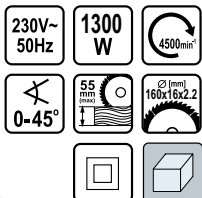

POWERUP

$L_{pA} = 95,5 \pm 3,0$ dB; $L_{wA} = 106,5 \pm 3,0$ dB; $a_n = 1,749 \pm 1,5 / 2,462 \pm 1,5$ m/s²

No.	W	min-1	☐
79252	1300	4500	4

PL Pilarka ręczna
 GB Circular saw
 D Handkreissäge
 RUS Дисковая пила
 CZ Pila kotoučová
 RO Fierastru circular
 H Kézi körfűrészgép
 E Sierra de disco

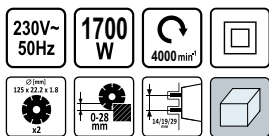

POWERUP

$L_{pA} = 101,88 \pm 3,0$ dB; $L_{wA} = 112,88 \pm 3,0$ dB; $a_n = 9,430 \pm 1,5 / 9,564 \pm 1,5$ m/s²

No.	W	min-1	☐
79275	1700	4000	2

PL Wielofunkcyjne narzędzie oscylacyjne
 GB Multi-purpose oscillating tool
 D Multifunktionales Oszillationswerkzeug
 RUS Многофункциональный инструмент
 CZ Multifunkční oscilační nářadí
 RO Unealtă multifuncțională oscilantă
 H Multifunkciós rezgő szerszám
 E Herramienta oscilatoria multiusos

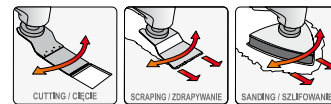
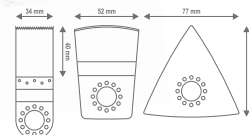

POWERUP

$L_{pA} = 84 \pm 3$ dB; $L_{wA} = 95 \pm 3$ dB; $a_n = 3,86 \pm 1,5$ m/s²

No.	W	min-1	☐
79239	400	15000-22000	6

PL Pilarka ręczna
 GB Circular saw
 D Handkreissäge
 RUS Пила циркулярная ручная
 CZ Pila kotoučová
 RO Fierastru circular
 H Kézi körfűrészgép
 E Sierra de disco

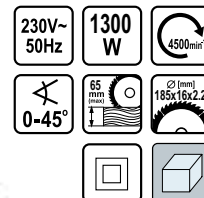

POWERUP

$L_{pA} = 95,5 \pm 3,0$ dB; $L_{wA} = 106,5 \pm 3,0$ dB; $a_n = 1,749 \pm 1,5 / 2,462 \pm 1,6$ m/s²

No.	W	min-1	☐
79253	1300	4500	4

PL Zgrzewarka do rur termoplastycznych
 GB PVC plastic pipe welder
 D Schweissgerät für thermoplastische Rohre
 RUS Сварочная машина для термопластиковых труб
 CZ Svářečka na termoplastické trubky
 RO Hegeștő berendezés termoplasztikus csővekhez
 H Masina de sudat tevi termoplastice
 E Maquina de soldar las tubos termoplasticos



POWERUP

No.	W	☐
78910	800-1500	5

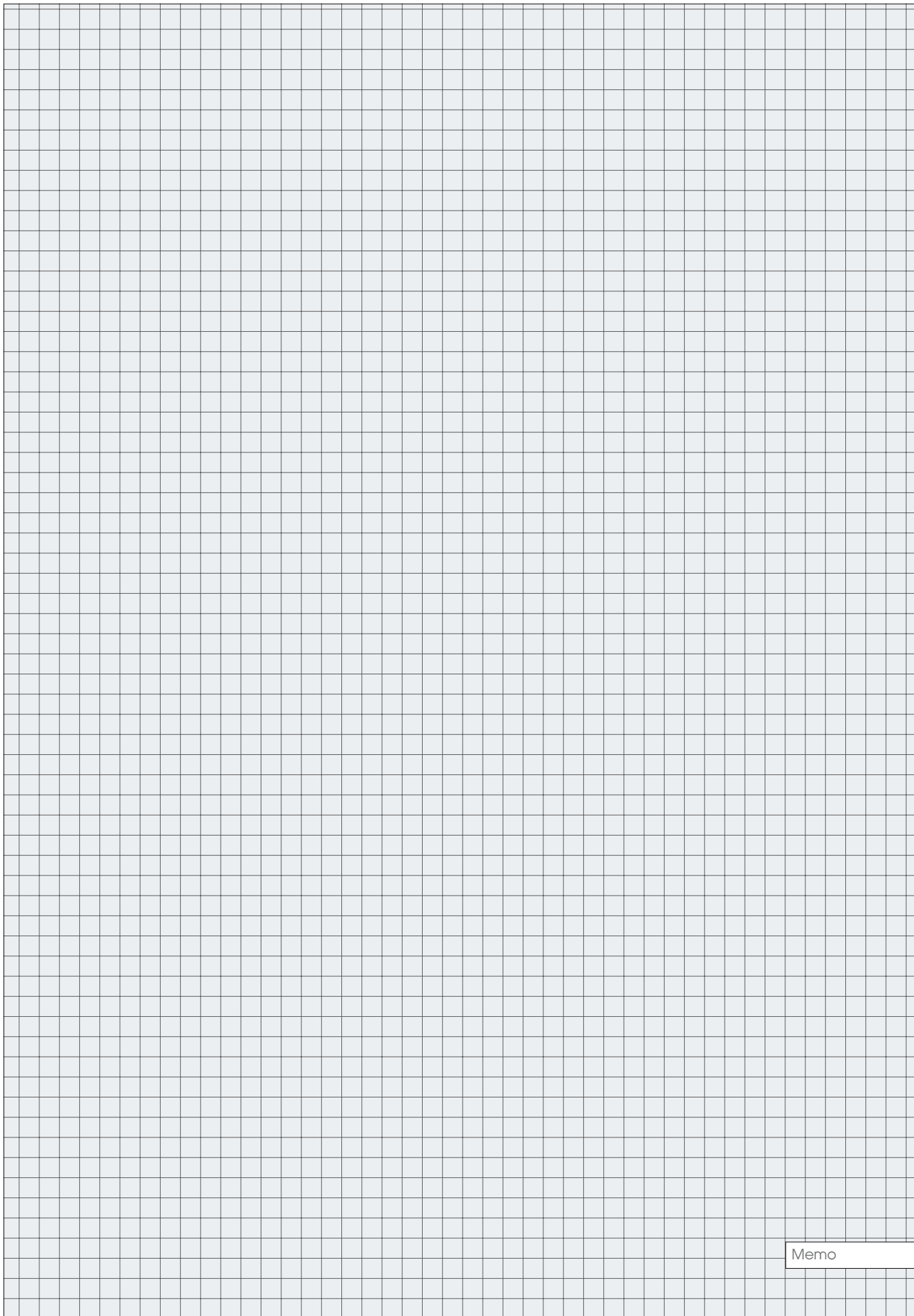

Memo

PL Wiertarka udarowa
GB Impact drill
D Schlagbohrmaschine
RUS Дрель ударная
CZ Nárazová vrtačka
RO Masina de gaurit
H Kezelési utasítás
E Taladradora de percusión

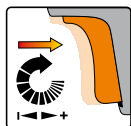
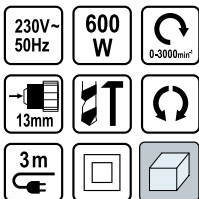

STHOR

$L_{pA} = 90,0 \pm 3,0$ dB; $L_{wA} = 101,0 \pm 3,0$ dB; $a_n = 2,39 \pm 1,5 / 7,67 \pm 1,5$ m/s²

No.	W	min-1	
78992	600	0-3000	8

PL Wiertarka udarowa
GB Impact drill
D Schlagbohrmaschine
RUS Дрель ударная
CZ Nárazová vrtačka
RO Masina de gaurit
H Kezelési utasítás
E Taladradora de percusión

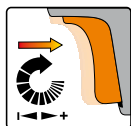
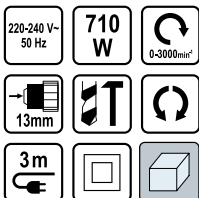

STHOR

$L_{pA} = 98,06 \pm 3,0$ dB; $L_{wA} = 109,06 \pm 3,0$ dB; $a_n = 5,726 \pm 1,5 / 17,116 \pm 1,5$ m/s²

No.	W	min-1	
78995	710	0-3000	8

PL Wiertarka udarowa
GB Impact drill
D Schlagbohrmaschine
RUS Дрель ударная
CZ Nárazová vrtačka
RO Masina de gaurit
H Kezelési utasítás
E Taladradora de percusión

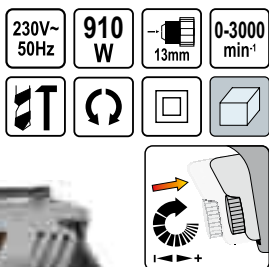

STHOR

$L_{pA} = 78,0 \pm 3,0$ dB; $L_{wA} = 89,0 \pm 3,0$ dB; $a_n = 2,93 \pm 1,5 / 8,43 \pm 1,5$ m/s²

No.	W	min-1	
79023	910	0-3000	10

PL Wiertarka udarowa
GB Impact drill
D Schlagbohrmaschine
RUS Дрель ударная
CZ Nárazová vrtačka
RO Masina de gaurit
H Kezelési utasítás
E Taladradora de percusión

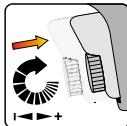
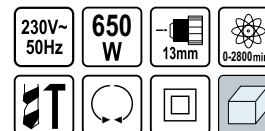

STHOR

$L_{pA} = 79,0 \pm 3,0$ dB; $L_{wA} = 90,0 \pm 3,0$ dB; $a_n = 2,67 \pm 1,5 / 8,00 \pm 1,5$ m/s²

No.	W	min-1	
79007	650	0-2800	10

PL Wiertarka udarowa
GB Impact drill
D Schlagbohrmaschine
RUS Дрель ударная
CZ Nárazová vrtačka
RO Masina de gaurit
H Kezelési utasítás
E Taladradora de percusión

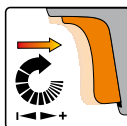
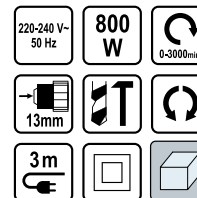

STHOR

$L_{pA} = 98,06 \pm 3,0$ dB; $L_{wA} = 109,06 \pm 3,0$ dB; $a_n = 5,726 \pm 1,5 / 17,116 \pm 1,5$ m/s²

No.	W	min-1	
78997	800	0-3000	8

PL Młotowiertarka
GB Rotary hammer
D Bohrhämmer
RUS Перфоратор
CZ Vrtací kladivo
RO Ciocan rotopercutor
H Fúrókalapács
E Martillo perforador

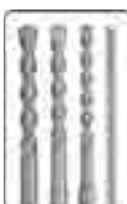

STHOR

$L_{pA} = 87 \pm 3$ dB; $L_{wA} = 98 \pm 3$ dB; $a_n = 12,353 \pm 1,5 / 9,433 \pm 1,5$ m/s²

No.	W	min-1	
79049	500	0-850	5

- PL Młotowiertarka SDS plus
- GB Rotary hammer
- D Bohrhammer
- RUS Перфоратор
- CZ Vrtací kladivo
- RO Ciocan rotopercutor
- H Fúrókalapács
- E Martillo perforador

230V~50Hz 620 W 0-870 min⁻¹ SDS PLUS 24.000 RPM 30 mm 13 mm 24 mm



STHOR

$L_{pa} = 92 \pm 3$ dB; $L_{wa} = 103 \pm 3$ dB; $a_n = 14,377 \pm 1,5 / 11,618 \pm 1,5$ m/s²

No.	W	min-1	Ø (mm)
79054	620	0-870	5

- PL Młot udarowy
- GB Rotary hammer
- D Bohrhammer
- RUS Перфоратор
- CZ Přeřezací kladivo
- RO Ciocan percutatnt
- H Fúrókalapács-gép
- E Martillo de percusión

230V~50Hz 1100 W 800 min⁻¹ SDS PLUS 40mm 13mm 26mm 3300 min⁻¹



STHOR

$L_{pa} = 92,6 \pm 3,0$ dB; $L_{wa} = 103,6 \pm 3,0$ dB; $a_n = 19,257 (14,718) \pm 1,5 / 15,241 (11,326) \pm 1,5$ m/s²

No.	W	min-1	Ø (mm)
79036	1100	800	3

- PL Wiertarko-wkrętarka akumulatorowa
- GB Cordless drill / driver
- D Akkuschrauber-und-Bohrer
- RUS Аккумуляторная дрель с шурупвертом
- CZ Akumulatorový vrtací sroubovák
- RO Bormasina-surubelnita cu acumulator
- H Akkumulátoros furo-csavarhuzo
- E Taladro-desarmador con acumulador

12V 1.5 Ah 24 Nm 0-350 min⁻¹ 0-1300 min⁻¹ 1-10 mm Li-Ion 1h QUICK CHARGING 1-10 mm WORK AREA LIGHTING OSWIETLENIE OBSZARU PRACY

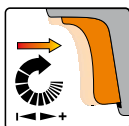

STHOR

$L_{pa} = 70,72 \pm 3,0$; $L_{wa} = 87,72 \pm 3,0$ dB; $a_n = 1,782 \pm 1,5$ m/s²

No.	V	min-1	Ø (mm)
78101	12	0-350 / 0-1300	1-10

- PL Młotowiertarka SDS plus
- GB Rotary hammer
- D Bohrhammer
- RUS Перфоратор
- CZ Vrtací kladivo
- RO Ciocan rotopercutor
- H Fúrókalapács
- E Martillo perforador

230V~50Hz 800 W 0-1000 min⁻¹ SDS PLUS 3.5I 30 mm 13 mm 24 mm

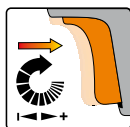

STHOR

$L_{pa} = 89,4 \pm 3,0$ dB; $L_{wa} = 100,4 \pm 3,0$ dB; $a_n = 14,936 \pm 1,5 / 14,898 \pm 1,5$ m/s²

No.	W	min-1	Ø (mm)
79053	800	0-1000	4

- PL Wkrętak akumulatorowy
- GB Cordless screwdriver
- D Akku-schrauber
- RUS Аккумуляторный шурупверт
- CZ Utahovák akumulatorový
- RO Şurubelniţă cu acumulator
- H Akkumulátoros csavarbehajtó
- E Herramienta de resistencia para soldar

3.6 V 1300 mAh Li-Ion 3.0 Nm 180 min⁻¹ LED CHARGE INDICATOR WSKAZNIK ŁADOWANIA



STHOR

No.	V	Ø (mm)
78150	3.6	20

- PL Akumulatorowa wiertarko-wkrętarka (tylko narzędzie)
- GB Cordless drill / driver (tool only)
- D Akkuschrauber-und-Bohrer (nur das Gerät)
- RUS Аккумуляторная дрель с шурупвертом (только инструмент)
- CZ Akumulatorový vrtací sroubovák (pouze nářadí)
- RO Maşina de găurit / înşurubat cu acumulator (numai sculă)
- H Akkus fúrócsavarozók (csak a szerszámot)
- E Taladro / atornillador a batería (herramienta solamente)

12V 1.5 Ah 24 Nm 0-350 min⁻¹ 0-1300 min⁻¹ 1-10 mm Li-Ion 1h QUICK CHARGING 1-10 mm WORK AREA LIGHTING OSWIETLENIE OBSZARU PRACY

Battery not included
Akumulatora nie dołączono

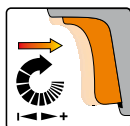

STHOR

$L_{pa} = 70,72 \pm 3,0$; $L_{wa} = 87,72 \pm 3,0$ dB; $a_n = 1,782 \pm 1,5$ m/s²

No.	V	min-1	Ø (mm)
78102	12	0-350 / 0-1300	1-10

- PL Wiertarko-wkrętarka akumulatorowa
- GB Cordless drill / driver
- D Akkuschrauber-und-Bohrer
- RUS Аккумуляторная дрель с шуруповертом
- CZ Akumulátorový vrtací šroubovák
- RO Bormasina-surubelnita cu acumulator
- H Akkumulátoros fúrócsavarhuzo
- E Taladro-desarmador con acumulador

12V	1.5 Ah	24 Nm
0-350 min ⁻¹ 0-1300 min ⁻¹	∅ 1-10mm	6.3mm 1/4"
Li-Ion	1h QUICK CHARGING Szybkie Ładowanie	
	WORK AREA LIGHTING OSWIETLENIE OBSZARU PRACY	

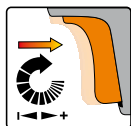

$L_{pA} = 70,72 \pm 3,0$ dB; $L_{wA} = 87,72 \pm 3,0$ dB; $a_n = 1,782 \pm 1,5$ m/s²

No.	V	min-1	∅ (mm)	
78105	12	0-350 / 0-1300	1-10	5

- PL Akumulatorowa wiertarko-wkrętarka udarowa
- GB Cordless impact drill / driver
- D Akku-Schlagbohrschrauber
- RUS Аккумуляторный ударный дрель-шуруповерт
- CZ Akumulátorový nárazový šroubovák s příklepem
- RO Mașină de găurit cu percuteție cu acumulator
- H Akkus ütvefűrógép
- E Taladro / atornillador con percusión a batería

12V	1.5 Ah	24 Nm
0-350 min ⁻¹ 0-1300 min ⁻¹	∅ 1-10mm	Li-Ion
1h QUICK CHARGING Szybkie Ładowanie		
	WORK AREA LIGHTING OSWIETLENIE OBSZARU PRACY	

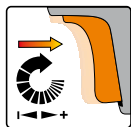

$L_{pA} = 82,2 \pm 3,0$ dB; $L_{wA} = 93,2 \pm 3,0$ dB; $a_n = 13,13 \pm 1,5 / 1,782 \pm 1,5$ m/s²

No.	V	min-1	∅ (mm)	
78110	12	0-350 / 0-1300	1-10	5

- PL Akumulatorowa wiertarko-wkrętarka (tylko narzędzie)
- GB Cordless drill / driver (tool only)
- D Akkuschrauber-und-Bohrer (nur das Gerät)
- RUS Аккумуляторная дрель с шуруповертом (только инструмент)
- CZ Akumulátorový vrtací šroubovák (pouze nářadí)
- RO Mașină de găurit / înșurubat cu acumulator (numai sculă)
- H Akkus fúrócsavarozók (csak a szerszámot)
- E Taladro / atornillador a batería (herramienta solamente)

12V	1.5 Ah	24 Nm
0-350 min ⁻¹ 0-1300 min ⁻¹	∅ 1-10mm	Li-Ion
1h QUICK CHARGING Szybkie Ładowanie		
	WORK AREA LIGHTING OSWIETLENIE OBSZARU PRACY	

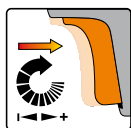

$L_{pA} = 82,2 \pm 3,0$ dB; $L_{wA} = 93,2 \pm 3,0$ dB; $a_n = 13,13 \pm 1,5 / 1,782 \pm 1,5$ m/s²

No.	V	min-1	∅ (mm)	
78112	12	0-350 / 0-1300	1-10	5

- PL Akumulatorowa wiertarko-wkrętarka (tylko narzędzie)
- GB Cordless drill / driver (tool only)
- D Akkuschrauber-und-Bohrer (nur das Gerät)
- RUS Аккумуляторная дрель с шуруповертом (только инструмент)
- CZ Akumulátorový vrtací šroubovák (pouze nářadí)
- RO Mașină de găurit / înșurubat cu acumulator (numai sculă)
- H Akkus fúrócsavarozók (csak a szerszámot)
- E Taladro / atornillador a batería (herramienta solamente)

12V	1.5 Ah	24 Nm
0-350 min ⁻¹ 0-1300 min ⁻¹	∅ 1-10mm	6.3mm 1/4"
Li-Ion	1h QUICK CHARGING Szybkie Ładowanie	
	WORK AREA LIGHTING OSWIETLENIE OBSZARU PRACY	

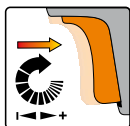

$L_{pA} = 70,72 \pm 3,0$ dB; $L_{wA} = 87,72 \pm 3,0$ dB; $a_n = 1,782 \pm 1,5$ m/s²

No.	V	min-1	∅ (mm)	
78106	12	0-350 / 0-1300	1-10	5

- PL Akumulatorowa wiertarko-wkrętarka udarowa
- GB Cordless impact drill / driver
- D Akku-Schlagbohrschrauber
- RUS Аккумуляторный ударный дрель-шуруповерт
- CZ Akumulátorový nárazový šroubovák s příklepem
- RO Mașină de găurit cu percuteție cu acumulator
- H Akkus ütvefűrógép
- E Taladro / atornillador con percusión a batería

12V	1.5 Ah	24 Nm
0-350 min ⁻¹ 0-1300 min ⁻¹	∅ 1-10mm	Li-Ion
1h QUICK CHARGING Szybkie Ładowanie		
	WORK AREA LIGHTING OSWIETLENIE OBSZARU PRACY	

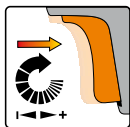

$L_{pA} = 82,2 \pm 3,0$ dB; $L_{wA} = 93,2 \pm 3,0$ dB; $a_n = 13,13 \pm 1,5 / 1,782 \pm 1,5$ m/s²

No.	V	min-1	∅ (mm)	
78111	12	0-350 / 0-1300	1-10	5

- PL Akumulatorowa zakrętkarka udarowa
- GB Cordless impact screwdriver
- D Akku-Schlagbohrschrauber
- RUS Аккумуляторный ударный гайковёрт
- CZ Akumulátorový rázový uťahovák
- RO Șurubelniță cu impact cu acumulator
- H Akkus ütvecsavarozó
- E Atornillador de impacto a batería

12V	1.5 Ah	110 Nm
0-2300 min ⁻¹	1/4"	Li-Ion
1h QUICK CHARGING Szybkie Ładowanie	6.3mm	
	WORK AREA LIGHTING OSWIETLENIE OBSZARU PRACY	

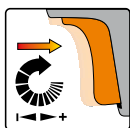

$L_{pA} = 70,76 \pm 3,0$ dB; $L_{wA} = 81,76 \pm 3,0$ dB; $a_n = 1,71 \pm 1,5$ m/s²

No.	V	min-1	
78115	12	0-2300	5

15

- PL Akumulatorowa zakreślarka udarowa (tylko narzędzie)
- GB Cordless impact screwdriver (tool only)
- D Akku-Schlagbohrschrauber (nur das Gerät)
- RUS Аккумуляторный ударный гайковёрт (только инструмент)
- CZ Akumulátorový rázový utahovák (pouze nářadí)
- RO Şurubelniţă cu impact cu acumulator (numai sculă)
- H Akkus ütvecsavarozó (csak a szerszámot)
- E Atornillador de impacto a batería (herramienta solamente)

12V 1.5 Ah 110 Nm

0-2300 min⁻¹ 1/4" 6.3mm Li-Ion

1h QUICK CHARGING SZYBKIE ŁADOWANIE

WORK AREA LIGHTING OSWIETLENIE OBSZARU PRACY



Battery not included
Akumulatora nie dołączono

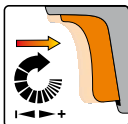

$L_{pA} = 70,76 \pm 3,0$ dB; $L_{wA} = 81,76 \pm 3,0$ dB; $a_n = 1,71 \pm 1,5$ m/s²

No.	V	min-1	
78116	12	0-2300	5

- PL Akumulatorowa wyrzynarka (tylko narzędzie)
- GB Cordless jig saw (tool only)
- D Akku-Stichsäge (nur das Gerät)
- RUS Аккумуляторная лобзиковая пила (только инструмент)
- CZ Akumulátorová přímočará píla (pouze nářadí)
- RO Akkus szűrőfűrész (csak a szerszámot)
- H Ferástráú vertical cu acumulator (numai sculă)
- E Sierra de calar a batería (herramienta solamente)

12V 1.5 Ah 2100 min⁻¹

Li-Ion 50mm 5 min⁻¹

1h QUICK CHARGING SZYBKIE ŁADOWANIE



Battery not included
Akumulatora nie dołączono

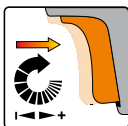

$L_{pA} = 88,2 \pm 3,0$ dB; $L_{wA} = 99,2 \pm 3,0$ dB; $a_n = 4,300 \pm 1,5 / 5,154 \pm 1,5$ m/s²

No.	V	min-1	
78122	12	2100	5

- PL Akumulatorowe wielofunkcyjne narzędzie oscylacyjne (tylko narzędzie)
- GB Cordless multi-purpose oscillating tool (tool only)
- D Akku-Multifunktionswerkzeug (nur das Gerät)
- RUS Аккумуляторный многофункциональный инструмент (только инструмент)
- CZ Akumulátorová multifunkční píla (pouze nářadí)
- RO Maşină multifuncţională cu acumulator (numai sculă)
- H Akkus multifunkcionális vágószerszám (csak a szerszámot)
- E Multiherramienta a batería (herramienta solamente)

12V 1.5 Ah 5000-18000 min⁻¹

Li-Ion 3.2mm 1h QUICK CHARGING SZYBKIE ŁADOWANIE



Battery not included
Akumulatora nie dołączono



$L_{pA} = 94,0 \pm 3,0$ dB; $L_{wA} = 105,0 \pm 3,0$ dB; $a_n = 11,240 \pm 1,5$ m/s²

No.	V	min-1	
78124	12	5000-18000	4

- PL Akumulatorowa wyrzynarka
- GB Cordless jig saw
- D Akku-Stichsäge
- RUS Аккумуляторная лобзиковая пила
- CZ Akumulátorová přímočará píla
- RO Akkus szűrőfűrész
- H Ferástráú vertical cu acumulator
- E Sierra de calar a batería

12V 1.5 Ah 2100 min⁻¹

Li-Ion 50mm 5 min⁻¹

1h QUICK CHARGING SZYBKIE ŁADOWANIE

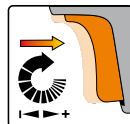

$L_{pA} = 88,2 \pm 3,0$ dB; $L_{wA} = 99,2 \pm 3,0$ dB; $a_n = 4,300 \pm 1,5 / 5,154 \pm 1,5$ m/s²

No.	V	min-1	
78121	12	2100	5

- PL Akumulatorowe wielofunkcyjne narzędzie oscylacyjne
- GB Cordless multi-purpose oscillating tool
- D Akku-Multifunktionswerkzeug
- RUS Аккумуляторный многофункциональный инструмент
- CZ Akumulátorová multifunkční píla
- RO Maşină multifuncţională cu acumulator
- H Akkus multifunkcionális vágószerszám
- E Multiherramienta a batería

12V 1.5 Ah 5000-18000 min⁻¹

Li-Ion 1h QUICK CHARGING SZYBKIE ŁADOWANIE



$L_{pA} = 94,0 \pm 3,0$ dB; $L_{wA} = 105,0 \pm 3,0$ dB; $a_n = 11,240 \pm 1,5$ m/s²

No.	V	min-1	
78123	12	5000-18000	5

- PL Akumulatorowa szlifierka wielofunkcyjna
- GB Cordless mini grinder
- D Akku-Mehrweckschleifmaschine
- RUS Аккумуляторный шлифовальная машина
- CZ Akumulátorová víceúčelová bruska
- RO Maşină de şlefuit multifuncţională cu acumulator
- H Akkus daugiafunkcis slifluoklis
- E Lijadora multifunción a batería

12V 40 pcs 1.5 Ah 5000-25000 min⁻¹

Li-Ion 3.2mm 1h QUICK CHARGING SZYBKIE ŁADOWANIE



$L_{pA} = 70,9 \pm 3,0$ dB; $L_{wA} = 81,9 \pm 3,0$ dB; $a_n = 34,25 \pm 1,5$ m/s²

No.	V	min-1	
78127	12	5000-25000	5

- PL Akumulatorowa szlifierka wielofunkcyjna (tylko narzędzie)
- GB Cordless mini grinder (tool only)
- D Akku- Mehrzweckschleifmaschine (nur das Gerät)
- RUS Аккумуляторный шлифовальная машина (только инструмент)
- CZ Akumulátorová víceúčelová bruska (pouze nářadí)
- RO Mașină de șlefuit multifuncțională cu acumulator (numai sculă)
- H Akkus dugiafunkcis slifukoklis (csak a szerszámot)
- E Lijadora multifunción a batería (herramienta solamente)

12V	40 pcs	1.5 Ah	
		1h	



Battery not included
Akumulatore nie dołączono

$L_{pA} = 70,9 \pm 3,0$ dB; $L_{wA} = 81,9 \pm 3,0$ dB; $a_n = 34,25 \pm 1,5$ m/s²

No.	V	min-1	
78128	12	5000-25000	5

- PL Wiertarko-wkrętarzka akumulatorowa
- GB Cordless drill
- D Akkuschauber
- RUS Аккумуляторная дрель-шурупверт
- CZ Vrtáčko-utahovák akumulátorový
- RO Bormașină-șurubelniță cu acumulator
- H Akkumulátoros fűrógép-csavarbehajtó
- E Taladradora - atornilladora acu.

10.8 V	1.3 Ah	0-700 min⁻¹	0.8-10 mm

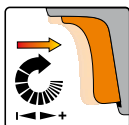

$L_{pA} = 89,0 \pm 3,0$ dB; $L_{wA} = 100,0 \pm 3,0$ dB; $a_n = 0,854 \pm 1,5 / 2,069 \pm 1,5$ m/s²

No.	V	min-1	Ø (mm)	
78981	10.8	0-700	0.8-10	5

- PL Wiertarko-wkrętarzka akumulatorowa
- GB Cordless drill
- D Akkuschauber
- RUS Аккумуляторная дрель-шурупверт
- CZ Vrtáčko-utahovák akumulátorový
- RO Bormașină-șurubelniță cu acumulator
- H Akkumulátoros fűrógép-csavarbehajtó
- E Taladradora - atornilladora acu.

18 V	1.3 Ah	0-700 min⁻¹	0.8-10 mm

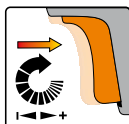

$L_{pA} = 89,0 \pm 3,0$ dB; $L_{wA} = 100,0 \pm 3,0$ dB; $a_n = 1,001 \pm 1,5 / 2,629 \pm 1,5$ m/s²

No.	V	min-1	Ø (mm)	
78983	18	0-700	0.8-10	5

- PL Akumulator
- GB Battery
- D Akkumulator
- RUS Аккумулятор
- CZ Akumulátor
- RO Acumulatorul
- H Akkumulátor
- E Acumulador

12V	
1.5 Ah	1h



No.	V	
78130	12	30

- PL Wiertarko-wkrętarzka akumulatorowa
- GB Cordless drill
- D Akkuschauber
- RUS Аккумуляторная дрель-шурупверт
- CZ Vrtáčko-utahovák akumulátorový
- RO Bormașină-șurubelniță cu acumulator
- H Akkumulátoros fűrógép-csavarbehajtó
- E Taladradora - atornilladora acu.

14.4 V	1.3 Ah	0-700 min⁻¹	0.8-10 mm

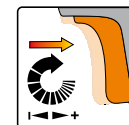

$L_{pA} = 87,0 \pm 3,0$ dB; $L_{wA} = 98,0 \pm 3,0$ dB; $a_n = 1,292 \pm 1,5 / 2,312 \pm 1,5$ m/s²

No.	V	min-1	Ø (mm)	
78982	14.4	0-700	0.8-10	5

- PL Akumulator
- GB Battery
- D Akkumulator
- RUS Аккумулятор
- CZ Akumulátor
- RO Acumulatorul
- H Akkumulátor
- E Acumulador

1.3 Ah		
---------------	--	--



No.	V	for / dia	
78985	10.8	78118; 78981	50
78986	14.4	78982	50
78987	18	78972; 78974; 78961; 78983	50

- PL Ładowarka
GB Battery charger
D Ladegerät
RUS Зарядное устройство
- CZ Nabíječka baterii
RO Redresor
H Akkumulátortöltő
E Rectificador



STHOR

No.	V	for / dla	Box
79087	15V ~ 400mA	79084	30
79088	18V ~ 400mA	79085	30
79089	24V ~ 400mA	79086	20

- PL Akumulatorowa wiertarko-wkrętarka udarowa
GB Cordless impact drill / driver
D Akku-Schlagbohrschrauber
RUS Аккумуляторный ударный дрель-шурупверт
CZ Akumulátorový nárazový šroubovák s príklepem
RO Mașină de găurit cu percucie cu acumulator
H Akkus ütvefűrógép
E Taladro / atornillador con percusión a batería

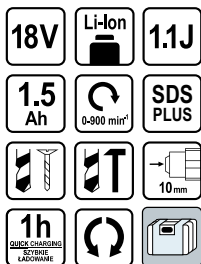

STHOR

$L_{pa} = 67,43 \pm 3,0 \text{ dB}$; $L_{wa} = 98,43 \pm 3,0 \text{ dB}$; $a_h = 12,48 \pm 1,5 \text{ m/s}^2$

No.	V	min-1	Box
78968	18	0-900	3

- PL Akumulatorowa wiertarko-wkrętarka udarowa
GB Cordless impact drill / driver
D Akku-Schlagbohrschrauber
RUS Аккумуляторный ударный дрель-шурупверт
CZ Akumulátorový nárazový šroubovák s príklepem
RO Mașină de găurit cu percucie cu acumulator
H Akkus ütvefűrógép
E Taladro / atornillador con percusión a batería

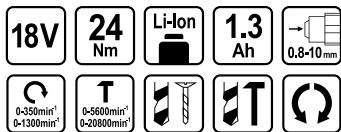

STHOR

$L_{pa} = 89,0 \pm 3,0 \text{ dB}$; $L_{wa} = 100,0 \pm 3,0 \text{ dB}$; $a_h = 15,25 \pm 1,5 \text{ m/s}^2$

No.	V	min-1	Box
78974	18	0-350; 0-1300	5

- PL Zakrętarła udarowa
GB Impact wrench
D Schlagschrauber
RUS Ударный гайковерт

- CZ Rázový šroubovák
RO Mașină de infilțat cu percucie
H Ütvecsavarozó
E Atornillador de impacto

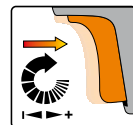

STHOR

$L_{pa} = 91,54 \pm 3,0 \text{ dB}$; $L_{wa} = 102,54 \pm 3,0 \text{ dB}$; $a_h = 51,45 \pm 1,5 \text{ m/s}^2$

No.	V	min-1	Box
78961	18	0-2300	5

- PL Wiertarko-wkrętarka akumulatorowa
GB Cordless drill / driver
D Akkuschauber-und-Bohrer
RUS Аккумуляторная дрель с шурупвертом
CZ Akumulátorový vrtací šroubovák
RO Bormasina-surubelnita cu acumulator
H Akkumulátoros furo-csavarhuzo
E Taladro-desarmador con acumulator

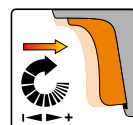
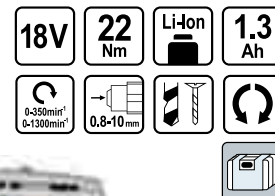

STHOR

$L_{pa} = 89,0 \pm 3,0 \text{ dB}$; $L_{wa} = 100,0 \pm 3,0 \text{ dB}$; $a_h = 1,001 \pm 1,5 / 2,629 \pm 1,5 \text{ m/s}^2$

No.	V	min-1	Box
78972	18	0-350; 0-1300	5

- PL Akumulatorowy pistolet do klejenia
GB Cordless glue gun
D Heissklebepistole
RUS Пистолет для клея
CZ Pistole na lepení
RO Pistol pentru lipit
H Ragasztópisztoly
E Pistola de cola



STHOR

No.	V	Box
78154	7.2	10

- PL Zszywacz akumulatorowy
- GB Cordless staples gun
- D Akku-Tacker
- RUS Аккумуляторный степлер
- CZ Akumulátorová sponkovačka
- RO Capsatorul cu acumulator
- H Akkus tűzőgép
- E Grapadora a batería



3.6V **1.3 Ah**

Li-Ion **30/min (max)**

Micro USB

$L_{pA} = 80,73 \pm 3,0$ dB; $L_{wA} = 91,73 \pm 3,0$ dB; $a_n = 2,628 \pm 1,5$ m/s²

No.	V	
78157	7.2	10

- PL Elektryczny klucz udarowy
- GB Electric impact wrench
- D Elektro-Schlagschrauber
- RUS Электрический гайковерт
- CZ Elektrický rázový uťahovák
- RO Cheie electrică
- H Elektromos ütvecsavarozó
- E llave de impacto eléctrica



230V~50Hz **800 W** **2200 min⁻¹** **325 Nm**

1/2" **17, 19 21, 22 mm**

12,5 mm

$L_{pA} = 87,5 \pm 3,0$ dB; $L_{wA} = 98,5 \pm 3,0$ dB; $a_n = 9,93 \pm 1,5$ m/s²

No.	W	min-1	
57091	800	2200	5

- PL Elektryczny klucz udarowy
- GB Electric impact wrench
- D Elektro-Schlagschrauber
- RUS Электрический гайковерт
- CZ Elektrický rázový uťahovák
- RO Cheie electrică
- H Elektromos ütvecsavarozó
- E llave de impacto eléctrica



230-240 V-50 Hz **1100 W** **2200 min⁻¹** **800 Nm**

3/4" **24, 30 32, 36 mm**

19 mm **4m**

$L_{pA} = 89,0 \pm 3,0$ dB; $L_{wA} = 100,0 \pm 3,0$ dB; $a_n = 10,04 \pm 1,6$ m/s²

No.	W	min-1	
57097	1100	2200	2

- PL Wiertarko-wkrętarzka sieciowa
- GB Electric drill / driver
- D Netzbohrschrauber
- RUS Сетевая дрель-шуруповерт
- CZ Síťová vrtačka / šroubovák
- RO Bormasina – surubelnita, de retea
- H Halozati furocsavarozó
- E Taladrado atornillador eléctrico

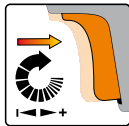

230V~50Hz **300 W**

I: 0-550 min⁻¹
II: 0-2100 min⁻¹

20 Nm **10 mm**

3.0m

21 + 1

$L_{pA} = 66,0 \pm 3,0$ dB; $L_{wA} = 77,0 \pm 3,0$ dB; $a_n = 2,53 \pm 1,5 / 0,78 \pm 1,5$ m/s²

No.	W	min-1	
78990	300	0-550 / 0-2100	10

- PL Elektryczny klucz udarowy
- GB Electric impact wrench
- D Elektro-Schlagschrauber
- RUS Электрический гайковерт
- CZ Elektrický rázový uťahovák
- RO Cheie electrică
- H Elektromos ütvecsavarozó
- E llave de impacto eléctrica



230-240V-50Hz **1100 W** **2200 min⁻¹** **450 Nm**

1/2" **17, 19 21, 22 mm**

12,5 mm **4m**

$L_{pA} = 89,0 \pm 3,0$ dB; $L_{wA} = 100,0 \pm 3,0$ dB; $a_n = 10,04 \pm 1,5$ m/s²

No.	W	min-1	
57092	1100	2200	2

- PL Szlifierka kątowa
- GB Angle grinder
- D Winkelschleifmaschine
- RUS Углошлифовальная машинка
- CZ Úhlová bruska
- RO Polizor unghiular
- H Sarokcsiszoló
- E Lijadera de angulo



230V~50Hz **600 W** **11000 min⁻¹**

115mm **M14**

$L_{pA} = 73 \pm 3$ dB; $L_{wA} = 84 \pm 3$ dB; $a_n = 3,19 \pm 1,5$ m/s²

No.	W	min-1	
79094	600	11000	8

- PL Szlifierka kątowa
- GB Angle grinder
- D Winkelschleifmaschine
- RUS Углошлифовальная машинка
- CZ Úhlová bruska
- RO Polizor unghiular
- H Sarokcsiszoló
- E Lijadera de angulo

230V~50Hz 710 W 11000min⁻¹

125 mm M14



$L_{pA} = 78 \pm 3$ dB; $L_{wA} = 89 \pm 3$ dB; $a_n = 3,84 \pm 1,5$ m/s²



No.	W	min-1	
79095	710	11000	8

- PL Szlifierka kątowa
- GB Angle grinder
- D Winkelschleifmaschine
- RUS Углошлифовальная машинка
- CZ Úhlová bruska
- RO Polizor unghiular
- H Sarokcsiszoló
- E Lijadera de angulo

230V~50Hz 2200 W 6500min⁻¹

230 mm M14





$L_{pA} = 97 \pm 3$ dB; $L_{wA} = 108 \pm 3$ dB; $a_n = 7,33 \pm 1,5$ m/s²



No.	W	min-1	
79151	2200	6500	2

- PL Szlifierka mimośrodowa
- GB Orbital sander
- D Exzentrische Schleifmaschine
- RUS Эксцентриковая шлифовальная машина
- CZ Excentrická bruska
- RO Polizor cu excentric
- H Excenter csiszoló
- E Pulidor excentrico

230V~50Hz 430 W 6000-13000min⁻¹ $\varnothing 125$ mm



$L_{pA} = 81,0 \pm 3,0$ dB; $L_{wA} = 92,0 \pm 3,0$ dB; $a_n = 10,8 \pm 1,5$ m/s²



No.	W	min-1	
79309	430	6000-13000	6

- PL Szlifierka kątowa
- GB Angle grinder
- D Winkelschleifmaschine
- RUS Углошлифовальная машинка
- CZ Úhlová bruska
- RO Polizor unghiular
- H Sarokcsiszoló
- E Lijadera de angulo

230V~50Hz 900 W 11000min⁻¹

125 mm M14



$L_{pA} = 87 \pm 3$ dB; $L_{wA} = 98 \pm 3$ dB; $a_n = 4,62 \pm 1,5$ m/s²



No.	W	min-1	
79119	900	11000	8

- PL Wielofunkcyjne narzędzie oscylacyjne
- GB Multi-purpose oscillating tool
- D Multifunktionales Oszillationswerkzeug
- RUS Многофункциональный инструмент
- CZ Multifunkční oscilační nářadí
- RO Unealtă multifuncțională oscilantă
- H Multifunkciós rezgő szerszám
- E Herramienta oscilatoria multiusos

230V~50Hz 220 W

15000-23000min⁻¹

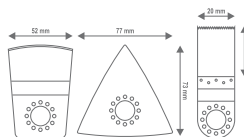
$L_{pA} = 89,4 \pm 3,0$ dB; $L_{wA} = 100,4 \pm 3,0$ dB; $a_n = 13,2 \pm 1,5$ m/s²



No.	W	min-1	
79240	220	15000-23000	10

- PL Szlifierka oscylacyjna
- GB Finishing sander
- D Schwingschleifer
- RUS Виброшлифмашина
- CZ Oscilační bruska
- RO Polizor oscilant
- H Vibrációs csiszológép
- E Lijadora de oscilación

230V~50Hz 135 W 10000min⁻¹



$L_{pA} = 84,0 \pm 3,0$ dB; $L_{wA} = 95,0 \pm 3,0$ dB; $a_n = 3,7 \pm 1,5$ m/s²



No.	W	min-1	
79491	135	10000	6

- PL Szlifierka taśmowa
- GB Belt sander
- D Bandschleifer
- RUS Ленточная шлифмашина
- CZ Pásová bruska
- RO Sac rumegus
- H Szalagcsiszológép
- E Maquina de pulir de banda

230V~
50Hz

950
W

200-380
m/min

53x76mm



STHOR

$L_{pA} = 85,6 \pm 3,0$ dB; $L_{wA} = 96,6 \pm 3,0$ dB; $a_s = 3,73 \pm 1,5$ m/s²

No.	W	m/min	Icon
79420	950	200-380	4

- PL Wyrzynarka
- GB Electric jig saw
- D Stichsäge
- RUS Лобзик электрический
- CZ Elektrická vyřezávací pila
- RO Fierastrau pendular
- H Elektromos dekopír fűrész
- E Cortadora electrica

230-240 V~
50 Hz

500
W

0-3000
min⁻¹

55 mm

6 mm

45°

U-TYPE BLADE
OSTRZE TYP-U

2,5m



STHOR

$L_{pA} = 87,4 \pm 3,0$ dB; $L_{wA} = 98,4 \pm 3,0$ dB; $a_s = 6,4 \pm 1,5 / 6,9 \pm 1,5$ m/s²

No.	W	min-1	Icon
79473	500	0-3000	10

- PL Wyrzynarka
- GB Electric jig saw
- D Stichsäge
- RUS Лобзик электрический
- CZ Elektrická vyřezávací pila
- RO Fierastrau pendular
- H Elektromos dekopír fűrész
- E Cortadora electrica

230-240 V~
50 Hz

650
W

0-3000
min⁻¹

65 mm

6 mm

45°

T-TYPE BLADE
OSTRZE TYP-T

2,5m



STHOR

$L_{pA} = 87,4 \pm 3,0$ dB; $L_{wA} = 98,4 \pm 3,0$ dB; $a_s = 6,4 \pm 1,5 / 6,9 \pm 1,5$ m/s²

No.	W	min-1	Icon
79474	650	0-3000	8

- PL Wyrzynarka
- GB Electric jig saw
- D Stichsäge
- RUS Лобзик электрический
- CZ Elektrická vyřezávací pila
- RO Fierastrau pendular
- H Elektromos dekopír fűrész
- E Cortadora electrica

230V~
50Hz

350
W

0-3000
min

45°

6 mm

55 mm

U-TYPE BLADE
OSTRZE TYP-U



STHOR

$L_{pA} = 90,0 \pm 3,0$ dB; $L_{wA} = 101,0 \pm 3,0$ dB; $a_s = 4,73 \pm 1,5 / 7,66 \pm 1,5$ m/s²

No.	W	min-1	Icon
79332	350	0-3000	10

- PL Wyrzynarka
- GB Electric jig saw
- D Stichsäge
- RUS Лобзик электрический
- CZ Elektrická vyřezávací pila
- RO Fierastrau pendular
- H Elektromos dekopír fűrész
- E Cortadora electrica

230V~
50Hz

570
W

0-3000
min⁻¹

45°

8 mm

65 mm

T-TYPE BLADE
OSTRZE TYP-T



STHOR

$L_{pA} = 90,0 \pm 3,0$ dB; $L_{wA} = 101,0 \pm 3,0$ dB; $a_s = 12,72 \pm 1,5 / 5,97 \pm 1,5$ m/s²

No.	W	min-1	Icon
79482	570	0-3000	10

- PL Wyrzynarka
- GB Electric jig saw
- D Stichsäge
- RUS Лобзик электрический
- CZ Elektrická vyřezávací pila
- RO Fierastrau pendular
- H Elektromos dekopír fűrész
- E Cortadora electrica

230-240 V~
50 Hz

850
W

0-3000
min⁻¹

100 mm

10 mm

45°

T-TYPE BLADE
OSTRZE TYP-T

LASER

3m



STHOR

$L_{pA} = 87,4 \pm 3,0$ dB; $L_{wA} = 98,4 \pm 3,0$ dB; $a_s = 6,4 \pm 1,5 / 6,9 \pm 1,5$ m/s²; Laser: 650 nm; ≤1 mW

No.	W	min-1	Icon
79476	850	0-3000	8

PL Opalarka
GB Hot air gun
D Heissluftpistole
RUS Фен технический

CZ Opalovací stroj
RO Pistol aer cald
H Hőlégfúvó tartozékokkal
E Secadora

230V~
50Hz

I - 1000W
II - 2000W

I - 350°C
II - 550°C



STHOR

No.	W	°C	
79320	1000-2000	350-550	10

PL Opalarka z akcesoriami
GB Hot air gun with accessories
D Heissluftpistole
RUS Фен технический в наборе

CZ Opalovací stroj w s příslušenstvím
RO Fion cu accesorii pt. ars vopseaua
H Hőlégfúvó tartozékokkal
E Secadora con accesorios

230V~
50Hz

I - 1000W
II - 1500W

I - 300°C
II - 500°C



STHOR

No.	W	°C	
79328	1000-1500	300-500	5

PL Pistolet do klejenia
GB Electric glue gun
D Heissklebepistole
RUS Пистолет для клея

CZ Pistole na lepení
RO Pistol pt. lipit
H Ragasztópisztoly
E Pistola de cola

230V~
50Hz

14-16
g/min

200
°C

23(80)
W

3-5
min

2x
Ø11mm



STHOR

No.	W	diameter of glue stick / średnica wkładu (mm)	capacity / wydajność (g / min)	
73057	23 (80)	11	15	6/48

PL Opalarka
GB Hot air gun
D Heissluftpistole
RUS Фен технический

CZ Opalovací stroj
RO Pistol aer cald
H Hőlégfúvó tartozékokkal
E Secadora

230V~
50Hz

I - 1000W
II - 1500W

I - 300°C
II - 500°C



STHOR

No.	W	°C	
79327	1000-1500	300-500	10

PL Pistolet do klejenia
GB Electric glue gun
D Heissklebepistole
RUS Пистолет для клея

CZ Pistole na lepení
RO Pistol pt. lipit
H Ragasztópisztoly
E Pistola de cola

230V~
50Hz

8-12
g/min

200
°C

15(40)
W

3-5
min

2x
Ø11mm



STHOR

No.	W	diameter of glue stick / średnica wkładu (mm)	capacity / wydajność (g / min)	
73056	15 (40)	11	12	6/48

PL Pistolet do klejenia
GB Electric glue gun
D Heissklebepistole
RUS Пистолет для клея

CZ Pistole na lepení
RO Pistol pt. lipit
H Ragasztópisztoly
E Pistola de cola

230V~
50Hz

15
g/min

180-200
°C

15(100)
W

3-6
min

2x
Ø11mm



STHOR

No.	W	diameter of glue stick / średnica wkładu (mm)	capacity / wydajność (g / min)	
73052	15 (100)	11	16	12/48

PL Elektryczny pistolet natryskowy
GB Electric spray gun
D Elektro Farbspritzpistole
RUS Электрический пульверизатор

CZ Elektrická pistole maliřská
RO Pistol de vopșit - electric
H Elektromos festekszoro pisztolyę
E Pistola de pintat electr.

230V~
50Hz

60
W

0.24
l/min

800
ml

HVLP



STHOR

No.	W	
79766	60	5

$L_{pA} = 86,57 \pm 3,0$ dB; $L_{wA} = 97,57 \pm 3,0$ dB; $a_s = 10,46 \pm 1,5$ m/s²

PL Odkurzacz przemysłowy CZ Průmyslový vysavač
 GB Industrial vacuum cleaner RO Aspirator industrial
 D Industriesauger H Ipari porszívó
 RUS Пылесос промышленный E Aspirador industria



230V~50Hz 1600 W 30l
 16 kPa IPX4
 POWER SOCKET GNAZDO ZASLAJACE WET AND DRY SUCHO MOKRO
 BLOW FUNCTION FUNKCJA DMUCHAWY

No.	W	
78873	1600	1

PL Stacja lutownicza CZ Letovací stanice
 GB Soldering station RO Stație de lipit
 D Lötstation H Forrasztópáka állomás
 RUS Паяльная станция E Estación de soldadura



230V~50Hz 40 W
 150÷420 °C 4.7 mm

No.	W	
79376	40	12

PL Lutownica transformatorowa CZ Transformátorová páječka
 GB Transformer soldering gun RO Pistol de lipit + accesorii
 D Lötstation H Forrasztópáka
 RUS Паяльник электрический E Soldador transformador



230V~50Hz 100 W

No.	W	
79354	100	10

PL Lutownica oporowa CZ Pájka odporová
 GB Soldering iron RO Ciocan de lipit
 D Delötkolben H Huforrasztópáka
 RUS Электропаяльник E Soldador de resistencia

230V~50Hz 400°C 5-10 min



No.	W	
79365	30	25/50
79366	40	25/50
79367	60	25/50
79368	80	25/50

PL Komplet grotów do stacji lutowniczej CZ Hrot do letovačky
 GB Spare soldering tips RO Vârf pt. ciocanul de lipit
 D Lötspitze H Pákahegy
 RUS Наконечник паяльника E Pico soldador

3 pcs 40 W
 4.7 mm 56.5 mm
 420 °C for/dla: 79376



No.	W	pcs	R	for / dla	
79377	40	3	0.4; 0.8; 1.2	79376	600
79378	40	3	1.6; 1.6; 3.2	79376	600

PL Mieszarka do zapraw GB Hand mixer
 D Mörtelmischgerät
 RUS Растворомешалка
 CZ Ruční míchačka na maltu
 RO Malaxor pt. mortar
 H Habarcskeverő
 E Mezcladora de mortero

220-240V~50/60Hz 1200 W 0-680 min⁻¹ 120 mm
 M14

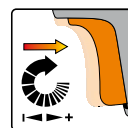

$L_{pA} = 92 \pm 3 \text{ dB}$; $L_{wA} = 103 \pm 3 \text{ dB}$; $a_n = 2,874 \pm 1,5 \text{ m/s}^2$

No.	W	min ⁻¹	
78854	1200	0 - 680	2

PL Szlifierka stolowa
GB Bench grinder
D Doppelschleifmaschine
RUS Станок точильный

CZ Stolní bruska
RO Polizor de banc
H Asztali kőszűrő
E Lijadera de mesa

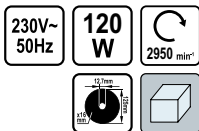

STHOR

$L_{pa} = 63,0 \pm 3,0$ dB; $L_{wa} = 76,0 \pm 3,0$ dB

No.	W	min-1	
79205	120	2950	1

PL Szlifierka stolowa
GB Bench grinder
D Doppelschleifmaschine
RUS Станок точильный

CZ Stolní bruska
RO Polizor de banc
H Asztali kőszűrő
E Lijadera de mesa

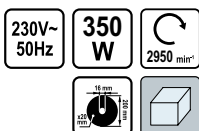

STHOR

$L_{pa} = 63,0 \pm 3,0$ dB; $L_{wa} = 76,0 \pm 3,0$ dB

No.	W	min-1	
79207	350	2950	1

PL Pompa zatapialna do wody brudnej
GB Dirty water submersible pump
D Tauchmotorpumpe
RUS Погружной насос
CZ Zatahovací čerpadlo
RO Pompă pt. apă murdară
H Búvárszivattyú
E Bomba de inmersión para agua sucia



STHOR

No.	W	l/h	H (max)	
79781	400	8000	5.5	4
79782	500	10000	6.5	4
79783	600	11500	7.0	4

PL Szlifierka stolowa
GB Bench grinder
D Doppelschleifmaschine
RUS Станок точильный

CZ Stolní bruska
RO Polizor de banc
H Asztali kőszűrő
E Lijadera de mesa

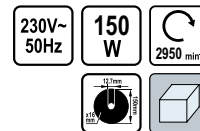

STHOR

$L_{pa} = 63,0 \pm 3,0$ dB; $L_{wa} = 76,0 \pm 3,0$ dB

No.	W	min-1	
79206	150	2950	1

PL Zgrzewarka do rur termoplastycznych
GB PVC plastic pipe welder
D Schweissgerät für thermoplastische Rohre
RUS Сварочная машина для термопластиковых труб
CZ Svářečka na termoplastické trubky
RO Hegeşto berendezés termoplastikus csövekhez
H Masina de sudat tevi termoplastice
E Maquina de soldar las tubos termoplasticos

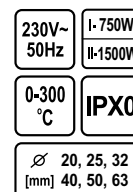

STHOR

No.	W	
78912	750-1500	4

PL Pompa membranowa zatapialna
GB Membrane deep well water pump
D Tauchmotorpumpe
RUS Погружной насос
CZ Zatahovací čerpadlo
RO Pompă pt. apă cu membrana
H Búvárszivattyú
E Bomba de diafragma sumergible



STHOR

No.	W	l / h	H max (m)	
79943	280	1020	68	4

PL Wiertarka udarowa
GB Impact drill
D Schlagbohrmaschine
RUS Дрель ударная
CZ Nárazová vrtačka
RO Masina de gaurit
H Kezelési utasítás
E Taladradora de percusión

230V~50Hz 750 W 13mm 0-3000 min⁻¹



LUND

$L_{pA} = 78,0 \pm 3,0$ dB; $L_{wA} = 89,0 \pm 3,0$ dB; $a_n = 2,93 \pm 1,5 / 8,43 \pm 1,5$ m/s²

No.	W	min-1	
79015	750	0-3000	10

PL Szlifierka kątowa
GB Angle grinder
D Winkelschleifmaschine
RUS Углошлифовальная машина
CZ Úhlová bruska
RO Polizor unghiular
H Sarokcsiszoló
E Lijadera de angulo

230V~50Hz 2200 W 6300 min⁻¹

230 mm M14



LUND

$L_{pA} = 96,0 \pm 3,0$ dB; $L_{wA} = 107,0 \pm 3,0$ dB; $a_n = 6,49 \pm 1,5$ m/s²

No.	W	min-1	
79150	2200	6300	4

PL Szlifierka oscylacyjna
GB Finishing sander
D Schwingschleifer
RUS Виброшлифмашина
CZ Oscilační bruska
RO Polizor oscilant
H Vibrációs csiszológép
E Lijadora de oscilación

230V~50Hz 135 W 11000 min⁻¹



LUND

$L_{pA} = 79,7 \pm 3,0$ dB; $L_{wA} = 90,7 \pm 3,0$ dB; $a_n = 6,140 \pm 1,5 / 7,629 \pm 1,5$ m/s²

No.	W	min-1	
79493	135	11000	10

PL Młot udarowy
GB Rotary hammer
D Bohrhämmer
RUS Перфоратор
CZ Pěráčecí kladivo
RO Ciocan percutatnt
H Fúrőkalapács-gép
E Martillo de percusión

230V~50Hz 1050 W 900 min⁻¹ 4.5J SDS PLUS



LUND

$L_{pA} = 92,3 \pm 3,0$ dB; $L_{wA} = 103,3 \pm 3,0$ dB; $a_n = 12,730 \pm 1,5$ m/s²

No.	W	min-1	
79046	1050	900	2

PL Uniwersalna szlifierka wielofunkcyjna
GB Mini grinder
D Universal-Mehrzweckschleifmaschine
RUS Универсальная шлифовальная машина
CZ Viceúčelová univerzální bruska
RO Maşina de şlefuit universală multifuncţională
H Universalus daugiafunkcis šifuoķlis
E Lijadora multifunci3n

230V~50Hz 135 W 40 pcs

10000-35000 min⁻¹ 2,3, 3,2 20mm



LUND

$L_{pA} = 75,7 \pm 3,0$ dB; $L_{wA} = 86,7 \pm 3,0$ dB; $a_n = 2,397 \pm 1,5 / 1,739 \pm 1,5$ m/s²

No.	W	min-1	
79314	135	10000-35000	10

PL Polerka samochodowa
GB Car polisher
D Autopoliermaschine
RUS Полировальная машинка
CZ Leštička na automobily
RO Masina de lustruit automobile
H Gépkocsi polírozógép
E Maquina para pulir coches

230V~50Hz 120 W 3200 min⁻¹



LUND

$L_{pA} = 58,0 \pm 3,0$ dB; $L_{wA} = 69,0 \pm 3,0$ dB; $a_n = 14,8 \pm 1,5$ m/s²

No.	W	min-1	
82942	120	3200	6

- PL Wyrzynarka
- GB Electric jig saw
- D Stichsäge
- RUS Лобзик электрический
- CZ Elektrická vyřezávací pila
- RO Fierastrau pendular
- H Elektromos dekopír fűrész
- E Cortadora electrica

U-TYPE BLADE
OSTRZE TYP-U

230V~
50Hz

450
W

0-3000
min⁻¹

45°

55
mm

6
mm

⚙️

⊠️

📦



$L_{PA} = 84,0 \pm 3,0$ dB; $L_{WA} = 95,0 \pm 3,0$ dB; $a_h = 7,33 \pm 1,5 / 4,40 \pm 1,5$ m/s²

No.	W	min-1	📦
79479	450	0-3000	10

- PL Pilarka ręczna
- GB Circular saw
- D Handkreissäge
- RUS Пила циркулярная ручная
- CZ Pila kotoučová
- RO Fierastrau circular
- H Kézi körfűrészgép
- E Sierra de disco

230V~
50Hz

1400
W

4500
min⁻¹

0-45°

54
mm

22 (mm)
160x20x2,8

18T

⊠️

📦



$L_{PA} = 101,8 \pm 3,0$ dB; $L_{WA} = 112,8 \pm 3,0$ dB; $a_h = 3,981 \pm 1,5 / 4,492 \pm 1,5$ m/s²

No.	W	min-1	📦
79334	1400	4500	4

- PL Opalarka z akcesoriami
- CZ Opalovací stroj w s příslušenstvím
- GB Hot air gun with accessories
- RO Fion cu accesorii pt. ars vopsea
- D Heissluftpistole
- H Hőlégfúvó tartozékokkal
- RUS Фен технический в наборе
- E Secadora con accesorios

230V~
50Hz

I-1000W
II-2000W

I-350°C
II-550°C

⊠️

📦



No.	W	°C	📦
79325	1000-2000	350-550	10

- PL Wyrzynarka
- GB Electric jig saw
- D Stichsäge
- RUS Лобзик электрический
- CZ Elektrická vyřezávací pila
- RO Fierastrau pendular
- H Elektromos dekopír fűrész
- E Cortadora electrica

U-TYPE BLADE
OSTRZE TYP-U

230V~
50Hz

650
W

0-3000
min⁻¹

45°

65
mm

6
mm

⚙️

⊠️

📦



$L_{PA} = 90,0 \pm 3,0$ dB; $L_{WA} = 101,0 \pm 3,0$ dB; $a_h = 7,66 \pm 1,5 / 4,73 \pm 1,5$ m/s²

No.	W	min-1	📦
79481	650	0-3000	10

- PL Opalarka
- CZ Opalovací stroj
- GB Hot air gun
- RO Pistol aer cald
- D Heissluftpistole
- H Hőlégfúvó tartozékokkal
- RUS Фен технический
- E Secadora

230V~
50Hz

I-1000W
II-2000W

I-350°C
II-550°C

⊠️

📦



No.	W	°C	📦
79324	750-1500	300-500	10

- PL Opalarka z akcesoriami
- CZ Opalovací stroj w s příslušenstvím
- GB Hot air gun with accessories
- RO Fion cu accesorii pt. ars vopsea
- D Heissluftpistole
- H Hőlégfúvó tartozékokkal
- RUS Фен технический в наборе
- E Secadora con accesorios

230V~
50Hz

I-1000W
II-2000W

I-350°C
II-550°C

⊠️

📦



No.	W	°C	📦
79318	1000-2000	350-550	10

PL Pistolet do klejenia
GB Electric glue gun
D Heissklebepistole
RUS Пистолет для клея

CZ Pistole na lepení
RO Pistol pt. lipit
H Ragasztópisztoly
E Pistola de cola

230V~ 50Hz	4.5 g/min	160-180 °C	8(30) W
3-6 min	2x ∅7mm		



LUND

No.	W	diameter of glue stick / średnica wkładu (mm)	capacity / wydajność (g / min)	
73040	8 (30)	7	4.5	12/48

PL Pistolet do klejenia
GB Electric glue gun
D Heissklebepistole
RUS Пистолет для клея

CZ Pistole na lepení
RO Pistol pt. lipit
H Ragasztópisztoly
E Pistola de cola

230V~ 50Hz	11 g/min	200 °C	16W
3-5 min	∅11 mm		



LUND

No.	W	diameter of glue stick / średnica wkładu (mm)	capacity / wydajność (g / min)	
73060	16	11	11	10

PL Lutownica oporowa
GB Soldering iron
D DelötKolben
RUS Электропаяльник

CZ Pájka odporová
RO Ciocan de lipit
H Huforrasztópáka
E Soldador de resistencia

230V~ 50Hz	100 W	400°C
5-10 min	∅8 mm	



LUND

No.	W	∅ (mm)	
79385	100	8	25/50

PL Pistolet do klejenia
GB Electric glue gun
D Heissklebepistole
RUS Пистолет для клея

CZ Pistole na lepení
RO Pistol pt. lipit
H Ragasztópisztoly
E Pistola de cola

110-240V~ 50Hz	7 g/min	190-210 °C	12(72) W
3-5 min	2x ∅11mm		



LUND

No.	W	diameter of glue stick / średnica wkładu (mm)	capacity / wydajność (g / min)	
73051	12 (72)	11	7	12/48

PL Lutownica oporowa
GB Soldering iron
D DelötKolben
RUS Электропаяльник

CZ Pájka odporová
RO Ciocan de lipit
H Huforrasztópáka
E Soldador de resistencia

230V~ 50Hz	400°C
5-10 min	



LUND

No.	W	∅ (mm)	
79382	40	5	25/50
79383	60	6	25/50

PL Stacja lutownicza
GB Soldering station
D Lötstation
RUS Паяльная станция

CZ Letovací stanice
RO Stație de lipit
H Forrasztópáka állomás
E Estación de soldadura

230V~ 50Hz	40 W	150-420 °C
2x ∅3.8mm		



LUND

No.	W	
79373	40	20

PL Komplet grotów do stacji lutowniczej
 GB Spare soldering tips
 D Lötspitze
 RUS Наконечник паяльника

CZ Hrot do letovačky
 RO Vârf pt. ciocanul de lipit
 H Pákahegy
 E Pico soldador

2 pcs	R1.0 mm 4.2 mm	∅3.8 mm 25.5 mm
40 W	420 °C	for/dla: 79373



LUND

No.	W	pcs	for / dla	
79374	40	2	79373	1000

PL Zgrzewarka do rur termoplastycznych
 GB PVC plastic pipe welder
 D Schweissgerät für thermoplastische Rohre
 RUS Сварочная машина для термопластиковых труб
 CZ Svářečka na termoplastické trubky
 RO Hegesztő berendezés termoplasztikus csövekhez
 H Masina de sudat tevi termoplastice
 E Maquina de soldar las tubos termoplasticos



LUND

No.	W	
78911	800	5

PL Lutownica transformatorowa
 GB Transformer soldering gun
 D Löt pistol
 RUS Паяльник электрический

CZ Transformátorová páječka
 RO Pistol de lipit + accesorii
 H Forrasztópáka
 E Soldador transformador

230V~ 50Hz	100 W



LUND

No.	W	
79355	100	10

230V~ 50Hz	800 W
0-300 °C	IPX4
∅ 16, 20, 25 [mm] 32, 40, 50	

																																																																																															Memo				

- PL Akumulatorowe nożyce do trawy i krzewów
- GB Cordless grass and shrub shears
- D Akkuscherer mit Gras- und Strauchmesser
- RUS Аккумуляторные ножницы для травы и кустов
- CZ Akumulátorové nůžky na trávu a keře
- RO Trimmer cu acumulator pt. iarba si gard viu
- H Foarfecele cu acumulator pt. tăiat iarba
- E Tijeras a batería para hierba y arbustos

3.6 V
1.3 Ah
Li-Ion

1000 min⁻¹

Li-Ion

80 mm

2in1

110 mm



$L_{pa} = 74,6 \pm 3,0$ dB; $L_{wa} = 86,4 \pm 3,0$ dB; $a_n = 1,63 \pm 1,5$ m/s²

No.	min-1	
79500	1000	8

- PL Akumulatorowa podkaszarka do trawy
- GB Cordless grass trimmer
- D Akku-Rasentrimmer
- RUS Аккумуляторные триммеры
- CZ Akumulátorová sekačka na trávu
- RO Trimmere de gazon cu acumulator
- H Akkus szegélynyíró
- E Desmalezadora inalámbrica

18 V

1.5 Ah

27 Wh

8000 min⁻¹

Li-Ion

TAPÉGO SPOOL HEAD TYPE
GLOMCA TYPU
TAPÉGO

230 mm

CHARGE LEVEL INDICATOR
WEKAZNIK STANU NAŁADOWANIA BATERII



$L_{pa} = 72,4 \pm 3,0$ dB; $L_{wa} = 87,37 \pm 3,0$ dB; $a_n = 1,45 \pm 1,5$ m/s²

No.	V	min-1	Ø (mm)	
79510	18	8000	230	2

- PL Akumulator
- GB Battery
- D Akkumulator
- RUS Аккумулятор
- CZ Akumulátor
- RO Acumulatorul
- H Akkumulátor
- E Acumulador

18 V

1.5 Ah

27 Wh

Li-Ion

CHARGE LEVEL INDICATOR
WEKAZNIK STANU NAŁADOWANIA BATERII

for/dla:
79510
79520



No.	V	for / dla	
79530	18	79510; 79520	25

- PL Akumulatorowe nożyce do trawy i krzewów
- GB Cordless grass and shrub shears
- D Akkuscherer mit Gras- und Strauchmesser
- RUS Аккумуляторные ножницы для травы и кустов
- CZ Akumulátorové nůžky na trávu a keře
- RO Trimmer cu acumulator pt. iarba si gard viu
- H Foarfecele cu acumulator pt. tăiat iarba
- E Tijeras a batería para hierba y arbustos

3.6 V
1.3 Ah
Li-Ion

1000 min⁻¹

Li-Ion

80 mm

2in1

110 mm



$L_{pa} = 74,6 \pm 3,0$ dB; $L_{wa} = 86,4 \pm 3,0$ dB; $a_n = 1,63 \pm 1,5$ m/s²

No.	min-1	
79501	1000	8

- PL Akumulatorowe nożyce do żywoplotu
- GB Cordless hedge trimmer
- D Akku-Heckenschere
- RUS Аккумуляторный кусторез
- CZ Akumulátorové nůžky na živé ploty
- RO Akkus sövénynyíró
- H Foarfecele de tăiat gard viu cu acumulator
- E Cortasetos inalámbrico

18 V

1.5 Ah

27 Wh

1100 min⁻¹

Li-Ion

440mm

CHARGE LEVEL INDICATOR
WEKAZNIK STANU NAŁADOWANIA BATERII



$L_{pa} = 75,19 \pm 3,0$ dB; $L_{wa} = 86,19 \pm 3,0$ dB; $a_n = 0,933 \pm 1,5$ m/s²

No.	V	min-1	L (mm)	
79520	18	1100	440	2

- PL Ładowarka do akumulatora
- GB Battery charger
- D Ladegerät
- RUS Зарядное устройство
- CZ Nabíječka
- RO Redresor
- H Akkutöltő
- E Rectificador

230V~
50Hz

for/dla:
18V

Li-Ion

for/dla:
79510
79520
79530



No.	V	for / dla	
79531	18	79510; 79520; 79530	25

PL Pompa zatapialna do wody brudnej
 GB Dirty water submersible pump
 D Tauchmotorpumpe
 RUS Погружной насос
 CZ Zátavovací čerpadlo
 RO Pompă pt. apă murdară
 H Búvárszivattyú
 E Bomba de inmersión para agua sucia

230V~
50Hz

1"
25mm

5/4"
32mm

1.5"
38mm



No.	W	l / h	H (max)	
79771	400	10000	6.5	4
79772	550	11500	7.0	4
79773	750	14000	7.5	4
79774	900	16000	8.5	4
79775	1100	16000	8.5	4

PL Pompa zatapialna do wody brudnej i ścieków
 GB Submersible pump for dirty water and wastewater
 D Tauchpumpe für Schmutzwasser
 RUS Погружной насос для грязной воды
 CZ Ponorové čerpadlo pro odpadní vody
 RO Pompă submersibilă pt. apă uzată
 H Búvárszivattyú szennyvíz
 E Bomba sumergible para aguas residuales

230V~
50Hz

450
W



No.	W	l / h	H (max)	
79880	450	16000	9	1

PL Pompa ogrodowa
 GB Jet pump
 D Gartenpumpe
 RUS Насос садовый

CZ Zahradní čerpadlo
 RO Pompa apa
 H Kerti szivattyúhoz
 E Bomba de jardín con cabeza



No.	W	l / h	H (max)	max. pressure / max. ciśnienie (bar)	
79810	600	2800	35	3.5	1
79811	800	3600	40	4.0	1
79812	1000	3800	44	4.4	1

PL Pompa zatapialna do wody brudnej
 GB Dirty water submersible pump
 D Tauchmotorpumpe
 RUS Погружной насос
 CZ Zátavovací čerpadlo
 RO Pompă pt. apă murdară
 H Búvárszivattyú
 E Bomba de inmersión para agua sucia

230V~
50Hz

1"
25mm

5/4"
32mm

1.5"
38mm



No.	W	l / h	H (max)	
79790	750	14000	7.5	2
79791	900	16000	8.5	2
79792	1100	20000	9.0	2

PL Pompa ogrodowa
 GB Jet pump
 D Gartenpumpe
 RUS Насос садовый

CZ Zahradní čerpadlo
 RO Pompa apa
 H Kerti szivattyúhoz
 E Bomba de jardín con cabeza

230V~
50Hz



$L_{wa} = 95 \pm 3$ dB

No.	W	l / h	H (max)	max. pressure / max. ciśnienie (bar)	
79912	600	2800	35	3.5	1
79913	800	3200	40	4.0	1

230V~
50Hz



$L_{wa} = 95 \pm 3$ dB

PL Pompa fontanna
 GB Fountain pump
 D Springbrunnenpumpe
 RUS Фонтанный насос
 CZ Fontánová pumpa
 RO Pompa pt. fantana arteziana
 H Pumpa szökőkúthoz
 E Bomba para las fuentes

230V~50Hz 3 NOZZLES DYSZE IPX8



No.	W	l / h	H (max)	☐
79926	8	600	1.0	12
79927	16	800	1.3	12
79928	22	1000	1.6	12

PL Pompa fontanna
 GB Fountain pump
 D Springbrunnenpumpe
 RUS Фонтанный насос
 CZ Fontánová pumpa
 RO Pompa pt. fantana arteziana
 H Pumpa szökőkúthoz
 E Bomba para las fuentes

230V~50Hz

CABLE 10m

IP68

5 NOZZLES



No.	W	l / h	H (max)	☐
79931	55	2000	2.5	8
79932	85	3000	3.5	8
79933	100	4500	4.5	6

PL Pompa fontanna
 GB Fountain pump
 D Springbrunnenpumpe
 RUS Фонтанный насос
 CZ Fontánová pumpa
 RO Pompa pt. fantana arteziana
 H Pumpa szökőkúthoz
 E Bomba para las fuentes

230V~50Hz 5 NOZZLES DYSZE IPX8



No.	W	l / h	H (max)	☐
79929	28	1400	2.0	8
79930	40	1800	2.5	8

PL Podkaszarka elektryczna
 GB Electric trimmer
 D Elektro-Rasentrimmer
 RUS Электрический триммер
 CZ Elektrická sekačka
 RO Cositoare electrică
 H Elektromos fűnyíró
 E Segadora eléctrica

230V~50Hz 500 W

10500 min⁻¹ 280 mm

↑100 cm ↓80 cm 2 POSITIONS POZYCJE



No.	W	min ⁻¹	Ø (mm)	☐
79467	500	10500	280	4

$L_{pA} = 83,2 \pm 3,0$ dB; $L_{wA} = 94,1 \pm 1,94$ dB; $a_b = 0,794 \pm 1,5$ m/s²

- PL Elektryczne nożyce do żywoplotu
- GB Hedge shears
- D Heckenscheren
- RUS Ножницы для живой изгороди
- CZ Nůžky na živý plot
- RO Foarfece pt. gard viu
- H Sövénnyvágó olló
- E Tijera para vallado

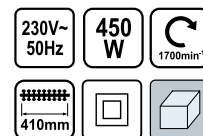

No.	W	min-1	L (mm)	
79442	450	1700	410	4

 $L_{pA} = 81,6 \pm 3,0 \text{ dB}; L_{wA} = 101,6 \pm 3,0 \text{ dB}; a_{p1} = 5,328 \pm 1,5 / 6,1214 \pm 1,5 \text{ m/s}^2$

- PL Nożyce do żywoplotu
- GB Hedge shears
- D Heckenscheren
- RUS Ножницы для живой изгороди
- CZ Nůžky na živý plot
- RO Foarfece pt. gard viu
- H Sövénnyvágó olló
- E Tijera para vallado



No.	W	min-1	L (mm)	
79444	520	1600	510	4

 $L_{pA} = 81,2 \pm 1,8 \text{ dB}; L_{wA} = 101,2 \pm 1,8 \text{ dB}; a_{p1} = 2,840 \pm 1,5 \text{ m/s}^2$

- PL Nożyce do żywoplotu
- GB Hedge shears
- D Heckenscheren
- RUS Ножницы для живой изгороди
- CZ Nůžky na živý plot
- RO Foarfece pt. gard viu
- H Sövénnyvágó olló
- E Tijera para vallado



No.	W	min-1	L (mm)	
79448	550	1700	510	4

 $L_{pA} = 78,58 \pm 1,489 \text{ dB}; L_{wA} = 98,54 \pm 1,489 \text{ dB}; a_{p1} = 3,272 \pm 1,5 / 3,435 \pm 1,5 \text{ m/s}^2$

Memo	
------	--

PL Odkurzacz przemysłowy CZ Průmyslový vysavač
 GB Industrial vacuum cleaner RO Aspirator industrial
 D Industriesauger H Ipari porszívó
 RUS Пылесос промышленный E Aspirador industria



230V~50Hz 1000 W 20l
 17 kPa IP24
 BLOW FUNCTION FUNKCIA DMUCHAWY WET AND DRY SUCHO MOKRO

No.	W	
78871	1000	1

PL Lutownica transformatorowa CZ Transformátorová páječka
 GB Transformer soldering gun RO Pistol de lipit
 D Lötspistole H Forrasztópáka
 RUS Паяльник электрический E Soldador transformador

230V~50Hz 100 W



No.	W	
79350	100	24

PL Glowica żyłkowa GB Line head
 D Trimmerkopf
 RUS Головка с леской CZ Strunová hlava
 RO Cap cu cablu H Damil fej
 E Cabezal de hilo

2.0-2.4 mm M10x1.25L +4 ADAPTER <30 cm²



No.	Ø (mm)	
79550	2.0-2.4	10/40

PL Lutownica pistoletowa CZ Pájka odporová
 GB Soldering iron RO Ciocan de lipit
 D Delötkolben H Huforrasztópáka
 RUS Электропаяльник E Soldador de resistencia

230V~50Hz 40 W
 420°C 3.8 mm 70 mm



No.	W	
79358	40	25/50

PL Lutownica transformatorowa CZ Transformátorová páječka
 GB Transformer soldering gun RO Pistol de lipit
 D Lötspistole H Forrasztópáka
 RUS Паяльник электрический E Soldador transformador

230V~50Hz 100 W



No.	W	
79351	100	10

PL Glowica żyłkowa GB Line head
 D Trimmerkopf
 RUS Головка с леской CZ Strunová hlava
 RO Cap cu cablu H Damil fej
 E Cabezal de hilo

2.4-2.7 mm M12x1.75L +4 ADAPTER 30-42 cm²



No.	Ø (mm)	
79551	2.4-2.7	10/40

PL Glowica żyłkowa
GB Line head
D Trimmerkopf
RUS Головка с леской
CZ Strunová hlava
RO Cap cu cablu
H Damil fej
E Cabezal de hilo



No.	Ø (mm)	Icon
79552	2.4-2.7	10/40

PL Żyłka tnąca
GB Grass trimmer line
D Mähfaden
RUS Леска для триммера
CZ Struna do strunové sekačky
RO Furtun gradina
H Damil szegélynyíró géphez
E Hilo de cortar



No.	Ø (mm)	L (m)	profil	Icon
89401	1.3	10	○	20/240
89402	1.6	10	○	20/240
89403	2.0	10	○	20/240
89404	2.4	10	○	12/144
89405	2.6	10	○	12/144
89406	3.0	10	○	12/144

PL Żyłka tnąca
GB Grass trimmer line
D Mähfaden
RUS Леска для триммера
CZ Struna do strunové sekačky
RO Furtun gradina
H Damil szegélynyíró géphez
E Hilo de cortar



No.	Ø (mm)	L (m)	profil	Icon
89411	1.3	10	□	20/240
89412	1.6	10	□	20/240
89413	2.0	10	□	20/240
89414	2.4	10	□	12/144
89415	2.6	10	□	12/144
89416	3.0	10	□	12/144

PL Żyłka tnąca
GB Grass trimmer line
D Mähfaden
RUS Леска для триммера
CZ Struna do strunové sekačky
RO Furtun gradina
H Damil szegélynyíró géphez
E Hilo de cortar

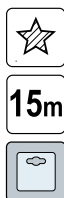

No.	Ø (mm)	L (m)	profil	Icon
89421	1.3	15	☆	24/288
89422	1.6	15	☆	20/240
89423	2.0	15	☆	16/192
89424	2.4	15	☆	12/144
89425	2.6	15	☆	12/144
89426	3.0	15	☆	10/120

PL Glowica żyłkowa
GB Line head
D Trimmerkopf
RUS Головка с леской
CZ Strunová hlava
RO Cap cu cablu
H Damil fej
E Cabezal de hilo



No.	Ø (mm)	for / dla	Icon
79468	1.2	79467	20/100

PL Żyłka tnąca
GB Grass trimmer line
D Mähfaden
RUS Леска для триммера
CZ Struna do strunové sekačky
RO Furtun gradina
H Damil szegélynyíró géphez
E Hilo de cortar



No.	Ø (mm)	L (m)	profil	Icon
89441	2.0	120	○	27
89442	2.4	90	○	27
89443	2.6	70	○	27
89444	3.0	56	○	27

PL Żyłka tnąca
GB Grass trimmer line
D Mähfaden
RUS Леска для триммера
CZ Struna do strunové sekačky
RO Furtun gradina
H Damil szegélynyíró géphez
E Hilo de cortar



No.	Ø (mm)	L (m)	profil	Icon
89452	2.4	90	□	16
89453	2.6	70	□	16
89454	3.0	56	□	16

PL Żyłka tnąca
GB Grass trimmer line
D Mähfaden
RUS Леска для триммера
CZ Struna do strunové sekačky
RO Furtun gradina
H Damil szegélynyíró géphez
E Hilo de cortar



No.	Ø (mm)	L (m)	profil	Icon
89456	2.0	90	☆	9/27
89457	2.4	90	☆	9/27
89458	2.6	90	☆	9/27
89459	3.0	60	☆	9/27

PL Żyłka tnąca
GB Grass trimmer line
D Mähfaden
RUS Леска для триммера

CZ Struna do strunové sekačky
RO Furtun gradina
H Damil szegélynyíró géphez
E Hilo de cortar



EXTRANYL

No.	Ø (mm)	L (m)	profil	
89462	2.4	15		10/120
89463	2.7	15		10/120
89464	3.0	12		10/120

PL Żyłka tnąca
GB Grass trimmer line
D Mähfaden
RUS Леска для триммера

CZ Struna do strunové sekačky
RO Furtun gradina
H Damil szegélynyíró géphez
E Hilo de cortar

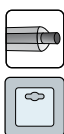

TRYGON

No.	Ø (mm)	L (m)	profil	
89470	2.4	15		10/120
89471	2.7	15		10/120
89472	3.0	12		10/120

PL Żyłka tnąca
GB Grass trimmer line
D Mähfaden
RUS Леска для триммера

CZ Struna do strunové sekačky
RO Furtun gradina
H Damil szegélynyíró géphez
E Hilo de cortar



SILENT

No.	Ø (mm)	L (m)	profil	
89478	1.6	15		20/240
89479	2.0	15		20/240
89480	2.4	15		10/120
89481	2.7	15		10/120
89482	3.0	12		10/120

PL Żyłka tnąca
GB Grass trimmer line
D Mähfaden
RUS Леска для триммера
CZ Struna do strunové sekačky
RO Furtun gradina
H Damil szegélynyíró géphez
E Hilo de cortar



EXTRANYL

No.	Ø (mm)	L (m)	profil	
89465	2.4	90		10/20
89466	2.7	70		10/20
89467	3.0	60		10/20

PL Żyłka tnąca
GB Grass trimmer line
D Mähfaden
RUS Леска для триммера
CZ Struna do strunové sekačky
RO Furtun gradina
H Damil szegélynyíró géphez
E Hilo de cortar



TRYGON

No.	Ø (mm)	L (m)	profil	
89473	2.4	90		10/20
89474	2.7	70		10/20
89475	3.0	60		10/20

PL Żyłka tnąca
GB Grass trimmer line
D Mähfaden
RUS Леска для триммера
CZ Struna do strunové sekačky
RO Furtun gradina
H Damil szegélynyíró géphez
E Hilo de cortar



SILENT

No.	Ø (mm)	L (m)	profil	
89483	2.0	90		10/20
89484	2.4	90		10/20
89485	2.7	70		10/20
89486	3.0	60		10/20

PL Przyłącze do węża do pomp zatopialnych
GB Hose connection
D Druckleitung-Anschlussstütze
RUS Соединитель для шланга
CZ Koleno k hadici
RO Ștuț de fixare furtun
H Tömítő csatlakozó
E Tubuladura para manguera para bombas de inmersiyn

G 1.5" for/dia:
79771 79775
79772 79790
79773 79781
79774 79782



No.	
79919	100

15

- PL Komplet tarcz do pilarki dwutarczowej
 GB Set of discs for double-disc sawing machines
 D Sägeblattsatz für eine Zweischeibensäge
 RUS Комплект дисков для двухдисковой пилы
 CZ Sada kotoučů pro dvoukotoučovou pilu
 RO Set de discuri pt. ferăstrău cu două discuri
 H Tárcsakészlet két tárcsás fűrészhez
 E Juego de discos para máquina de serrar de dos discos

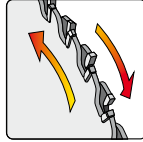
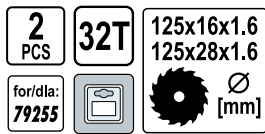

No.	Ø (mm)	for / dia	pcs	☐
79256	125x16x1.6; 125x28x1.6	79255	2	50

- PL Glowica do wiertarki samozaciskowej
 GB Drill chuck
 D Schnellspanbohrfutter
 RUS Патрон для дрели быстрозажимной
- CZ Hlava na vrtáčku samosvorná
 RO Mandrină cu autostrângere pt. bormașină
 H Az önbeszorulás fűrőgéptokmányfej
 E Cabeza para taladradora autoapriete

2-13 mm

1/2" (12.5 mm) - 20 UNF



No.	Ø (mm)	size / rozmiar	☐
79580	2-13	1/2" (12.5 mm)	5/40

- PL Adapter SDS-plus - UNF 1/2"
 GB Adapter SDS-plus - UNF 1/2"
 D Adapter SDS-plus - UNF 1/2"
 RUS Переходник с SDS плюс на 1/2 дюйма
 CZ Přenoska SDS-plus - UNF 1/2"
 RO Adaptor SDS-plus - UNF 1/2"
 H SDS-plus adapter - UNF 1/2"
 E Adaptor SDS-plus - UNF 1/2"

1/2" (12.5 mm) - 20 UNF

SDS PLUS



No.	size / rozmiar	☐
79800	1/2" (12.5 mm)	12/144

- PL Wielofunkcyjna ostrzałka do wiertel
 GB Multipurpose drill bit sharpener
 D Vielzweck Bohrer schleifgerät
 RUS Машина для заточки свёрл
- CZ Ostrůvka pro ostření vrtáků
 RO Masina de ascuțit burghie
 H Fűrőélező
 E Afiladora de brocas



TWO ABRASIVE DISCS
 DWIE TARCZE ŚCIERNE



No.	w	☐
73470	70	6

- PL Glowica do wiertarki samozaciskowej
 GB Drill chuck
 D Schnellspanbohrfutter
 RUS Патрон для дрели быстрозажимной
- CZ Hlava na vrtáčku samosvorná
 RO Mandrină cu autostrângere pt. bormașină
 H Az önbeszorulás fűrőgéptokmányfej
 E Cabeza para taladradora autoapriete



No.	Ø (mm)	size / rozmiar	☐
79570	1-10	3/8" (10.0 mm)	10/50
79572	1-10	1/2" (12.5 mm)	10/50

- PL Glowica do wiertarki na klucz
 GB Drill chuck
 D Schnellspanbohrfutter
 RUS Патрон для дрели зубчатый
- CZ Hlava na vrtáčku na klíč
 RO Mandrină cu cheie pt. bormașină
 H Az önbeszorulás fűrőgéptokmányfej
 E Cabeza para taladradora de llave



No.	Ø (mm)	size / rozmiar	☐
79600	1.5-10	3/8" (10.0 mm)	10/50
79620	1.5-10	1/2" (12.5 mm)	10/50
79630	1.5-13	1/2" (12.5 mm)	5/40

- PL Ostrzarka do wiertarki
 GB Rotary sharpener
 D Bohrer scharfer-Bohrmaschinenaufsatz
 RUS Точило для ножей и ножиц
- CZ Brousek na nože a nůžky
 RO Rezerva pt dispozitiv de ascuțit burghie
 H Élezőkö fűrőgéphe fogható
 E Muela afilar cuchillos y tijeras

4500 min⁻¹ (max)



No.	☐
26225	80/240

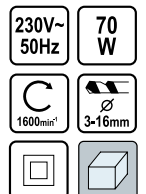

L_{pa} = 61,0 ± 3,0 dB; L_{wa} = 74,0 ± 3,0 dB

- PL Ostrzałka wielofunkcyjna
 GB Multi-function sharpener
 D Multifunktionales Schärfergerät
 RUS Многофункциональный заточной станок
 CZ Víceúčelová bruska
 RO Mașină de ascuțit multifuncțională
 H Multifunkciós élezőgép
 E Afilador multifuncional

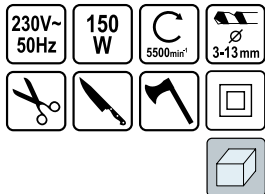

STHOR

$L_{pA} = 81,56 \pm 3,0$ dB; $L_{wA} = 94,56 \pm 3,0$ dB

No.	W	
73473	150	2

- PL Stojak do wiertarki
 GB Drill stand
 D Bohrmaschinenständer
 RUS Сверлильная станция
 CZ Stativ do vrtačky
 RO Suport masina de gaurit
 H Fúróállvány
 E Soporte para taladro

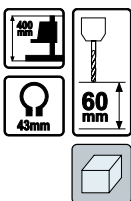

VOREL

No.	h (mm)	
79640	400	10

- PL Tarniki trzpieniowe
 GB Rotary file set
 D Raspelaufsatz
 RUS Набор металлических бор-фрез
- CZ Hrotové rašple
 RO Set raspile cu tija
 H Fareszelőkészlet, csapszárás
 E Escofinas



No.	Ø (mm)	pcs	
25400	6	5	25/200

- PL Statyw do szlifierek kątowych
 GB Angle grinder stand
 D Winkelschleif-Trennständer
 RUS Штатив
- CZ Stojan pro úhlovou brusku
 RO Stativ pt. polizor unghiular
 H Állvány sarokcsiszolóhoz
 E Soporte para lijadora de ángulo



VOREL

No.	
79641	4

- PL Zapasowe ostrza do struga elektrycznego
 GB Spare cutting knife for electric planner
 D Hobelmesser für Elektrohobel
 RUS Лезвия для электрорубанка
 CZ Náhradní nůž pro elektr. hoblíku
 RO Lamă de rezervă pt. rindea electrică
 H Tartalék gyalukés elektromos gyalugéphez
 E Filos de repuesto para cepillo eléctrico



STHOR

No.	pcs/packing	
79346	2	30/360

- PL Kamienie szlifierskie trzpieniowe
 GB Mounted stone set
 D Schleifsteinaufsätze
 RUS Набор абразивных наконечников
- CZ Brusné kameny hrotové
 RO Set pietre abrazive cu tija
 H Csiszolókő készlet, csapszárú
 E Discos de esmeril

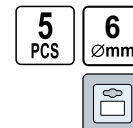

No.	Ø (mm)	pcs	
25400	6	5	25/200

- PL Zestaw końcówek do szlifiarki
 GB Mini grinder accessories set
 D Schleifaufsätze
 RUS Набор шлифовальных и полировочных насадок для арт. 79316
- CZ Soustava koncovek na brusku
 RO Set pietre abrazive si pasla pt. slefuit
 H Fejkészlet csiszológéphez
 E Juego de puntas de pulir



VOREL

No.	pcs	
25410	13	10/50

- PL Zestaw końcówek do szlifierki
 GB Mini grinder accessories set
 D Schleifaufsätze
 RUS Набор шлифовальных и полировочных насадок для арт. 79316
- CZ Soustava koncovek na brusku
 RO Set pietre abrazive si pasla pt. slefuit
 H Fejkészlet csiszológéphez
 E Juego de puntas de pulir

17
PCS





No.	pcs	box
25411	17	10/50

- PL Nakładki polerujące
 GB Polishing covers
 D Polierscheibe
 RUS Полировочные накладки
- CZ Leštičí kotouč
 RO Polizor captusit
 H Polírozó korong
 E Fundas

2
PCS

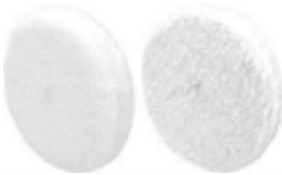
Ø [mm]
245

No.	Ø (mm)	for / dia	pcs packing	box
82941	245	82940	2	10/100

- PL Wkłady klejowe
 GB Glue sticks
 D Heissklebpatronen
 RUS Тубы для клеящего пистолета
- CZ Lepicí vložky
 RO Articole plastic (pt. pistol lipit)
 H Ragasztóbetét
 E Cartucho de cola

WORKING TEMPERATURE
TEMPERATURA PRACY
170-200°C

SOFTENING POINT
TEMPERATURA MIEKNIENIA
85+/-2°C

TRANSPARENT
BEZBARWNE

UNIVERSAL
UNIVERSALNE



application: cardboard, wood, plastic, leather, fabrics
 zastosowanie: tektura, drewno, plastik, skóra, tkaniny

No.	mm	pcs	box
73260	7x100	12	50/200
73270	11x100	6	20/120
73271	11x150	12	20/60

- PL Stojak do lutownicy
 GB Soldering iron stand
 D LötKolbenständer
 RUS Подставка для паяльника
- CZ Stojan na pájku
 RO Suport pt. ciocan lipit
 H Forrasztópáka tartó
 E Caballete de soldador



No.	box
79386	50/100

- PL Zestaw końcówek do szlifierki
 GB Mini grinder accessories set
 D Schleifaufsätze
 RUS Набор шлифовальных и полировочных насадок для арт. 79316
- CZ Soustava koncovek na brusku
 RO Set pietre abrazive si pasla pt. slefuit
 H Fejkészlet csiszológéphez
 E Juego de puntas de pulir

22
PCS



No.	pcs packing	box
25412	22	10/50

- PL Wkłady klejowe
 GB Glue sticks
 D Heissklebpatronen
 RUS Тубы для клеящего пистолета
- CZ Lepicí vložky
 RO Articole plastic (pt. pistol lipit)
 H Ragasztóbetét
 E Cartucho de cola

WORKING TEMPERATURE
TEMPERATURA PRACY
170-200°C

SOFTENING POINT
TEMPERATURA MIEKNIENIA
85+/-2°C

TRANSPARENT
BEZBARWNE

UNIVERSAL
UNIVERSALNE



application: cardboard, wood, plastic, leather, fabrics
 zastosowanie: tektura, drewno, plastik, skóra, tkaniny

No.	mm	kg	box
73300	11x200	1	10

- PL Zestaw „trzecia ręka”
 GB Helping hand with magnifying glass
 D Hilffhand mit Lupe
 RUS Комплект „третья рука” с лупой
 CZ Sada „třetí ruka”
 RO Ceva cu lupa
 H Paneltartó állvány „harmadik kéz”
 E Juego „la tercera mano” con lupa



No.	glass / szkło Ø (mm)	box
73500	62	10/40

- PL Spoiwo lutownicze
 GB Solder
 D Lötzinn
 RUS Припой
- CZ Pájka
 RO Sarna de sudura
 H Forrasztó ón
 E Estaño plata

Sn60
Pb40



>>>

No.	Ø (mm)	weight / waga (g)	box
76800	0.5	100	30
76801	0.5	250	20
76806	0.7	100	30
76807	0.7	250	20
76810	1.0	100	30

PL Spoiwo lutownicze
GB Solder
D Lötzinn
RUS Припой

CZ Pájka
RO Sarna de sudura
H Forrasztó ón
E Estaño plata

Sn60
Pb40



No.	Ø (mm)	weight / waga (g)	
76811	1.0	250	20
76814	1.5	100	30
76815	1.5	250	20
76818	2.0	100	30
76819	2.0	250	20
76822	2.5	100	30
76823	2.5	250	20
76826	3.0	100	30
76827	3.0	250	20

PL Pasta lutownicza
GB Solder paste
D Lotpaste
RUS Паяльная паста

CZ Pájecí pasty
RO Pasta decapante sudura
H Forrasztó paszta
E Pasta de soldar

FLUX
TOPNIK
112 G
PN EN 28454



No.	weight / waga (g)	
76835	40	50

PL Kalafonia lutownicza
GB Rosin
D Kolophonium
RUS Канифоль

CZ Kalafuna
RO Colofoniu
H Forrasztó gyanta
E Colofonia



No.	weight / waga (g)	
76836	45	50

PL Zestaw narzędzi lutowniczych
GB Soldering accessories
D Lötzubehör
RUS Принадлежности для пайки

CZ Pájecí příslušenství
RO Accesorii de lipit
H Forrasztó tartozékok
E Jooteseadmed tarvikud

6
PCS

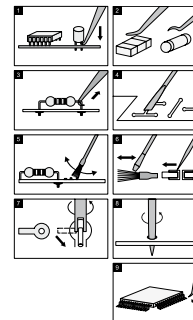

No.	pcs	
79398	6	25/100

PL Spoiwo lutownicze
GB Solder
D Lötzinn
RUS Припой

CZ Pájka
RO Sarna de sudura
H Forrasztó ón
E Estaño plata

Sn60
Pb40



No.	Ø (mm)	weight / waga (g)	
76830	1.0	16	25/500

PL Cyna w lasce
GB Solder stick
D Stangenlötzinn
RUS Припой

CZ Pájka v tyčkách
RO Baghete de sudura
H Forrasztó rúd
E Barra estaño plomo

Sn60
Pb40



No.	dimensions / wymiary (mm)	weight / waga (kg)	
76832	7x7x322	5	1

PL Odsysacz do cyny
GB Desoldering pump
D Entlötsaugpumpe
RUS Шприц для удаления припоя

CZ Odpájecí sací pumpa
RO Pompa fluidor
H Ónszipantó
E Bomba desoldadora

PTFE
TIP



No.	
79390	100/400

PL Odsysacz do cyny
GB Desoldering pump
D Entlötlötpumpe
RUS Шприц для удаления припоя

CZ Odpájecí sací pumpa
RO Pompa fluidor
H Ónszippantó
E Bomba desoldadora



No.	
79391	70/140

PL Wąż tłoczny do motopomp z końcówkami
GB Pumping hose for motor pumps with terminals
D Druckschlauch für Motorpumpen mit Anschlussstücken
RUS Напорный рукав для мотопомп с наконечниками
CZ Výtlačná hadice s koncovkami pro motorová čerpadla
RO Furtun pt. motopompe cu capete
H Szivattyú nyomótömlő csatlékkal szerelve
E Manguera para bombear para motobombas con terminales



No.	L (m)	Ø	max. working pressure / max. ciśnienie robocze (bar)	bursting pressure / ciśnienie rozrywające (bar)	
79977	20	2" (50 mm)	6	24	1
79978	20	3" (75 mm)	6	24	1
79979	20	4" (100 mm)	6	24	1

PL Nasada Storza z gwintem wewnętrznym
GB Storz attachment with internal thread
D Aufsatzarmatur mit Innengewinde wg Storz
RUS Гайка Шторца с внутренней резьбой

CZ Adaptér Storz s vnitřním závitem
RO Racord Storz cu filet interior
H Csonkkapocs belső menetes
E Boquilla Storz con rosca interna



No.	Ø	bursting pressure / ciśnienie rozrywające (bar)	
79990	2" (50 mm)	48	1
79991	3" (75 mm)	48	1
79992	4" (100 mm)	48	1

PL Wąż ssący z końcówkami
GB Suction hose with terminals
D Saugschlauch mit Anschlussstücken
RUS Шланг всасывающий с наконечниками

CZ Sací hadice s koncovkami
RO Furtun sucțiune cu capete
H Szivattyú szívótömlő csatlékkal szerelve
E Manguera de succión con terminales



No.	L (m)	Ø	
80001	2.5	3" (75 mm)	1
80002	2.5	4" (100 mm)	1

PL Opaska antystatyczna
GB Antistatic wrist strap
D Antistatisches Armband
RUS Браслет антистатический

CZ Pásek antiostatický
RO Cureau antiostatice
H Antisztatikus csuklópánt
E Pulsera antiestatice



No.	
79395	100

PL Wąż tłoczny do motopomp
GB Pumping hose for motor pumps
D Druckschlauch für Motorpumpen
RUS Напорный рукав для мотопомп

CZ Výtlačná hadice pro motorová čerpadla
RO Furtun pt. motopompe
H Szivattyú nyomótömlő
E Manguera para bombear para motobombas



No.	L (m)	Ø	max. working pressure / max. ciśnienie robocze (bar)	bursting pressure / ciśnienie rozrywające (bar)	
79982	50	1" (25 mm)	2	6	1
79983	50	2" (50 mm)	2	6	1
79984	50	3" (75 mm)	2	6	1

PL Łączniki Storza tłoczne
GB Pumping Storz connectors
D Druckverbinderarmatur wg Storz
RUS Гайки Шторца напорные

CZ Spojka Storz výtlačná
RO Racorduri Storz descărcare
H Tömlőkapcsok, nyomó
E Conectores Storz para bombeo



No.	Ø	bursting pressure / ciśnienie rozrywające (bar)	
79993	2" (50 mm)	48	1
79994	3" (75 mm)	48	2

PL Łączniki Storza ssawne
GB Suction Storz connectors
D Saugverbinderarmatur wg Storz
RUS Гайки Шторца всасывающие

CZ Spojka Storz sací
RO Racorduri Storz sucțiune
H Tömlőkapcsok, szívó
E Conectores Storz para succión



No.	Ø	bursting pressure / ciśnienie rozrywające (bar)	
79996	2" (50 mm)	48	1
79997	3" (75 mm)	48	1
79998	4" (100 mm)	48	2

16

Welding equipment
Sprzęt spawalniczy



Welding machines
Spawarki

248

Welding accessories
Akcesoria spawalnicze

248-254

Electrodes & welding wires

Elektrody i druty do spawania..... 248

Clamps

Zaciski spawalnicze..... 249

Welding goggles & masks

Okulary i maski spawalnicze..... 249

Hammers

Młotki..... 252

Lock grip pliers

Szczypce zaciskowe..... 252

Tin snips

Nożyce do blachy..... 253

PL Spawarka inwerterowa
 GB Inverter welder
 D Inverter-Schweißanlage
 RUS Инверторный сварочный аппарат
 CZ Svářečka inverterová
 RO Invertor sudura
 H Hegesztő trafó
 E Soldadora de inversión

230V~ 50Hz	IGBT	MMA	HOT START GORĄCY START	ANTI STICK FUNKCJA PRZECIWN ZWARCZOWA	ARC FORCE STABILIZACJA ŁUKU
140 A	DUTY CYCLE CYKL PRACY 20%	ELECTRODE SIZE ROZMIAR ELEKTRODY 1.0~4.0 mm	PROTECTION GRADE STOPNIEN OCHRONY IP21S	WINDING INSULATION CLASS KLASA IZOLACJI UZWIĘZIENIA F	POWER GENERATOR SUPPLY MOŻLIWOŚĆ ZASILANIA Z GENERATORA



No.	A	
73205	140	1

PL Spawarka inwerterowa
 GB Inverter welder
 D Inverter-Schweißanlage
 RUS Инверторный сварочный аппарат
 CZ Svářečka inverterová
 RO Invertor sudura
 H Hegesztő trafó
 E Soldadora de inversión

230V~ 50Hz	IGBT	MMA	HOT START GORĄCY START	ANTI STICK FUNKCJA PRZECIWN ZWARCZOWA	ARC FORCE STABILIZACJA ŁUKU
180 A	DUTY CYCLE CYKL PRACY 15%	ELECTRODE SIZE ROZMIAR ELEKTRODY 1.0~5.0 mm	PROTECTION GRADE STOPNIEN OCHRONY IP21S	WINDING INSULATION CLASS KLASA IZOLACJI UZWIĘZIENIA F	POWER GENERATOR SUPPLY MOŻLIWOŚĆ ZASILANIA Z GENERATORA



No.	A	
73207	180	1

PL Elektrody rutyłowe
 GB Welding electrodes
 D Rutilstabelektroden
 RUS Сварочный электрод

CZ Elektrody
 RO Electrozi pt. sudura
 H Elektrodák
 E Elektrods



No.	Ø (mm)	L (mm)	kg	
74307	2.5	350	4	1
74311	3.2	450	5	1
74316	4.0	450	6	1

PL Spawarka inwerterowa
 GB Inverter welder
 D Inverter-Schweißanlage
 RUS Инверторный сварочный аппарат
 CZ Svářečka inverterová
 RO Invertor sudura
 H Hegesztő trafó
 E Soldadora de inversión

230V~ 50Hz	IGBT	MMA	HOT START GORĄCY START	ANTI STICK FUNKCJA PRZECIWN ZWARCZOWA	ARC FORCE STABILIZACJA ŁUKU
160 A	DUTY CYCLE CYKL PRACY 20%	ELECTRODE SIZE ROZMIAR ELEKTRODY 1.0~4.0 mm	PROTECTION GRADE STOPNIEN OCHRONY IP21S	WINDING INSULATION CLASS KLASA IZOLACJI UZWIĘZIENIA F	POWER GENERATOR SUPPLY MOŻLIWOŚĆ Z GENERATORA



No.	A	
73206	160	1

PL Spawarka inwerterowa
 GB Inverter welder
 D Inverter-Schweißanlage
 RUS Инверторный сварочный аппарат
 CZ Svářečka inverterová
 RO Invertor sudura
 H Hegesztő trafó
 E Soldadora de inversión

230V~ 50Hz	IGBT	MMA	HOT START GORĄCY START	ANTI STICK FUNKCJA PRZECIWN ZWARCZOWA	ARC FORCE STABILIZACJA ŁUKU
200 A	DUTY CYCLE CYKL PRACY 10%	ELECTRODE SIZE ROZMIAR ELEKTRODY 1.0~6.0 mm	PROTECTION GRADE STOPNIEN OCHRONY IP21S	WINDING INSULATION CLASS KLASA IZOLACJI UZWIĘZIENIA F	POWER GENERATOR SUPPLY MOŻLIWOŚĆ ZASILANIA Z GENERATORA



No.	A	
73208	200	1

PL Drut spawalniczy
 GB Welding wire
 D Fühldraht
 RUS Сварочная проволока
 стальная

CZ Drát svařovací
 RO Sarna pt. sudura
 H Forrasztó öm
 E Alambre de soldado

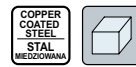

No.	Ø (mm)	kg	
74255	0.8	5	1

PL Zacisk spawalniczy
biegunowo-kleszczowy
GB Clamp
D Schweisseklemme
RUS Клещи для сварки

CZ Kleště svářečské zemnici
RO Cleste pt. sudura
H Testkábel-csatlakozó
E Coccodrilo para soldar



No.	max welding current / max prąd spawania (A)	Ø earthing cable / Ø kabla masowego (mm ²)	max range / max rozwarcie (mm)	weight / waga (kg)	type	
74420	160	35	50	0.21	ZBK-35	25
74421	315	70	60	0.25	ZBK-70	25
74422	520	95	70	0.29	ZBK-95	25

PL Okulary spawalnicze
GB Welding goggles
D Schweisserbrille
RUS Очки газосварщика

CZ Brýle svářečské
RO Ochelari pt. sudura
H Hegesztőszemüveg
E Gafas para soldar

TITLED FRAME UCHYLNA OPRAWA
ADJUSTABLE REGULOWANY
IMPACT RESISTANT ODPORNY NA UDERZENIA
FILTER FILTR DIN 5
FILTER FILTR Ø50mm
PROTECTION LENS SZYBKĄ OCHRONĄ Ø50mm
WITH VENTILATION Z WENTYLACJĄ
FOR GAS WELDING DO SPAWANIA GAZOWEGO
FOR GRINDING DO SZLIFOWANIA



No.	
74400	25/100

PL Okulary spawalnicze
GB Welding goggles
D Schweisserbrille
RUS Очки газосварщика

CZ Brýle svářečské
RO Ochelari pt. sudura
H Hegesztőszemüveg
E Gafas para soldar

TITLED FRAME UCHYLNA OPRAWA
ADJUSTABLE REGULOWANY
IMPACT RESISTANT ODPORNY NA UDERZENIA
FILTER FILTR DIN 5
FILTER FILTR Ø50mm
PROTECTION LENS SZYBKĄ OCHRONĄ Ø50mm
FOR GAS WELDING DO SPAWANIA GAZOWEGO
FOR GRINDING DO SZLIFOWANIA



No.	
74411	10/100

PL Uchwyt spawalniczy elektrodowy
GB Electrode holder
D Schweisselektrodengriff
RUS Клещи для сварки (электродные)

CZ Držák elektrod
RO Cleste pt. sudura cu electrod
H Elektrodafogó
E Abrazadera para soldar, de electrodos



No.	max welding current / max prąd spawania (A)	electrode diameter / średnica elektrod (mm)	Ø welding cable / Ø przewodu spawalniczego (mm ²)	weight / waga (kg)	type	
74430	200A (X=60%) / 315A (X=35%)	35-50	2-5	0.32	UE-200	25
74431	315A (X=60%) / 400A (X=35%)	50-70	2.5-6.3	0.42	UE-300	25
74432	430A (X=60%) / 530A (X=35%)	70-95	3.5-6.3	0.50	UE-400	25

PL Okulary spawalnicze
GB Welding goggles
D Schweisserbrille
RUS Очки газосварщика

CZ Brýle svářečské
RO Ochelari pt. sudura
H Hegesztőszemüveg
E Gafas para soldar

TITLED FRAME UCHYLNA OPRAWA
ADJUSTABLE REGULOWANY
IMPACT RESISTANT ODPORNY NA UDERZENIA
FILTER FILTR DIN 5
FILTER FILTR Ø50mm
PROTECTION LENS SZYBKĄ OCHRONĄ Ø50mm
FOR GAS WELDING DO SPAWANIA GAZOWEGO
FOR GRINDING DO SZLIFOWANIA



No.	
74410	5/100

PL Maska spawalnicza
GB Welding mask
D Schweissermaske
RUS Щиток сварщика
CZ Svářečská maska
RO Mască de sudură
H Hegesztőpajzs
E Mascara de soldador

FILTER SIZE ROZMIAR FILTRA 50x100 (mm)
237x359 x78 mm
FILTER FILTR DIN 8
WEIGHT WITHOUT LENS WAGA BEZ SZKIEL 268 g



No.	type	
74440	TSM-3	30

PL Maska spawalnicza
GB Welding mask
D Schweissermaske
RUS Щиток сварщика
CZ Svářečská maska
RO Mască de sudură
H Hegesztőpajzs
E Mascara de soldador

FILTER SIZE ROZMIAR FILTRA 50x100 mm
222x372 x80 mm
FILTER FILTR DIN 10
WEIGHT WITHOUT LENS WAGA BEZ SZKIEŁ 366 g



No.	type	
74442	TSM	30

PL Maska spawalnicza
GB Welding mask
D Schweissermaske
RUS Щиток сварщика
CZ Svářečská maska
RO Mască de sudură
H Hegesztőpajzs
E Mascara de soldador

FILTER SIZE ROZMIAR FILTRA 50x100 mm
257x450 x96 mm
WEIGHT WITHOUT LENS WAGA BEZ SZKIEŁ 455 g



No.	type	
74450	TSD-3	20

PL Przyłbica spawalnicza z podglądem
GB Welding mask
D Schweissermaske
RUS Щиток сварщика с подсмотром
CZ Svářečská přilba s nakoukáváním
RO Mască de sudură cu geam
H Hegesztősisak kitékintővel
E Mascara de soldador con mirador

FILTER SIZE ROZMIAR FILTRA 50x100 mm DIN 8-13
SPECTACLE LENS SIZE SZKIEŁA BEZ WYKŁADZIEK 20x100 mm (DIN 5)
225x290 x175 mm
FILTER FILTR DIN 10
WEIGHT WITHOUT LENS WAGA BEZ SZKIEŁ 427 g



No.	type	
74448	PS-3	10

PL Maska spawalnicza
GB Welding mask
D Schweissermaske
RUS Щиток сварщика
CZ Svářečská maska
RO Mască de sudură
H Hegesztőpajzs
E Mascara de soldador

FILTER SIZE ROZMIAR FILTRA 50x100 mm
SPECTACLE LENS SIZE SZKIEŁA BEZ WYKŁADZIEK 20x100 mm (DIN 5)
222x372 x80 mm
FILTER FILTR DIN 10
WEIGHT WITHOUT LENS WAGA BEZ SZKIEŁ 408 g



No.	type	
74443	TSM	20

PL Przyłbica spawalnicza z podglądem
GB Welding mask
D Schweissermaske
RUS Щиток сварщика с подсмотром
CZ Svářečská přilba s nakoukáváním
RO Mască de sudură cu geam
H Hegesztősisak kitékintővel
E Mascara de soldador con mirador

FILTER SIZE ROZMIAR FILTRA 50x100 mm DIN 8-13
SPECTACLE LENS SIZE SZKIEŁA BEZ WYKŁADZIEK 20x100 mm (DIN 5)
195x265 x170 mm
FILTER FILTR DIN 10
WEIGHT WITHOUT LENS WAGA BEZ SZKIEŁ 332 g



No.	type	
74447	PSMP	20

PL Maska spawalnicza
GB Welding mask
D Schweissermaske
RUS Щиток сварщика
CZ Svářečská maska
RO Mască de sudură
H Hegesztőpajzs
E Mascara de soldador

110x90 mm
FILTER FILTR DIN 12



No.	type	
74441		20



- PL Przyłbica spawalnicza
 GB Welding mask
 D Schweissmaske
 RUS Щиток сварщика
- CZ Svářečská přilba s nakoukáváním
 RO Mască de sudură cu geam
 H Hegesztősisak kitekintővel
 E Mascara de soldador con mirador



No.	4
74457	20

- PL Przyłbica spawalnicza samościemniająca
 GB Auto-darkening welding helmet
 D Schweissmaske, selbstverdunkelnd
 RUS Маска для сварки, самостоятельно затемняющаяся
 CZ Svářečská kukla samostmívací
 RO Mască de sudură auto-întunecare
 H Őnmagától sötétedő hegesztőpajzs
 E Casco auto-oscurecedor para soldadura



No.	6
74480	6

- PL Oslona filtra
 GB Filter shield
 D Filterabdeckung
 RUS Кожух фильтра
- CZ Ochrana filtru
 RO Aparătoare de filtru
 H Szűrőfedél
 E Protección de filtro

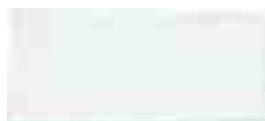

No.	mm	type / typ	4
74451	50x100	DIN 0	150

- PL Przyłbica spawalnicza samościemniająca
 GB Auto-darkening welding helmet
 D Schweissmaske, selbstverdunkelnd
 RUS Маска для сварки, самостоятельно затемняющаяся
 CZ Svářečská kukla samostmívací
 RO Mască de sudură auto-întunecare
 H Őnmagától sötétedő hegesztőpajzs
 E Casco auto-oscurecedor para soldadura

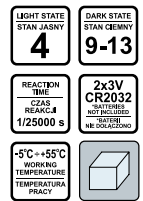

No.	6
74435	6

- PL Przyłbica spawalnicza
 GB Welding helmet
 D Schweissmaske
 RUS Щиток сварщика
 CZ Svářečská maska
 RO Mască de sudură
 H Hegesztőpajzs
 E Mascara de soldador



No.	12
74449	12

- PL Filtr spawalniczy
 GB Welding filter
 D Vorsatzglas
 RUS Фильтр для сварки
- CZ Filtr svářečský
 RO Filtru pt. sudări
 H Hegesztőszűrő
 E Pantalla de filtro de soldador



No.	mm	type / typ	4
74452	50x100	DIN 8	100
74453	50x100	DIN 9	100
74454	50x100	DIN 10	100
74455	50x100	DIN 11	100
74456	50x100	DIN 12	100

- PL Osłona filtra przybicia samościemniającej
 GB Self-dimming helmet filter protection
 D Filtereinsatz eines selbstabdunkelnden Schutzhelmes
 RUS Кожух фильтра самозатемняющегося щитка
 CZ Ochranná fólie filtru samostmivací kukly
 RO Carcasă filtru vizieră heliomată
 H Hegesztőpajzs szűrő, önsötétedő
 E Protección del filtro de visera autooscurecedora



No.	mm	pcs	
74439	90x110	5	20

- PL Młotek drewniany blacharski
 GB Wooden mallet
 D Holzhammer für Bleche
 RUS Молоток жестящика, деревянный
- CZ Palice dřevěná klempířská
 RO Ciocan din lemn de tinichigiu
 H Bádogos fakalapács
 E Martillo de madera de hojalatero



No.	mm	
33532	285	20

- PL Szczypce spawalnicze
 GB Lock grip pliers
 D Schweisserzange
 RUS Ключ - зажим
- CZ Svářečské kleště
 RO Cleste autoblocant pt. sudura
 H Hegesztő fogó
 E Alicates de soldar



No.	L (mm)	type	
44300	275	C	6/36

- PL Szczypce spawalnicze
 GB Lock grip pliers
 D Schweisserzange
 RUS Ключ - зажим
- CZ Svářečské kleště
 RO Cleste autoblocant pt. sudura
 H Hegesztő fogó
 E Alicates de soldar



No.	L (mm)	type	
44400	225	W	6/36

- PL Młotek blacharski, guma - plastik
 GB Soft faced mallet
 D Ausbeulhammer
 RUS Молоток рихтовочный
- CZ Klempířské kladívko
 RO Ciocan pt. tabla
 H Bádogos kalapács
 E Mazo goma-plastico



No.	mm	
33950	35	30/60

- PL Młotek spawalniczy
 GB Welder's hammer
 D Schweisserhammer
 RUS Молоток сварочный
- CZ Svářečské kladívko
 RO Ciocan de sudură
 H Hegesztő kalapács
 E Martillo para soldar



No.	g	
32110	350	5

- PL Szczypce zaciskowe klamrowe typu „C”
 GB Welding locking pliers „C” type
 D Klemm- und Klammerzange vom Typ „C”
 RUS Клещи давяльные типа „C”
 CZ Kleště samosvorné upínací typu „C”
 RO Clește de strângere cu clemă tip „C”
 H „C” fogó
 E Pinzas de tornillo (de apriete) de grapa tipo „C”



No.	L (mm)	type	
44301	280	C	6/30

- PL Szczypce spawalnicze
 GB Lock grip pliers
 D Schweisserzange
 RUS Ключ - зажим
- CZ Svářečské kleště
 RO Cleste autoblocant pt. sudura
 H Hegesztő fogó
 E Alicates de soldar



No.	L (mm)	type	
44500	250	SM	6/36

PL Nożyce do blachy
GB Figure tin snips
D Blechscher
RUS Ножницы по металлу

CZ Nůžky na plech
RO Foarfece pt. tablă
H Lemezvágó olló
E Tijeras para hojalata



No.	L (mm)	max (mm)	
48000	250	1.5	6/36

PL Nożyce do blachy
GB Figure tin snips
D Blechscher
RUS Ножницы по металлу

CZ Nůžky na plech
RO Foarfece pt. tablă
H Lemezvágó olló
E Tijeras para hojalata



No.	L (mm)	max (mm)	
48080	250	1.0	6/36

PL Nożyce do blachy
GB Figure tin snips
D Blechscher
RUS Ножницы по металлу

CZ Nůžky na plech
RO Foarfece pt. tablă
H Lemezvágó olló
E Tijeras para hojalata

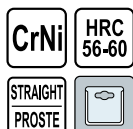

No.	L (mm)	max (mm)	
48082	250	1.0	6/36

PL Nożyce do blachy
GB Figure tin snips
D Blechscher
RUS Ножницы по металлу

CZ Nůžky na plech
RO Foarfece pt. tablă
H Lemezvágó olló
E Tijeras para hojalata



No.	L (mm)	max (mm)	
48050	250	1.5	6/36

PL Nożyce do blachy
GB Figure tin snips
D Blechscher
RUS Ножницы по металлу

CZ Nůžky na plech
RO Foarfece pt. tablă
H Lemezvágó olló
E Tijeras para hojalata

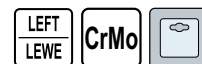

No.	L (mm)	max (mm)	
48060	250	1.2	6/48

PL Nożyce do blachy
GB Figure tin snips
D Blechscher
RUS Ножницы по металлу

CZ Nůžky na plech
RO Foarfece pt. tablă
H Lemezvágó olló
E Tijeras para hojalata



No.	L (mm)	
48100	250	6/60

PL Nożyce do blachy
GB Figure tin snips
D Blechscher
RUS Ножницы по металлу

CZ Nůžky na plech
RO Foarfece pt. tablă
H Lemezvágó olló
E Tijeras para hojalata



No.	L (mm)	
48200	250	6/48

PL Nożyce do blachy
GB Figure tin snips
D Blechscher
RUS Ножницы по металлу

CZ Nůžky na plech
RO Foarfece pt. tablă
H Lemezvágó olló
E Tijeras para hojalata



No.	L (mm)	max (mm)	
48070	250	1.2	6/48

PL Nożyce do blachy
GB Figure tin snips
D Blechscher
RUS Ножницы по металлу

CZ Nůžky na plech
RO Foarfece pt. tablă
H Lemezvágó olló
E Tijeras para hojalata



No.	L (mm)	max (mm)	
48081	250	1.0	6/36

PL Nożyce do blachy
GB Figure tin snips
D Blechscher
RUS Ножницы по металлу

CZ Nůžky na plech
RO Foarfece pt. tablă
H Lemezvágó olló
E Tijeras para hojalata

No.	L (mm)	pcs	
48330	250	3	5/20

PL Nożyce do blachy
GB Figure tin snips
D Blechscher
RUS Ножницы по металлу

CZ Nůžky na plech
RO Foarfece pt. tablă
H Lemezvágó olló
E Tijeras para hojalata



No.	L (mm)	
48150	250	6/60



Memo

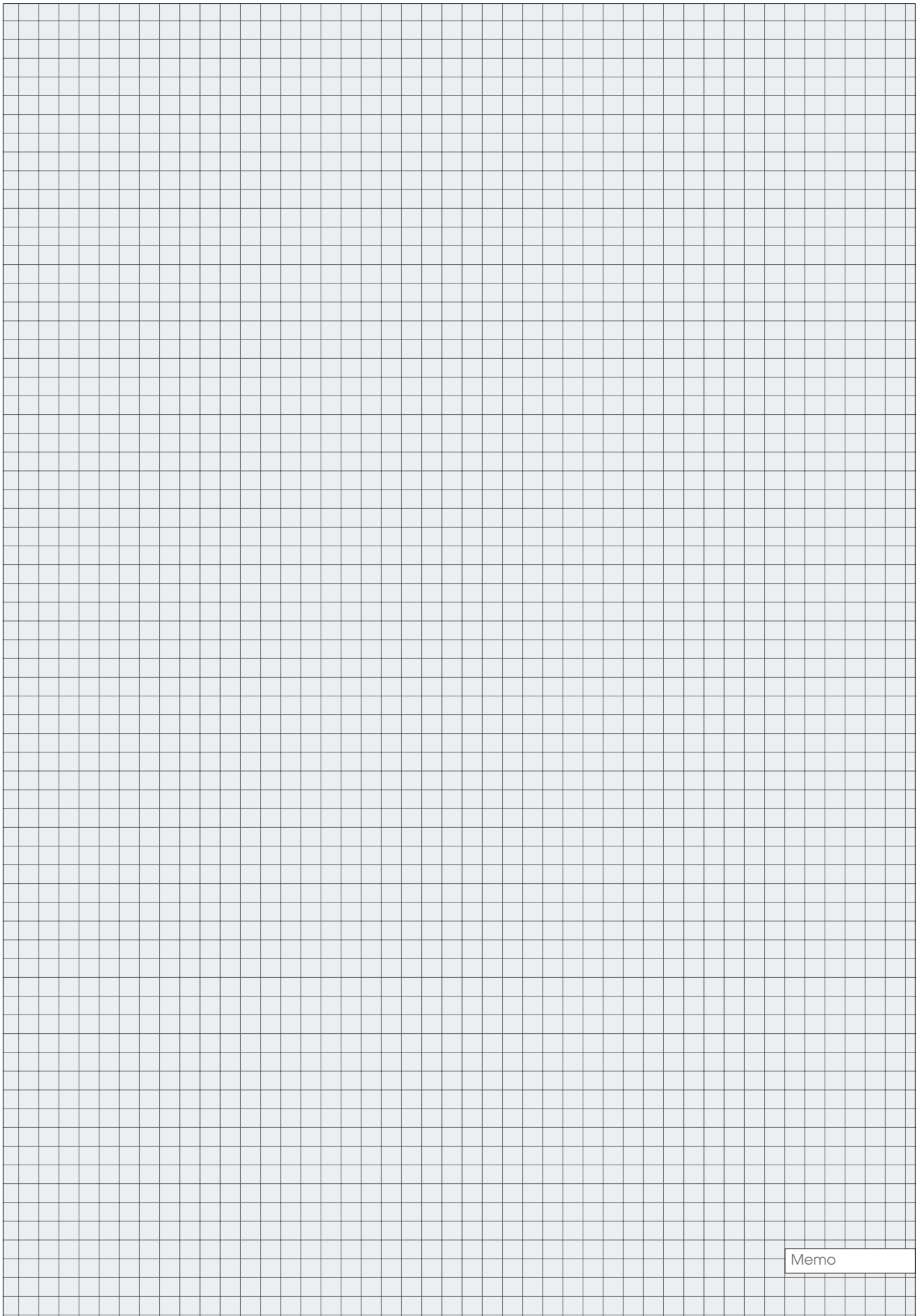

Memo

17

Safes, padlocks & locks
Sejfy, klódki i zamki



Safes
Sejfy

.....258

**Key boxes**
Skrzynki na klucze

.....258

**Cash boxes**
Kasetki na pieniądze

.....258-259

**Padlocks**
Kłódki

.....259-261

**Cast iron padlocks**

Kłódki żeliwne..... 259

Brass padlocks

Kłódki mosiężne..... 260

Lock cylinders & bodies
Wkładki do zamków i zamki

.....261-265

**Brass lock cylinders**

Wkładki mosiężne..... 261

Door locks

Zamki do drzwi..... 262

Safety chains

Łańcuchy do drzwi..... 264

Door closers

Samozamykacze..... 264

Door peep holes

Wizjery..... 264

Bicycle & motorcycle locks
Zamknięcia do rowerów i motocykli

.....265-266



PL Sejf z zamkiem cyfrowym
GB Safe with digital lock
D Seif mit Digitalschloss
RUS Сейф с электронным замком

CZ Pancéřová pokladna z digitálním zámkem
RO Seif cu broasca cu cifru
H Számzáras széf
E Caja de seguridad con cerradura digital



No.	cm	
78641	35x25x25	1

PL Skrzynka na klucze
GB Key box
D Schlüsselkasten
RUS Ящик для ключей
CZ Skříňka na klíče
RO Cutie pt. chei
H Kulcstartó doboz
E Caja para llaves

200x160x78 mm

2x

15x HOOKS HACZYKÓW



No.	size / rozmiar (mm)	
78432	200x160x78	20

PL Skrzynka na klucze
GB Key box
D Schlüsselkasten
RUS Ящик для ключей

CZ Skříňka na klíče
RO Cutie pt. chei
H Kulcstartó doboz
E Caja para llaves

450x380x80 mm

2x

80x HOOKS HACZYKÓW



17



No.	size / rozmiar (mm)	
78436	450x380x80	5

PL Kasetka na pieniądze
GB Cash box
D Geldkassette
RUS Ящик для денег
CZ Kазета na peníze
RO Casetă (cutie) pt. bani
H Pénzes kazetta
E Caja para efectivo

200x160x90 mm

2x



No.	size / rozmiar (mm)	colour / kolor	
78622	200x160x90	●	10
78612	200x160x90	●	10

PL Sejf z zamkiem cyfrowym
GB Safe with digital lock
D Seif mit Digitalschloss
RUS Сейф с электронным замком

CZ Pancéřová pokladna z digitálním zámkem
RO Seif cu broasca cu cifru
H Számzáras széf
E Caja de seguridad con cerradura digital



No.	cm	
78642	31x20x20	1

PL Skrzynka na klucze
GB Key box
D Schlüsselkasten
RUS Ящик для ключей

CZ Skříňka na klíče
RO Cutie pt. chei
H Kulcstartó doboz
E Caja para llaves

250x180x80 mm

2x

48x HOOKS HACZYKÓW



No.	size / rozmiar (mm)	
78434	250x180x80	10

PL Kasetka na pieniądze
GB Cash box
D Geldkassette
RUS Ящик для денег
CZ Kазета na peníze
RO Casetă (cutie) pt. bani
H Pénzes kazetta
E Caja para efectivo

150x120x80 mm

2x



No.	size / rozmiar (mm)	colour / kolor	
78620	150x120x80	●	20
78611	150x120x80	●	20

PL Kasetka na pieniądze
GB Cash box
D Geldkassette
RUS Ящик для денег
CZ Kазета na peníze
RO Casetă (cutie) pt. bani
H Pénzes kazetta
E Caja para efectivo

200x160x90 mm

CODE SZYFR



No.	size / rozmiar (mm)	colour / kolor	
78624	200x160x90	●	10
78613	200x160x90	●	10

- PL Kasetka na pieniądze
- GB Cash box
- D Geldkassette
- RUS Ящик для денег
- CZ Kasetá na peníze
- RO Casetá (cutie) pt. bani
- H Pénzes kassetta
- E Caja para efectivo

A5
SIZE
ROZMIAR

250x200x90
mm

2x 



No.	size / rozmiar (mm)	colour / kolor	
78626	250x200x90	●	10
78614	250x200x90	●	10

- PL Kasetka na pieniądze
- GB Cash box
- D Geldkassette
- RUS Ящик для денег
- CZ Kasetá na peníze
- RO Casetá (cutie) pt. bani
- H Pénzes kassetta
- E Caja para efectivo

A4
SIZE
ROZMIAR

300x240x90
mm

2x 



No.	size / rozmiar (mm)	colour / kolor	
78630	300x240x90	●	10
78616	300x240x90	●	10

- PL Kłódka żeliwna
- GB Iron padlock
- D Vorhängeschloss
- RUS Замок навесной
- CZ Stavební visací zámek
- RO Lacăt pt. construcții
- H Óriás lakat
- E Candado de hierro fundido

3x 



No.	L (mm)	
77051	32	12/240
77052	38	6/240
77053	50	6/120
77054	63	6/60
77055	75	6/36

- PL Kasetka na pieniądze
- GB Cash box
- D Geldkassette
- RUS Ящик для денег
- CZ Kasetá na peníze
- RO Casetá (cutie) pt. bani
- H Pénzes kassetta
- E Caja para efectivo

A5
SIZE
ROZMIAR

250x180x90
mm

CODE
SZYFR



No.	size / rozmiar (mm)	colour / kolor	
78628	250x180x90	●	10
78615	250x180x90	●	10

- PL Kasetka na pieniądze
- GB Cash box
- D Geldkassette
- RUS Ящик для денег
- CZ Kasetá na peníze
- RO Casetá (cutie) pt. bani
- H Pénzes kassetta
- E Caja para efectivo

2x 



No.	size / rozmiar (mm)	colour / kolor	
78632	180x115x55	●	24
78633	240x155x55	●	20

- PL Kłódka żeliwna
- GB Iron padlock
- D Vorhängeschloss
- RUS Замок навесной
- CZ Stavební visací zámek
- RO Lacăt pt. construcții
- H Óriás lakat
- E Candado de hierro fundido

3x 



No.	L (mm)	
77061	32	12/120
77062	38	12/120
77063	50	6/60
77064	63	6/36

- PL Kłódka żeliwna powlekana
- GB Alloy covered iron padlock
- D Vorhängeschloss
- RUS Замок навесной
- CZ Stavební visací zámek
- RO Lacăt pt. construcții
- H Óriás lakat
- E Candado de hierro fundido

4x 



No.	L (mm)	
77004	40	12/96
77005	50	12/72
77006	60	12/48

- PL Klódka żeliwna
- GB Iron padlock
- D Vorhängeschloss
- RUS Замок навесной
- CZ Stavební visací zámek
- RO Lacăt pt. construcții
- H Óriás lakat
- E Candado de hierro fundido



No.	L (mm)	
77110	40	6/120
77120	50	6/60
77130	60	6/36
77140	75	6/36
77150	85	6/36

- PL Klódka trzpieniowa
- GB Alloy covered padlock
- D Vorhängeschloss
- RUS Стержневой навесной замок чугунный
- CZ Stavební visací zámek
- RO Lacăt pt. construcții
- H Óriás lakat
- E Candado de mandril de hierro fundido cubierto



No.	L (mm)	
77241	90	6/24

17

- PL Klódka mosiężna
- GB Plated brass padlock
- D Vorhängeschloss
- RUS Замок навесной латунный
- CZ Zámek visací mosazný
- RO Lacăt alama
- H Lakat sárgaréz
- E Candado de latón



No.	L (mm)	
77250	25	12/600
77300	30	12/480
77350	35	12/300
77400	40	12/240
77500	50	12/144
77600	60	12/144

- PL Klódka żeliwna
- GB Alloy covered iron padlock
- D Vorhängeschloss
- RUS Замок навесной
- CZ Stavební visací zámek
- RO Lacăt pt. construcții
- H Óriás lakat
- E Candado de hierro fundido



No.	L (mm)	
77230	40	6/72
77231	50	6/72
77232	60	6/48

- PL Klódka trzpieniowa
- GB Rectangular brass padlock
- D Messigvorhängeschloss
- RUS Стержневой навесной замок латунный
- CZ Visací zámek čepový
- RO Lacăt din alamă cu belciug drept
- H Réz hengerzárás u lakat
- E Candado de latón de mandril



No.	L (mm)	
77210	50	6/120
77211	65	6/96
77212	75	6/60
77213	90	6/36

- PL Klódka mosiężna
- GB Plated brass padlock
- D Vorhängeschloss
- RUS Замок навесной латунный
- CZ Zámek visací mosazný
- RO Lacăt alama
- H Lakat sárgaréz
- E Candado de latón



No.	L (mm)		<small>pcs packing</small>
77603	25	4	12/120

PL Kłódka sztyfowa
GB Brass combination padlock
D Vorhängeschloss
RUS Замок навесной
CZ Zámek visací s číselným klíčem
RO Lacat alama cu cifru
H Lakat sárgaréz számkombinációs
E Candado de latón

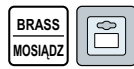

No.		
77607		12/120

PL Wkładka do zamka
GB Lock cylinder
D Schliesszylinder
RUS Личинка замка латунная

CZ Vložka na zámek
RO Yală pt. broască
H Zárbetét
E Inserción cromado



BRASS

MOSIADZ



No.	L (mm)	mm	key / klucz pcs	
77200	62	31/31	3	12/72
77203	72	31/41	3	12/72
77204	67	31/36	3	12/72
77205	87	36/51	3	12/72

PL Wkładka do zamka
GB Lock cylinder
D Schliesszylinder
RUS Личинка замка латунная

CZ Vložka na zámek
RO Yală pt. broască
H Zárbetét
E Inserción cromado



BRASS

MOSIADZ



No.	L (mm)	mm	key / klucz pcs	
77190	62	31/31	6	12/72
77191	67	31/36	6	12/72
77192	72	31/41	6	12/72
77193	87	36/51	6	12/72

PL Kłódka mosiężna
GB Plated brass padlock
D Vorhängeschloss
RUS Замк

CZ Zámek visací mosazný
RO Lacet alama
H Lakat sárgaréz
E Candado de latón



No.	mm	
77700	40x105	12/240

PL Wkładka do zamka chromowana
GB Lock cylinder
D Schliesszylinder
RUS Личинка замка

CZ Vložka na zámek
RO Yală pt. broască
H Zárbetét
E Inserción cromado



BRASS

MOSIADZ



No.	L (mm)	mm	key / klucz pcs	
77170	62	31/31	3	12/72
77171	67	31/36	3	12/72

PL Wkładka do zamka chromowana
GB Lock cylinder
D Schliesszylinder
RUS Личинка замка

CZ Vložka na zámek
RO Yală pt. broască
H Zárbetét
E Inserción cromado



BRASS

MOSIADZ



No.	L (mm)	mm	key / klucz pcs	
77180	62	31/31	6	12/72

- PL Zamek wpuszczany bębnowy
 GB Mortise lock for keyed cylinder and universal strike plate
 D Zylinder-Einbauschloss
 RUS Замок врезной цилиндрический
- CZ Zámek zadlabací vložkový
 RO Broască cu cilindru
 H Cilindres bevesőzár
 E Cerradura empotrada de tambor

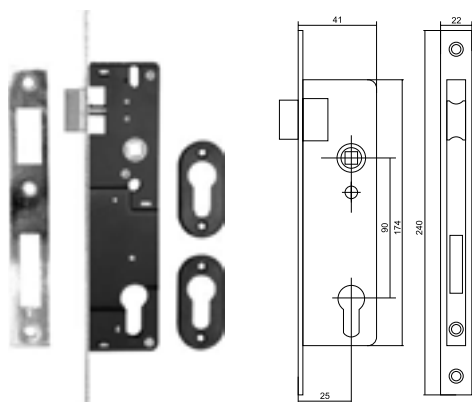

- PL Zamek wpuszczany bębnowy
 GB Mortise lock for keyed cylinder and universal strike plate
 D Zylinder-Einbauschloss
 RUS Замок врезной цилиндрический
- CZ Zámek zadlabací vložkový
 RO Broască cu cilindru
 H Cilindres bevesőzár
 E Cerradura empotrada de tambor

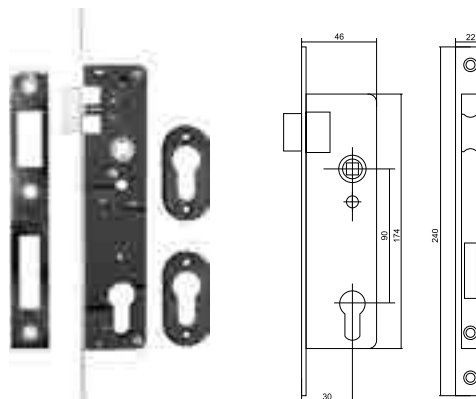

No.	mm	
78480	90/25	6/24

- PL Zamek wpuszczany bębnowy
 GB Mortise lock for keyed cylinder and universal strike plate
 D Zylinder-Einbauschloss
 RUS Замок врезной цилиндрический
- CZ Zámek zadlabací vložkový
 RO Broască cu cilindru
 H Cilindres bevesőzár
 E Cerradura empotrada de tambor

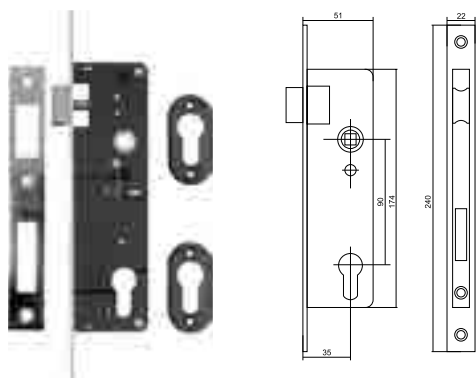

No.	mm	
78481	90/30	6/24

- PL Zamek wpuszczany bębnowy
 GB Mortise lock for keyed cylinder and universal strike plate
 D Zylinder-Einbauschloss
 RUS Замок врезной цилиндрический
- CZ Zámek zadlabací vložkový
 RO Broască cu cilindru
 H Cilindres bevesőzár
 E Cerradura empotrada de tambor

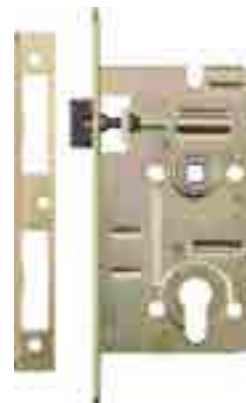
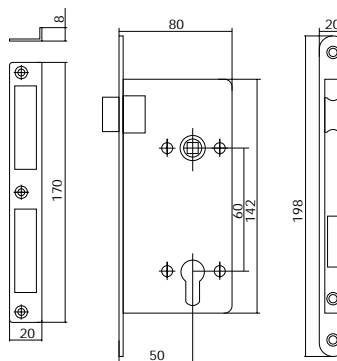

No.	mm	
78482	90/35	6/36



No.	mm	
78490	60/50	6/36

PL Zamek wpuszczany na klucz
 GB Mortise lock with lever mechanism and universal strike plate
 D Einbauschloss für Schlüssel
 RUS Замок врезной под ключ

CZ Zámek zadlabací na klíč
 RO Broască uşă cu cheie
 H Bevésőzár, kulcsos
 E Cerradura empotrada de llave

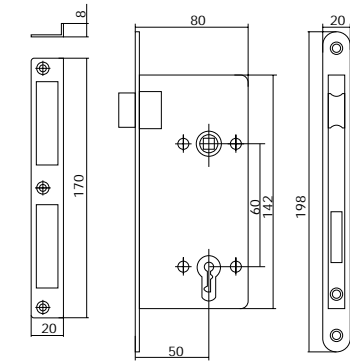

No.	mm	
78491	60/50	6/36

PL Zamek wpuszczany bębnowy
 GB Mortise lock for keyed cylinder and universal strike plate
 D Zylinder-Einbauschloss
 RUS Замок врезной цилиндровый

CZ Zámek zadlabací vložkový
 RO Broască cu cilindru
 H Cilindres bevésőzár
 E Cerradura empotrada de tambor

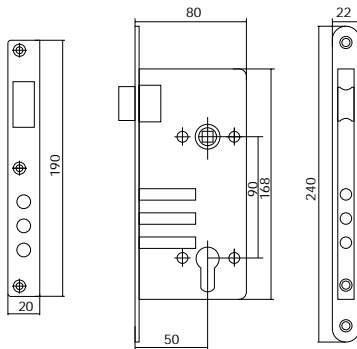

No.	mm	
78511	90/50	6/24

PL Zamek wpuszczany na klucz
 GB Mortise lock with lever mechanism and universal strike plate
 D Einbauschloss für Schlüssel
 RUS Замок врезной под ключ

CZ Zámek zadlabací na klíč
 RO Broască uşă cu cheie
 H Bevésőzár, kulcsos
 E Cerradura empotrada de llave

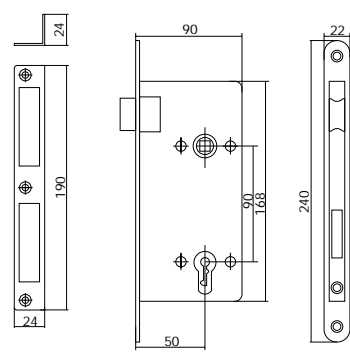

No.	mm	
78501	90/50	6/24

PL Zamek wpuszczany
 GB Mortise lock for keyed cylinder with latch and bolt
 D Einbauschloss
 RUS Замок врезной

CZ Zámek zadlabací
 RO Yalı uşă
 H Bevésőzár
 E Cerradura empotrada

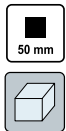
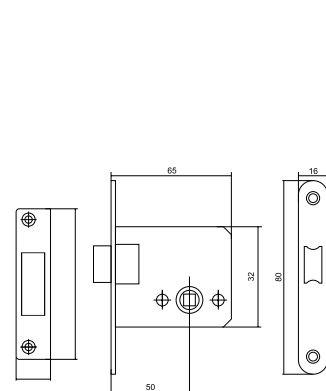

No.	mm	
78520	50	12/72

- PL Zamek wpuszczany łazienkowy
 GB Mortise lock with one side knob and universal strike plate
 D Einbauschloss für Badezimmer
 RUS Замок врезной для ванной комнаты
- CZ Zámek zadlabací pro koupelny
 RO Broască uşă baie
 H Bevésőzár, fürdőszobai
 E Cerradura empotrada para baños

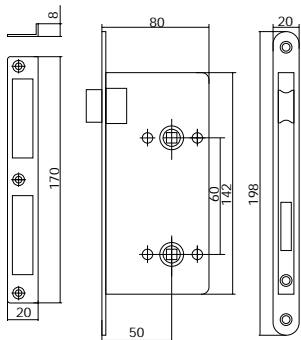

No.	mm	
78525	60/50	6/36

- PL Łańcuch do drzwi
 GB Safety chain
 D Türsicherungskette
 RUS Замок-цепь для двери
- CZ Řetěz na dveře
 RO Lanț pt. uşă
 H Ajtólánc
 E Cadena para puerta



No.		
77900		12/120

- PL Automatyyczny zamykacz do drzwi
 GB Door closer
 D Automatischer Türschließer
 RUS Доводчик дверной
- CZ Automatický zavírač dveří
 RO Încuietoare automată uşă
 H Ajtófék
 E Muelle de puerta

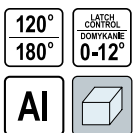

No.	kg	
78463	45-65	10

- PL Zamek wpuszczany łazienkowy
 GB Mortise lock with one side knob and universal strike plate
 D Einbauschloss für Badezimmer
 RUS Замок врезной для ванной комнаты
- CZ Zámek zadlabací pro koupelny
 RO Broască uşă baie
 H Bevésőzár, fürdőszobai
 E Cerradura empotrada para baños

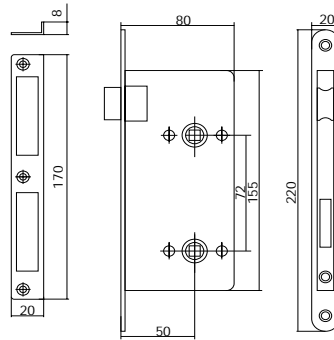

No.	mm	
78526	72/50	6/36

- PL Łańcuch do drzwi
 GB Safety chain
 D Türsicherungskette
 RUS Замок-цепь для двери
- CZ Řetěz na dveře
 RO Lanț pt. uşă
 H Ajtólánc
 E Cadena para puerta



No.		
77910		12/120

- PL Wizjer z klapką
 GB Door peep hole with flap
 D Türspion
 RUS Глазок дверной с заслонкой
- CZ Hledáček s klapkou
 RO Vizor cu clapă
 H Kitékintő, fedéllel
 E Mirilla con tapa



No.	mm	angle / kąt	
77920	35-50	200°	40/480

- PL Wizjer z klapką
 GB Door peep hole with flap
 D Türspion
 RUS Глазок дверной с заслонкой
- CZ Hledáček s klapkou
 RO Vizor cu clăpiță
 H Kitekintő, fedéllel
 E Mirilla con tapa



No.	mm	angle / kať	
77921	35-50	200°	40/480

- PL Linka rowerowa
 GB Bicycle lock
 D Fahrradschloss
 RUS Замок велосипедный
- CZ Zámek jízdního kola
 RO Antifurt pt. bicicleta
 H Kerékpárzár
 E Cable antirrobo para bicicletas



No.	L (cm)	Ø (mm)	colour / kolor	
77830	65	8		12/120

- PL Linka rowerowa
 GB Bicycle lock
 D Fahrradschloss
 RUS Замок велосипедный
- CZ Zámek jízdního kola
 RO Antifurt pt. bicicleta
 H Kerékpárzár
 E Cable antirrobo para bicicletas



No.	L (cm)	Ø (mm)	colour / kolor	
77833	120	8		10/60
77834	120	10		10/60
77835	180	10		10/60

- PL Linka rowerowa
 GB Bicycle lock
 D Fahrradschloss
 RUS Замок велосипедный
- CZ Zámek jízdního kola
 RO Antifurt pt. bicicleta
 H Kerékpárzár
 E Cable antirrobo para bicicletas



No.	L (cm)	Ø (mm)	colour / kolor	
77845	120	10		20/40

- PL Zawieszki plastikowe do kluczy
 GB Key indicators
 D Schlüsselanhänger
 RUS Брелок для ключей
- CZ Přívěšek na klíče
 RO Breloc
 H Kulcstartó
 E Llaveros de plástico

12
PCS



No.	pcs packing	
77930	12	12/120

- PL Linka rowerowa
 GB Bicycle lock
 D Fahrradschloss
 RUS Замок велосипедный
- CZ Zámek jízdního kola
 RO Antifurt pt. bicicleta
 H Kerékpárzár
 E Cable antirrobo para bicicletas



No.	L (cm)	Ø (mm)	colour / kolor	
77831	65	8		12/120

- PL Linka rowerowa
 GB Bicycle lock
 D Fahrradschloss
 RUS Замок велосипедный
- CZ Zámek jízdního kola
 RO Antifurt pt. bicicleta
 H Kerékpárzár
 E Cable antirrobo para bicicletas



No.	L (cm)	Ø (mm)	colour / kolor	
77837	120	8		10/60
77838	150	10		10/60

- PL Linka rowerowa
 GB Bicycle lock
 D Fahrradschloss
 RUS Замок велосипедный
- CZ Zámek jízdního kola
 RO Antifurt pt. bicicleta
 H Kerékpárzár
 E Cable antirrobo para bicicletas



No.	L (cm)	Ø (mm)	colour / kolor	
77840	180	12		10/40

PL Linka stalowa z klódką
GB Security cable and lock
D Stahlseil, mit Vorhängeschloss
RUS Канат стальной с замком

CZ Ocelové lanko s visacím zámekm
RO Sârmă de oțel cu lacăt
H Drótkötél, lakattal
E Cuerda de acero con candado



VOREL

No.	L (m)	Ø (mm)	
77815	3	4	12/48

PL Zapięcie motocyklowe
GB Motorcycle lock
D Stahlgliederschloss
RUS Замок до мотоцикла

CZ Zámek na kolo
RO Anti-furt motocicletă
H Láncakát motorbiciklihez
E Candado para Moto



VOREL

No.	L (cm)	Ø (mm)	
77860	100	22	12

PL Zapięcie łańcuchowe z zamkiem
GB Chain lock
D Kettenschloss mit Schloss
RUS Цепь с замком

CZ Bezpečnostní řetěz se zámekm
RO Încuietoare lanț cu lacăt
H Kerékpár lakat
E Candado de cadena con cerradura



VOREL

No.	L (cm)	Ø (mm)	
77881	120	7	12

PL Zapięcie typu U-lock
GB U-type lock
D Bügelschloss
RUS Замок до мотоцикла

CZ Zámek na kolo „U” typ
RO Anti-furt tip „U”
H U-lakat motorbiciklihez
E Candado tipo „U”



VOREL

No.	L (cm)	Ø (mm)	
77872	30	15	5/10

PL Zapięcie rowerowe
GB Bicycle lock
D Fahrradschloss
RUS Замок велосипедный

CZ Zámek jízdního kola
RO Anti-furt pt. bicicleta
H Kerékpárzár
E Cable antirrobo para bicicletas



VOREL

No.	L (cm)	Ø (mm)	
77850	100	18	12/24

PL Zapięcie motocyklowe
GB Motorcycle lock
D Stahlgliederschloss
RUS Замок до мотоцикла

CZ Zámek na kolo
RO Anti-furt motocicletă
H Láncakát motorbiciklihez
E Candado para Moto



VOREL

No.	L (cm)	Ø (mm)	
77861	150	25	6/12

PL Zapięcie typu U-lock
GB U-type lock
D Bügelschloss
RUS Замок до мотоцикла

CZ Zámek na kolo „U” typ
RO Anti-furt tip „U”
H U-lakat motorbiciklihez
E Candado tipo „U”

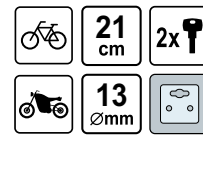

VOREL

No.	L (cm)	Ø (mm)	
77870	21	13	10/20

PL Zapięcie typu U-lock
GB U-type lock
D Bügelschloss
RUS Замок до мотоцикла

CZ Zámek na kolo „U” typ
RO Anti-furt tip „U”
H U-lakat motorbiciklihez
E Candado tipo „U”

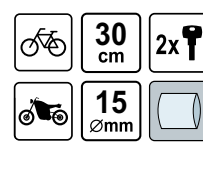

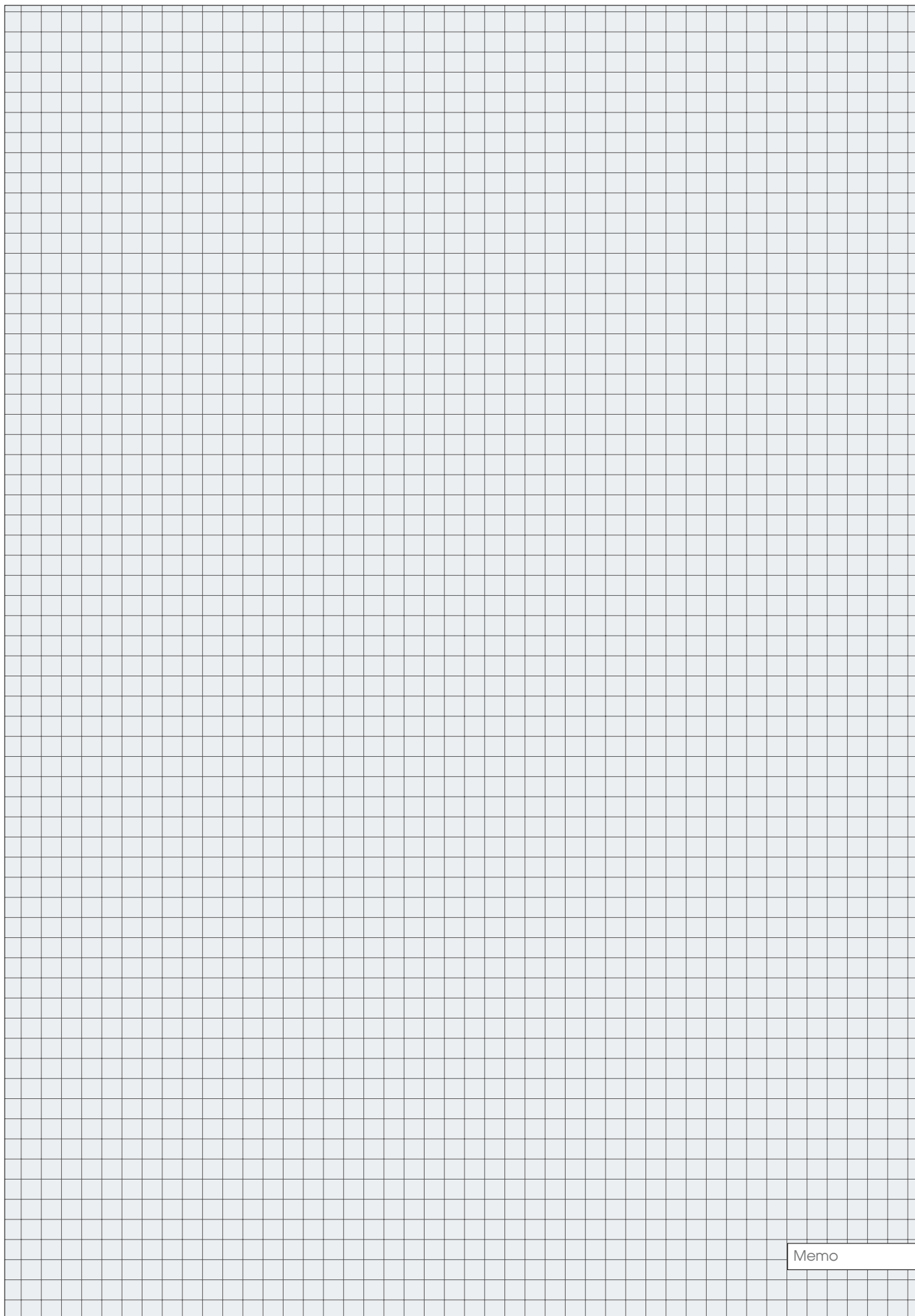

Memo



18

Tool bags & boxes Torby i skrzynki narzędziowe



Tool bags & boxes
Torby i skrzynki narzędziowe

.....270-272

Tool bags

Torby narzędziowe..... 270

Leather tool belts

Skórzane pasy narzędziowe..... 270

Plastic tool boxes

Plastikowe skrzynki narzędziowe..... 270

PL Torba narzędziowa
GB Tool bag
D Werkzeugkoffer
RUS Сумка для инструмента

CZ Nástrojová taška
RO Geantă pt. scule
H Szeszámotáska
E Maletin de herramientas



No.	dimensions / wymiary (mm)	
78700	380x250x110	4
78710	455x280x130	2

PL Torba narzędziowa
GB Tool bag
D Werkzeugkoffer
RUS Сумка для инструмента

CZ Nástrojová taška
RO Geantă pt. scule
H Szeszámotáska
E Maletin de herramientas



No.	dimensions / wymiary (mm)	
78730	400x260x140	2

PL Skrzynka narzędziowa
GB Tool box
D Plastikwerkzeugkoffer
RUS Ящик для инструмента-пластмассовый

CZ Nástrojová skříňka plastikov
RO Cutie din plastic pt. scule
H Szerszámosláda, műanyag
E Caja de herramientas de plástico



VOREL

No.	size / rozmiar	dimensions / wymiary (mm)	
78801	12" (30 cm)	312x167x130	1
78800	16" (40 cm)	415x226x200	1

PL Skrzynka narzędziowa
GB Tool box
D Plastikwerkzeugkoffer
RUS Ящик для инструмента-пластмассовый

CZ Nástrojová skříňka plastikov
RO Cutie din plastic pt. scule
H Szerszámosláda, műanyag
E Caja de herramientas de plástico



VOREL

No.	size / rozmiar	dimensions / wymiary (mm)	
78811	12" (30 cm)	312x167x130	1
78812	16" (40 cm)	415x226x200	1
78813	20" (50 cm)	525x256x246	1
78815	26" (65 cm)	595x337x316	1

PL Torba narzędziowa
GB Tool bag
D Werkzeugkoffer
RUS Сумка для инструмента

CZ Nástrojová taška
RO Geantă pt. scule
H Szeszámotáska
E Maletin de herramientas



No.	dimensions / wymiary (mm)	
78720	430x285x170	2

PL Pas monterski
GB Tool belt
D Leder-Gürteltasche
RUS Пояс монтажника кожаный

CZ Montéřský pás kožený
RO Centura port scule - piele
H Bőr szerszámcsöv
E Cinturon de montaje de piel



No.	
78750	50

PL Skrzynka narzędziowa
GB Tool box
D Plastikwerkzeugkoffer
RUS Ящик для инструмента-пластмассовый

CZ Nástrojová skříňka plastikov
RO Cutie din plastic pt. scule
H Szerszámosláda, műanyag
E Caja de herramientas de plástico



VOREL

No.	size / rozmiar	dimensions / wymiary (mm)	
78802	20" (50 cm)	525x256x246	1

PL Skrzynka narzędziowa
GB Tool box
D Plastikwerkzeugkoffer
RUS Ящик для инструмента-пластмассовый

CZ Nástrojová skříňka plastikov
RO Cutie din plastic pt. scule
H Szerszámosláda, műanyag
E Caja de herramientas de plástico



VOREL

No.	size / rozmiar	dimensions / wymiary (mm)	load capacity / noşność (kg)	
78814	20" (50 cm)	525x256x325	25 + 3	1

PL Szufladki warsztatowe
 GB Workshop drawers
 D Werkstattschubfächer
 RUS Ящички для инструментов
 CZ Skříňka se zásobníky
 RO Sertare atelier
 H Műhely zsámoly fiókkal
 E Cajones para taller



No.	dimensions / wymiary (mm)	compartments / szufladki	
78785	225x155x100	10	20

PL Organizer Domino
 GB Organizer
 D Werkzeugkaste
 RUS Органайзер
 CZ Organizér
 RO Cutie tip organizator
 H Mű. csavartartó doboz
 E Caja



No.	dimensions / wymiary (mm)	compartments / przegródki	
78793	120x100x30	8	38

PL Organizer
 GB Organizer
 D Werkzeugkaste
 RUS Органайзер
 CZ Organizér
 RO Cutie tip organizator
 H Mű. csavartartó doboz
 E Caja



No.	dimensions / wymiary (mm)	
78816	310x210x55	10
78818	350x250x55	10

PL Organizer
 GB Organizer
 D Werkzeugkaste
 RUS Органайзер
 CZ Organizér
 RO Cutie tip organizator
 H Mű. csavartartó doboz
 E Caja



No.	dimensions / wymiary (mm)	
78819	460x320	5

PL Organizer
 GB Organizer
 D Werkzeugkaste
 RUS Органайзер
 CZ Organizér
 RO Cutie tip organizator
 H Mű. csavartartó doboz
 E Caja



No.	dimensions / wymiary (mm)	compartments / przegródki	
78790	200x145x35	7	10

PL Organizer
 GB Organizer
 D Werkzeugkaste
 RUS Органайзер
 CZ Organizér
 RO Cutie tip organizator
 H Mű. csavartartó doboz
 E Caja



No.	dimensions / wymiary (mm)	compartments / przegródki	
78791	300x220x55	10	10

PL Organizer Domino
 GB Organizer
 D Werkzeugkaste
 RUS Органайзер
 CZ Organizér
 RO Cutie tip organizator
 H Mű. csavartartó doboz
 E Caja



No.	dimensions / wymiary (mm)	
78794	360x270	5

PL Pojemnik magazynowy
 GB Storage case
 D Lagersichtbox
 RUS Ящик для склада
 CZ Box skladovací
 RO Cutie scule diverse
 H Tárolók
 E Contenedeor de almacen



No.	type	dimensions / wymiary (mm)	
78821	P-1	108x110x75	40
78822	P-2	160x115x75	40
78824	P-4	235x173x125	20
78825	P-5	340x200x150	9
78826	P-6	440x315x180	6

PL Pojemnik magazynowy
 GB Container
 D Vorratsbehälter
 RUS Ящик складской

CZ Box skladovací
 RO Cutie depozitare
 H Tároló doboz
 E Caja de almacenamiento



No.	type / typ	dimensions / wymiary (mm)	
78830	XS	116x112x75	270
78831	S	116x161x75	190
78833	M	170x240x126	44
78834	L	204x340x155	27
78835	XL	333x500x187	7

PL Przykrywka do pojemnika magazynowego
 GB Container cover
 D Lagerbehälter Deckel
 RUS Крышка к ящику складскому

CZ Viko na kontejner
 RO Capac cutie de depozitare
 H Láda fedél
 E Tapa para recipiente



No.	dimensions / wymiary (mm)	for / dla	
78832	116x212x75	78831	54

Memo

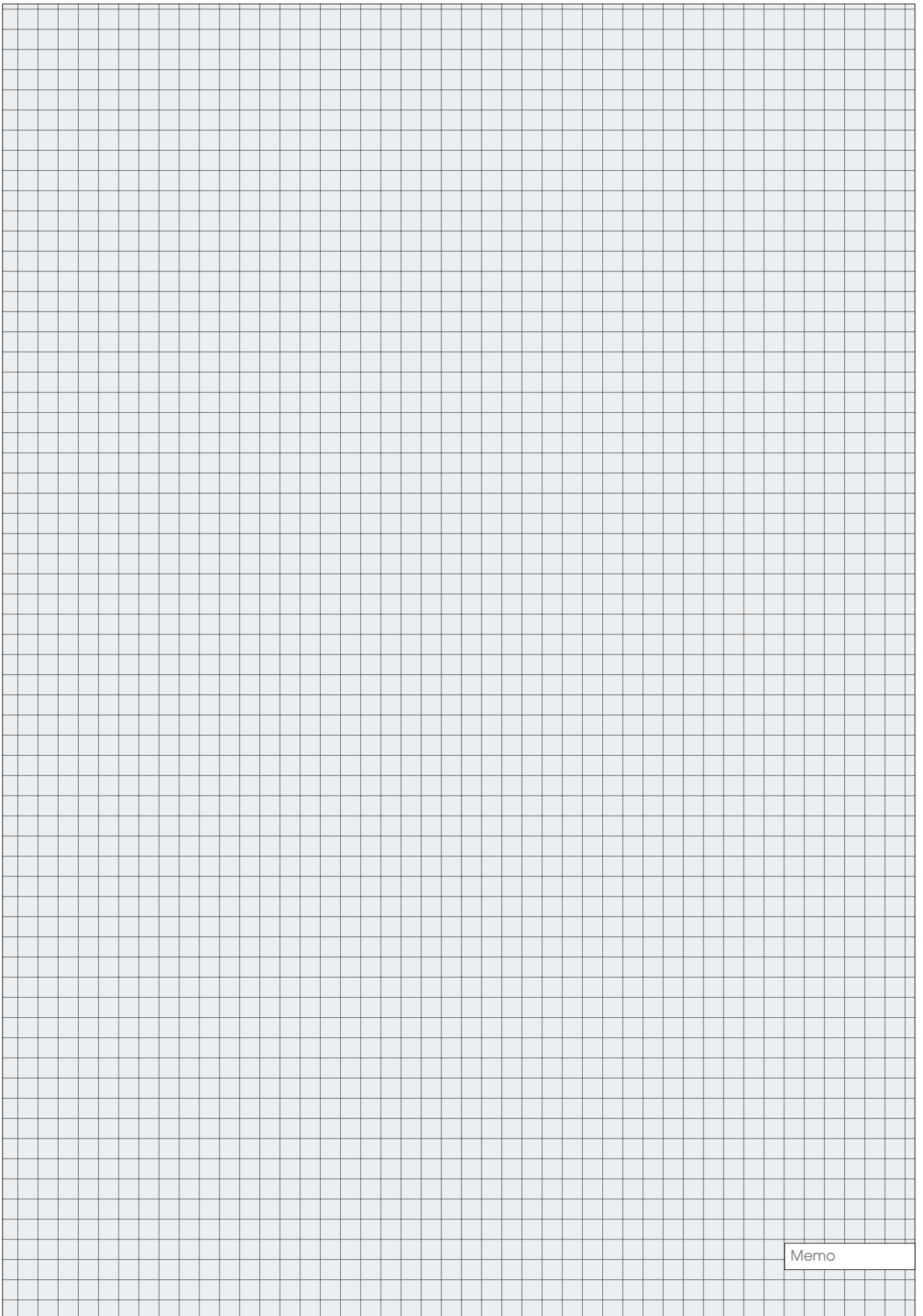

Memo

19

Bicycle accessories
Akcesoria rowerowe



Bicycle lamps
Lampy rowerowe

..... 276

**Bicycle & motorcycle locks**
Zamknięcia do rowerów i motocykli

..... 276-277

**Bicycle pumps**
Pompki rowerowe

..... 278-279

**Bicycle tools**
Narzędzia rowerowe

..... 279-280



- PL Lampa rowerowa przednia LED
 GB LED front bike light
 D Fahrrad Frontscheinwerfer LED
 RUS Светодиодный фонарик для велосипеда
- CZ Přední světla LED na kolo
 RO Lanterna pt. bicicleta LED
 H LED-es első kerékpár lámpa
 E Linterna LED frontal para bicicleta

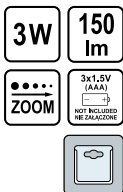

POWER LED



VOREL

No.	battery / bateria	
88411	3x1.5V	12/48

- PL Zestaw lamp rowerowych LED
 GB LED bike light set
 D Fahrrad-Beleuchtungsset LED
 RUS Набор светодиодных велосипедных фонарей
- CZ Set LED osvětlení na kolo
 RO Set lanterna bicicleta LED
 H LED kerékpár lámpa szett
 E Juego de luces LED para bicicleta

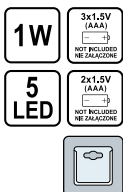

POWER LED



VOREL

No.	battery / bateria	
88421	3x1.5V / 2x1.5V	12/120

- PL Linka rowerowa
 GB Bicycle lock
 D Fahrradschloss
 RUS Замок велосипедный
- CZ Zámek jízdního kola
 RO Antifurt pt. bicicleta
 H Kerékpárzár
 E Cable antirrobo para bicicletas



VOREL

No.	L (cm)	Ø (mm)	colour / kolor	
77831	65	8	● ● ●	12/120

- PL Linka rowerowa
 GB Bicycle lock
 D Fahrradschloss
 RUS Замок велосипедный
- CZ Zámek jízdního kola
 RO Antifurt pt. bicicleta
 H Kerékpárzár
 E Cable antirrobo para bicicletas



VOREL

No.	L (cm)	Ø (mm)	colour / kolor	
77837	120	8	● ● ●	10/60
77838	150	10	● ● ●	10/60

- PL Zestaw lamp rowerowych LED
 GB LED bike light set
 D Fahrrad-Beleuchtungsset LED
 RUS Набор светодиодных велосипедных фонарей
- CZ Set LED osvětlení na kolo
 RO Set lanterna bicicleta LED
 H LED kerékpár lámpa szett
 E Juego de luces LED para bicicleta



POWER LED



VOREL

No.	battery / bateria	
88422	3x1.5V / 2x1.5V	12/48

- PL Linka rowerowa
 GB Bicycle lock
 D Fahrradschloss
 RUS Замок велосипедный
- CZ Zámek jízdního kola
 RO Antifurt pt. bicicleta
 H Kerékpárzár
 E Cable antirrobo para bicicletas

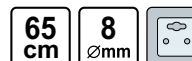

VOREL

No.	L (cm)	Ø (mm)	colour / kolor	
77830	65	8	● ● ●	12/120

- PL Linka rowerowa
 GB Bicycle lock
 D Fahrradschloss
 RUS Замок велосипедный
- CZ Zámek jízdního kola
 RO Antifurt pt. bicicleta
 H Kerékpárzár
 E Cable antirrobo para bicicletas



VOREL

No.	L (cm)	Ø (mm)	colour / kolor	
77833	120	8	● ● ●	10/60
77834	120	10	● ● ●	10/60
77835	180	10	● ● ●	10/60

- PL Linka rowerowa
 GB Bicycle lock
 D Fahrradschloss
 RUS Замок велосипедный
- CZ Zámek jízdního kola
 RO Antifurt pt. bicicleta
 H Kerékpárzár
 E Cable antirrobo para bicicletas

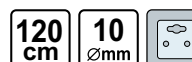

VOREL

No.	L (cm)	Ø (mm)	colour / kolor	
77845	120	10	● ● ●	20/40

- PL Linka rowerowa
GB Bicycle lock
D Fahrradschloss
RUS Замок велосипедный
- CZ Zámek jízdního kola
RO Antifurt pt. bicicleta
H Kerékpárzár
E Cable antirrobo para bicicletas



No.	L (cm)	Ø (mm)	colour / kolor	📦
77840	180	12	●●●	10/40

- PL Zapięcie rowerowe
GB Bicycle lock
D Fahrradschloss
RUS Замок велосипедный
- CZ Zámek jízdního kola
RO Antifurt pt. bicicleta
H Kerékpárzár
E Cable antirrobo para bicicletas



No.	L (cm)	Ø (mm)	📦
77850	100	18	12/24

- PL Zapięcie motocyklowe
GB Motorcycle lock
D Stahlgliederschloss
RUS Замок до мотоцикла
- CZ Zámek na kolo
RO Anti-furt motocicletă
H Láncakát motorbiciklihez
E Candado para Moto



No.	L (cm)	Ø (mm)	📦
77861	150	25	6/12

- PL Zapięcie typu U-lock
GB U-type lock
D Bügelschloss
RUS Замок до мотоцикла
- CZ Zámek na kolo „U” typ
RO Anti-furt tip „U”
H U-lakat motorbiciklihez
E Candado tipo „U”



No.	L (cm)	Ø (mm)	📦
77870	21	13	10/20

- PL Linka stalowa z klódką
GB Security cable and lock
D Stahlseil, mit Vorhängeschloss
RUS Канат стальной с замком
- CZ Ocelové lanko s visacím zámekem
RO Sârmă de oțel cu lacăt
H Drótkötél, lakattal
E Cuerda de acero con candado



No.	L (m)	Ø (mm)	📦
77815	3	4	12/48

- PL Zapięcie motocyklowe
GB Motorcycle lock
D Stahlgliederschloss
RUS Замок до мотоцикла
- CZ Zámek na kolo
RO Anti-furt motocicletă
H Láncakát motorbiciklihez
E Candado para Moto

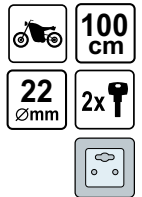

No.	L (cm)	Ø (mm)	📦
77860	100	22	12

- PL Zapięcie łańcuchowe z zamkiem
GB Chain lock
D Kettenschloss mit Schloss
RUS Цепь с замком
- CZ Bezpečnostní řetěz se zámekem
RO Încuietoare lanț cu lacăt
H Kerékpár lakat
E Candado de cadena con cerradura



No.	L (cm)	Ø (mm)	📦
77881	120	7	12

- PL Zapięcie typu U-lock
GB U-type lock
D Bügelschloss
RUS Замок до мотоцикла
- CZ Zámek na kolo „U” typ
RO Anti-furt tip „U”
H U-lakat motorbiciklihez
E Candado tipo „U”



No.	L (cm)	Ø (mm)	📦
77872	30	15	5/10

- PL Teleskopowa pompka aluminiowa
 GB Double cylinder aluminium hand pump
 D Aluminium Handpumpe Doppelzylinder
 RUS Насос телескопический алюминиевый
- CZ Pumpa ruční double-pístové hliníkové
 RO Pompa Aluminium duo telescope
 H Pumpa aluminium dupla dugattyús
 E Bomba de mano de doble cilindro de aluminio



No.		
82031		60

- PL Pompka nożna z manometrem
 GB Foot pump with manometer
 D Fussluftpumpe mit Manometer
 RUS Насос ножной с манометром
- CZ Nožní pumpa z manometrem
 RO Pompă de picior cu manometru
 H Lábpumpa nyomásmérővel
 E Bomba de pierna con manometro



No.		
82001		20

- PL Pompka tłokowa nożna
 GB Foot pump
 D Fussluftpumpe mit Manometer
 RUS Насос ножной с манометром
- CZ Nožní pumpa z manometrem
 RO Pompă de picior
 H Lábpumpa nyomásmérővel
 E Bomba de pierna con manometro

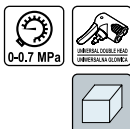

No.	MPa	
82005	0.7	5

- PL Pompka tłokowa nożna
 GB Foot pump
 D Fussluftpumpe mit Manometer
 RUS Насос ножной с манометром
- CZ Nožní pumpa z manometrem
 RO Pompă de picior
 H Lábpumpa nyomásmérővel
 E Bomba de pierna con manometro



No.	MPa	
82015	0-0.7	6

- PL Pompka słupkowa ręczna
 GB Hand pump
 D Hand-Luftpumpe
 RUS Насос ручной
- CZ Hustička ruční
 RO Pompa de mana cu manometru
 H Kézi pumpa
 E Bomba de barrote de mano



No.	MPa	
82020	0.3	20

- PL Pompka słupkowa z manometrem
 GB Hand pump with manometer
 D Hand-Luftpumpe mit Manometer
 RUS Насос ручной с манометром
- CZ Pumpa z manometrem
 RO Pompa de mana cu manometru
 H Kézi pumpa manométerrel
 E Bomba de barrote con manometro



No.	MPa	
82021	1	10

- PL Pompka rowerowa
 GB Bike hand pump
 D Fahrradpumpe
 RUS Велосипед ручной насос
- CZ Pumpička na kolo
 RO Pompă de bicicletă
 H Kerékpár pumpa
 E Bomba de bicicleta



No.		
82032		60

- PL Pompka tłokowa nożna
 GB Foot pump
 D Fussluftpumpe mit Manometer
 RUS Насос ножной с манометром
- CZ Nožní pumpa z manometrem
 RO Pompă de picior
 H Lábpumpa nyomásmérővel
 E Bomba de pierna con manometro



- PL Pompka słupkowa z manometrem
 GB Hand pump with manometer
 D Hand-Luftpumpe mit Manometer
 RUS Насос ручной с манометром
 CZ Pumpa z manometrem
 RO Pompa de mana cu manometru
 H Kézi pumpa manométerrel
 E Bomba de barrote con manometro



No.	MPa	Box
82022	0.1-1	10

- PL Zestaw kluczy imbusowych
 GB Hex key set
 D Sechskant-Stiftschluselsatz
 RUS Набор шестигранных
- CZ Imbusové klíče
 RO Chei imbus
 H Imbisz kulcs
 E Juego de llaves hex



No.	mm	pcs	Box
56505	1.5; 2; 2.5; 3; 4; 5; 6; 8	8	25/100

- PL Zestaw kluczy imbusowych
 GB Hex key set
 D Sechskant-Stiftschluselsatz
 RUS Набор шестигранных
- CZ Imbusové klíče
 RO Chei imbus
 H Imbisz kulcs
 E Juego de llaves hex



No.	mm	pcs	Box
56506	1.5; 2; 2.5; 3; 4; 5; 6; 8	8	25/100

- PL Zestaw do naprawy roweru
 GB Bike hand tool set
 D Fahrrad-Reparatur-Satz
 RUS Набор инструментов для велосипеда
 CZ Cyklistické nářadí
 RO Instrumente ciclism
 H Kerékpár szerszámok
 E Herramientas Ciclismo



- Set includes / Zestaw zawiera:
- Hex key / Klucze imbusowe: 4mm, 5mm, 6mm
 - Ratchet screwdriver / Wkrętak z grzechotką
 - Adjustable wrench / Klucz nastawny
 - Crowbar / Łyzki do opon rowerowych: x2
 - Sockets / Nasadki: 8mm, 9mm, 10mm
 - Wheels spokes wrench / Klucz do regulacji szprych
 - Bits set + adaptor / Zestaw końcówek wkrętakowych + adapter
 - Tire repair kit / Zestaw naprawy do dętek



No.	Box
77795	20

- PL Zestaw kluczy Torx
 GB Torx key set
 D Torx-Stiftschluselsatz
 RUS Набор ключей Torx
- CZ Souprava klíčů Torx
 RO Set de chei Torx
 H Kulcskészlet, Torx
 E Juego de llaves Torx

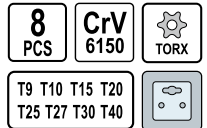

No.	pcs	Box
56507	8	25/100

- PL Stojak do obsługi rowerów
- GB Bike repair stand
- D Fahrrad Montageständer
- RUS Стенд для ремонта велосипедов
- CZ Montážní stojan
- RO Stand pt. repararea bicicletei
- H Kerékpár szerelő
- E Soporte de reparación



- 105-145 cm
- 360°
- max 30 kg
- 25-80 mm
- Box icon



No.

77715



2

Memo

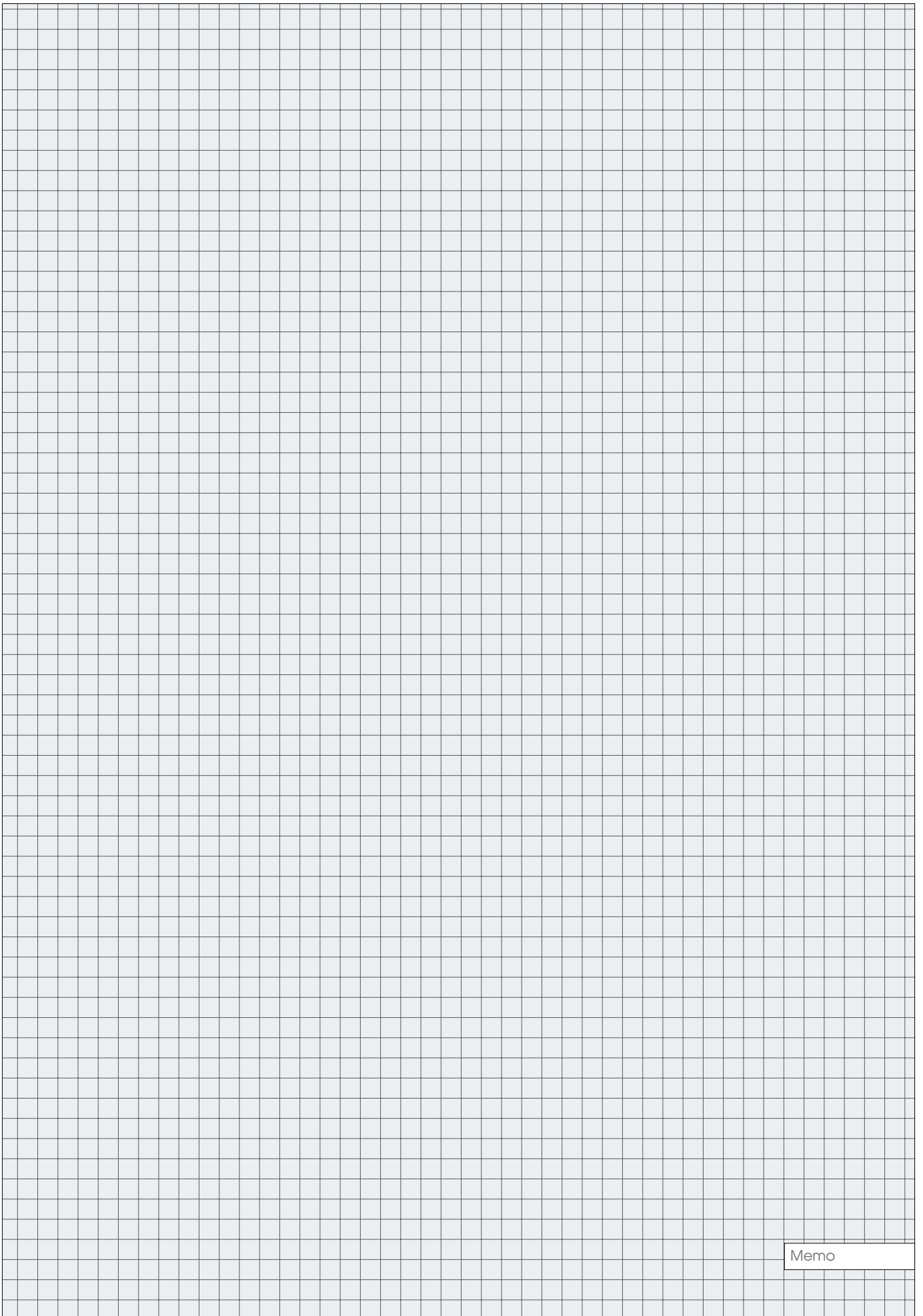





Memo

20

Household equipment
Gospodarstwo domowe



Mailboxes Skrzynki na listy	284-285	Pumps Pompki	295
Coal stoves & accessories Pieczyki węglowe i akcesoria	285-288	Hydraulic accessories Akcesoria hydrauliczne	295-296
Brushes Szczotki	289-290	Vaselines Wazeliny techniczne	296
Mops Zgarniacze do wody	290	Hand trucks Wózki magazynowe	296-297
Multipurpose trays Podstawki gospodarcze	290	Casters Kółka	297-299
Snow shovels Łopaty do śniegu	290	Seals Uszczelnienia	299-300
Bags Worki	291-293	Self-adhesive furniture pads Podkładki samoprzylepne pod meble	300-303
Tarpaulins Plandeki	293	Plastic stools Stołki plastikowe	303
Vacuum cleaners, ash separators & accessories Odkurzacze, separatory popiołu i akcesoria	293-295	Hooks & furniture protection Haczyki i zabezpieczenia	303-307
Syphon pumps Pompy syfonowe	295	Hooks Wieszaki	307
			Cable organizers Organizery do kabli	307

- PL Skrzynka na listy
- GB Mailbox
- D Briefkasten
- RUS Почтовый ящик
- CZ Schránka na dopisy
- RO Cutie poştală
- H Levélláda
- E Buzón



285x200x60
mm



No.	size / rozmiar (mm)	slot width / szerokość wrzutu (mm)	colour / kolor	
78540	285x200x60	143	●	12
78541	285x200x60	143	●	12
78542	285x200x60	143	●	12
78543	285x200x60	143	●	12

- PL Skrzynka na listy
- GB Mailbox
- D Briefkasten
- RUS Почтовый ящик
- CZ Schránka na dopisy
- RO Cutie poştală
- H Levélláda
- E Buzón



400x250x100
mm



No.	size / rozmiar (mm)	slot width / szerokość wrzutu (mm)	colour / kolor	
78570	400x250x100	230	●	6
78571	400x250x100	230	●	6
78572	400x250x100	230	●	6

- PL Skrzynka na listy
- GB Mailbox
- D Briefkasten
- RUS Почтовый ящик
- CZ Schránka na dopisy
- RO Cutie poştală
- H Levélláda
- E Buzón



380x320x105
mm



No.	size / rozmiar (mm)	slot width / szerokość wrzutu (mm)	colour / kolor	
78580	380x320x105	220	●	5
78581	380x320x105	220	●	5
78582	380x320x105	220	●	5

- PL Skrzynka na listy
- GB Mailbox
- D Briefkasten
- RUS Почтовый ящик
- CZ Schránka na dopisy
- RO Cutie poştală
- H Levélláda
- E Buzón



360x260x80
mm



No.	size / rozmiar (mm)	slot width / szerokość wrzutu (mm)	colour / kolor	
78555	360x260x80	220	●	6
78556	360x260x80	220	●	6
78557	360x260x80	220	●	6

- PL Skrzynka na listy
- GB Mailbox
- D Briefkasten
- RUS Почтовый ящик
- CZ Schránka na dopisy
- RO Cutie poştală
- H Levélláda
- E Buzón



310x360x100
mm



No.	size / rozmiar (mm)	slot width / szerokość wrzutu (mm)	colour / kolor	
78575	310x360x100	320	●	6
78576	310x360x100	320	●	6
78577	310x360x100	320	●	6

- PL Skrzynka na listy
- GB Mailbox
- D Briefkasten
- RUS Почтовый ящик
- CZ Schránka na dopisy
- RO Cutie poştală
- H Levélláda
- E Buzón



380x320x105
mm



No.	size / rozmiar (mm)	slot width / szerokość wrzutu (mm)	colour / kolor	
78585	380x320x105	220	●	5
78586	380x320x105	220	●	5
78587	380x320x105	220	●	5

PL Skrzynka na listy
GB Mailbox
D Briefkasten
RUS Почтовый ящик

CZ Schránka na dopisy
RO Cutie poştală
H Levélláda
E Buzón

480x280x80
mm

2x



No.	size / rozmiar (mm)	slot width / szerokość wrzutu (mm)	colour / kolor	
78590	480x280x80	198	●	5
78591	480x280x80	198	●	5
78592	480x280x80	198	●	5

PL Piecyk węglowy
GB Coal stove
D Kohleofen
RUS Угольная печь

CZ Kamna na uhlí
RO Soba
H Szemes kályha
E Calentador de carbón



No.	type / typ	kW	chamottes quantity / ilość szamotów	weight / waga (kg)	
72989	W2T	5	3	19	8

PL Piec grzewczy
GB Heating stove
D Heizofen
RUS Печное отопление

CZ Vytápění kamna
RO Sobă de încălzire
H Kályha
E Estufa de calefacción



No.	type / typ	kW	weight / waga (kg)	
73002	SZW6G	6	51	4

PL Piecyk węglowy
GB Coal stove
D Kohleofen
RUS Угольная печь

CZ Kamna na uhlí
RO Soba
H Szemes kályha
E Calentador de carbón



No.	type / typ	kW	chamottes quantity / ilość szamotów	weight / waga (kg)	
72988	W3T	6	5	26	8

PL Piecyk węglowy
GB Coal stove
D Kohleofen
RUS Угольная печь

CZ Kamna na uhlí
RO Soba
H Szemes kályha
E Calentador de carbón



No.	type / typ	kW	chamottes quantity / ilość szamotów	weight / waga (kg)	
72990	W4T	6	7	27	8

PL Piec grzewczy
GB Heating stove
D Heizofen
RUS Печное отопление

CZ Vytápění kamna
RO Sobă de încălzire
H Kályha
E Estufa de calefacción



No.	type / typ	kW	weight / waga (kg)	
73003	SZW6T	6	51	4

PL Piec grzewczy CZ Vytápění kamna
 GB Heating stove RO Sobă de încălzire
 D Heizofen H Kályha
 RUS Печное отопление E Estufa de calefacción



VOREL

No.	type / typ	kW	weight / waga (kg)	
73004	W5T	5	49	8

PL Piec grzewczy CZ Vytápění kamna
 GB Heating stove RO Sobă de încălzire
 D Heizofen H Kályha
 RUS Печное отопление E Estufa de calefacción



VOREL

No.	type / typ	kW	weight / waga (kg)	
73006	SZP5G	8	61	4

PL Blacha przypieczowa malowana
 GB Painted stove metal plate
 D Brennblech, mit Farbansrich
 RUS Оцинкованный окрашенный лист для обшивки печи
 CZ Podložka pod pec z lakovaného plechu
 RO Tablă sobă vopsită
 H Festett hő terelő lemez kályhához
 E Chapa pintada para estufa



VOREL

No.	size / rozmiar (mm)	thickness / grosime (mm)	
72936	476x603	0.5	10
72937	476x800	0.5	10

PL Piec grzewczy CZ Vytápění kamna
 GB Heating stove RO Sobă de încălzire
 D Heizofen H Kályha
 RUS Печное отопление E Estufa de calefacción



VOREL

No.	type / typ	kW	weight / waga (kg)	
73005	SZW5T	5	47	8

PL Blacha przypieczowa ocynkowana
 GB Galvanized stove metal plate
 D Brennblech, verzinkt
 RUS Оцинкованный лист для обшивки печи
 CZ Podložka pod pec z pozinkovaného plechu
 RO Tablă sobă zincat
 H Galvanizált hő terelő lemez kályhához
 E Chapa galvanizada para estufa



VOREL

No.	size / rozmiar (mm)	thickness / grosime (mm)	
72933	305x475	0.5	10
72934	396x600	0.5	10
72935	485x663	0.5	10

PL Wycior kominowy CZ Kartáč kominový
 GB Chimney cleaner RO Racletă pt. coșul de fum
 D Schornsteinreiniger H Kéménytisztító kefe
 RUS Щетка для трубочистов E Anilla para baquetas de calefacción central



No.	Ø (mm)	
72948	120	15
72950	150	20
72951	175	18
72952	200	18

PL Wycior kominowy
GB Chimney cleaner
D Schornsteinreiniger
RUS Щетка для трубочистов

CZ Kartáč kominový
RO Racletă pt. coșul de fum
H Kéménytisztító kefe
E Arilla para baquetas de calefacción central



VOREL

No.	Ø (mm)	
72953	250	12
72954	300	8

PL Kula kominarska
GB Chimneysweep ball
D Schornsteinfegekugel
RUS Гиря для трубочистов

CZ Kaminkrčičo kamuolys
RO Bilă pt. coșul de fum
H Kémény golyó
E Esfera del dehollinador



No.		
72938	K15	4
72939	K25	4

PL Drut kominowy
GB Chimney wire
D Schornsteinraht
RUS Проволока для трубочистов

CZ Kaminkrčičio trosas
RO Sârmă pt. coșul de fum
H Kéménytisztító drót
E Alambre de chimeneas



No.	Ø (mm)	L (m)	
72942	3.5	6	25
72943	3.5	8	20
72944	3.5	10	20
72945	3.5	12	20

PL Wycior kominowy
GB Chimney cleaner
D Schornsteinreiniger
RUS Щетка для трубочистов

CZ Kartáč kominový
RO Racletă pt. coșul de fum
H Kéménytisztító kefe
E Arilla para baquetas de calefacción central



VOREL

No.	Ø (mm)	
72994	120	15
72995	150	20
72996	175	18
72997	200	18
72998	250	12

PL Pręt do wyciorów
GB Central heating cleaning rod
D Stab für die Reiniger der Zentralheizung
RUS Черенок для щеток – центральное отопление

CZ Tyč k čistění
RO Tije pt. racleji încalzire centrală
H CO pálca a füstcsótisztító keféhez
E Baqueta para limpiar el sistema de calefacción central



No.	Ø (mm)	L (mm)	
72956	7	600	50
72958	7	800	50
72960	7	1000	50

PL Wycior do C.O.
GB Chimney cleaner
D Schornsteinreiniger
RUS Щетка для трубочистов

CZ Kartáč kominový
RO Racletă pt. coșul de fum
H Kéménytisztító kefe
E Arilla para baquetas de calefacción central



No.	Ø (mm)	
72963	30	50
72964	40	50
72965	50	50
72966	60	35
72967	70	35
72968	80	30
72969	90	20
72970	100	20

PL Szufelka angielska
GB Shovel
D Schaufel
RUS Совок

CZ Lopatka
RO Lopățică
H Lapát
E Pala



No.	mm	
72974	340x200	18

PL Szufelka gospodarcza
GB Shovel
D Schaufel
RUS Совок

CZ Lopatka
RO Lopățică
H Lapát
E Pala



VOREL

No.	mm	
72976	380x220	20

PL Szufelka szeroka
GB Shovel
D Schaufel
RUS Совок

CZ Lopatka
RO Lopățică
H Lapát
E Pala



No.	mm	
72975	460x220	40

PL Węglarka duża
GB Coal carrier
D Kohlenkasten
RUS Ведро для угля

CZ Uhlák
RO Rezervor de cărbuni pt. sobă
H Szenekosár
E Carbonera



No.	L (mm)	W (mm)	H (mm)	
72984	420	230	205	5

PL Pogrzebacz
GB Poker
D Schüreisen
RUS Кочерга

CZ Pohrabáč
RO Vătrași
H Piszkavas
E Hurgón



No.	L (mm)	
72981	620	50

PL Szufelka
GB Shovel
D Schaufel
RUS Совок

CZ Lopatka
RO Lopățică
H Lapát
E Pala



No.	mm	
72977	550x180	30
72978	490x140	40

PL Szufelka mala
GB Shovel
D Schaufel
RUS Совок

CZ Lopatka
RO Lopățică
H Lapát
E Pala



No.	mm	
72979	500x110	5/30

PL Węglarka mala
GB Coal carrier
D Kohlenkasten
RUS Ведро для угля

CZ Uhlák
RO Rezervor de cărbuni pt. sobă
H Szenekosár
E Carbonera



No.	L (mm)	W (mm)	H (mm)	
72985	340	200	175	5

PL Miotla
GB Broom
D Strassenbesen
RUS Метла

CZ Metla
RO Matura
H Partvis
E Cepillo pelo largo



No.	mm	
35867	300x65	10
35868	400x65	10

PL Miotla
GB Broom
D Strassenbesen
RUS Метла

CZ Metla
RO Matura
H Partvis
E Cepillo pelo largo



No.	L (mm)	
35870	300	10
35872	400	10
35874	500	10
35875	600	10
35876	800	10
35877	1000	10

PL Miotla drucziana do bruku
GB Broom
D Strassenbesen
RUS Метла

CZ Metla
RO Matura
H Partvis
E Cepillo pelo largo



VOREL

No.	L (mm)	
35923	300x55	6
35924	400x55	6

PL Miotla
GB Broom
D Strassenbesen
RUS Метла

CZ Metla
RO Matura
H Partvis
E Cepillo pelo largo



FLO

No.	L (mm)	
35912	1200x22	15



PL Miotla
GB Broom
D Strassenbesen
RUS Метла

CZ Metla
RO Matura
H Partvis
E Cepillo pelo largo



No.	
35869	10

PL Miotla
GB Broom
D Strassenbesen
RUS Метла

CZ Metla
RO Matura
H Partvis
E Cepillo pelo largo



No.	L (mm)	
35914	400x55	10
35915	500x55	10
35916	600x55	10
35918	800x55	10

PL Miotla
GB Broom
D Strassenbesen
RUS Метла

CZ Metla
RO Matura
H Partvis
E Cepillo pelo largo



No.	L (mm)	
35911	1150x22	140

PL Miotla
GB Broom
D Strassenbesen
RUS Метла

CZ Metla
RO Matura
H Partvis
E Cepillo pelo largo



No.	L (mm)	
35893	300	12
35894	400	12
35895	500	12



PL Miotła
GB Broom
D Strassenbesen
RUS Метла

CZ Metla
RO Matura
H Partvis
E Cepillo pelo largo



No.	L (mm)	
35899	250	12

PL Miotła
GB Broom
D Strassenbesen
RUS Метла

CZ Metla
RO Matura
H Partvis
E Cepillo pelo largo



No.	bristle length / dlugosc wlosia (mm)	
35906	135	12

PL Zgarniacz do wody
GB Mop
D Wasserschieber
RUS Сгон для уборки воды

CZ Stěrka s gumou
RO Mop cauciuc
H Vízlehúzó gumi
E Recogedor de agua universal



No.	L (mm)	
04561	330	120
04562	430	12/96

PL Lopata do śniegu
GB Plastic shovel for snow
D Kunststoff-Schneeschaufel
RUS Лопата снеговая

CZ Lopata na sněh
RO Lopată pt. zăpadă
H Műanyag hólapát
E Pala para nieve



No.		
35880		180

PL Miotła
GB Broom
D Strassenbesen
RUS Метла

CZ Metla
RO Matura
H Partvis
E Cepillo pelo largo



No.	bristle length / dlugosc wlosia (mm)	
35905	275	12

PL Miotła
GB Broom
D Strassenbesen
RUS Метла

CZ Metla
RO Matura
H Partvis
E Cepillo pelo largo



No.	bristle length / dlugosc wlosia (mm)	
35908	210	8

PL Wielofunkcyjna podstawa gospodarcza
GB All purpose boot tray
D Garten- & Haushalt-Unterlage
RUS Многофункциональный поднос
CZ Multifunkční podložka
RO Tava multifunctionala
H Többfunkciós tálcá
E Bandeja de arranque universal

780 x 384
x 32 mm



No.	mm	
67260	780x384x32	30

PL Skuwacz do lodu
GB Ice breaker
D Eishammer
RUS Прибор для сковывания льда

CZ Skováč na led
RO Spărgător pt. gheață
H Jégtörő
E Rompehielo mango



No.		
35878		125

PL Worki na gruz, mocne
GB Debris bags
D Müllsäcke stabil
RUS Мешки для щебня

CZ Pytle na suť
RO Saci pt. demolari
H Sittes zsák
E Bolsas para escombros



VOREL

No.	l	pcs / packing	µm	
09475	80	10	142	10
09476	80	3	142	10
09477	120	10	142	10
09478	120	3	142	10

PL Worki na odpady, mocne
GB Waste bags
D Müllbeutel
RUS Пакеты для мусора

CZ Pytle na odpad
RO Saci gunoi
H Szemeteszsák
E Bolsas para desperdicios



VOREL

No.	l	pcs / packing	µm	
09465	120	10	30	25
09466	160	10	40	15
09467	240	10	40	10

PL Worki ogrodowe
GB Garden bags
D Gartensäcke
RUS Мешки для огорода

CZ Zahradní pytle
RO Saci gunoi pt. gradina
H Kertő szemeteszsák
E Bolsas de jardín



FLO

No.	l	pcs / packing	µm	
09481	120	10	60	15

PL Worki perforowane na trawę
GB Waste bags for grass
D Gartenmüllsäcke perforiert
RUS Мусорные пакеты прочные для листьев

CZ Perforované odpadové pytle na trávu
RO Sac gunoi pt. iarba
H Szalagos kertő szemeteszsák
E Sacos perforadas para residuos de jardín



FLO

No.	l	pcs / packing	µm	
09483	120	10	35	25

PL Worki na styropian
GB Waste bags for styrofoam
D Styropor Entsorgungssäcke
RUS Пакеты для мусора строительные материалы

CZ Pytle na polystyren
RO Saci gunoi
H Szemeteszsák
E Sacos de poliestireno



VOREL

No.	l	pcs / packing	µm	
09472	240	10	40	10

PL Worki na odpady, budowlane
GB Construction waste bags
D Müllsäcke
RUS Мешки для строительного мусора

CZ Pytle na stavební odpad
RO Saci gunoi pt. santier
H Zsák építési törmelékhez
E Bolsas para desperdicios de construcción



VOREL

No.	l	pcs / packing	µm	
09470	80	10	40	30
09471	120	15	60	10

PL Worki ogrodowe z taśmą
GB Garden bags with cord
D Gartensäcke mit Band
RUS Мешки для огорода с лентой

CZ Zahradní pytle zatahovací
RO Saci gunoi pt. gradina cu strangere
H Szalagos kertő szemeteszsák
E Bolsas de jardín con cinta



FLO

No.	l	pcs / packing	µm	
09480	60	10	60	12
09482	120	10	60	15

PL Worki perforowane na liście
GB Perforated waste bags for leaves
D Gartenmüllsäcke perforiert
RUS Мусорные пакеты прочные для листьев

CZ Perforované odpadové pytle na listy
RO Szalagos kertő szemeteszsák
H Sac gunoi perforat pt. frunze
E Sacos perforadas para residuos de jardín



FLO

No.	l	pcs / packing	µm	
09484	200	10	40	12

PL Worki na odpady domowe
GB Waste bags
D Müllbeutel
RUS Пакеты для мусора

CZ Pytle na odpad
RO Saci gunoi
H Szemeteszsák
E Bolsas para desperdicios



VOREL

No.	l	pcs packing	µm	material / material	☐
09486	35	50	6	HDPE	40
09487	35	30	11	MDPE	45
09489	60	20	13	MDPE	45

PL Worki na odpady domowe z taśmą
GB Waste bags with cord
D Müllbeutel mit Band
RUS Пакеты для мусора с лентой

CZ Pytle na odpad
RO Saci gunoi
H Szemeteszsák
E Bolsas para desperdicios



VOREL

No.	l	pcs packing	µm	☐
09490	60	10	30	25

PL Worki na odpady z nadrukiem
GB Waste bags
D Müllbeutel
RUS Пакеты для мусора

CZ Pytle na odpad
RO Saci gunoi
H Szemeteszsák
E Bolsas para desperdicios



VOREL

No.	l	pcs / packing	µm	☐
10010	120	10	40	25

PL Worki na odpady z nadrukiem
GB Waste bags
D Müllbeutel
RUS Пакеты для мусора

CZ Pytle na odpad
RO Saci gunoi
H Szemeteszsák
E Bolsas para desperdicios



VOREL

No.	l	pcs / packing	µm	☐
10012	120	10	40	25

PL Worki na odpady super mocne
GB Waste bags super strong
D Müllsäcke extra stark
RUS Пакеты для мусора прочные

CZ Super-silný pytle na odpad
RO Sac gunoi super rezistent
H Szemeteszsák
E Sacos de residuos super fuertes



VOREL

No.	l	pcs packing	µm	☐
09473	35	50	30	10

PL Worki na odpady z uszami, mocne
GB Waste bags strong with holder
D Müllsäcke mit Griff stark
RUS Пакеты для мусора с завязками прочные

CZ Odpadkové pytle s rukojeťi
RO Sac gunoi rezistent cu maner
H Szemeteszsák
E Sacos de desecho fuertes con soporte



VOREL

No.	l	pcs packing	µm	☐
09474	60	20	20	25

PL Worki na odpady z nadrukiem
GB Waste bags
D Müllbeutel
RUS Пакеты для мусора

CZ Pytle na odpad
RO Saci gunoi
H Szemeteszsák
E Bolsas para desperdicios



VOREL

No.	l	pcs / packing	µm	☐
10011	120	10	40	25

PL Worki na odpady z nadrukiem
GB Waste bags
D Müllbeutel
RUS Пакеты для мусора

CZ Pytle na odpad
RO Saci gunoi
H Szemeteszsák
E Bolsas para desperdicios



VOREL

No.	l	pcs / packing	µm	☐
10013	120	10	40	25

PL Worki na odpady z nadrukiem
GB Waste bags
D Müllbeutel
RUS Пакеты для мусора

CZ Pytle na odpad
RO Saci gunoi
H Szemeteszsák
E Bolsas para desperdicios



No.	l	pcs / packing	µm	
10014	120	10	40	25

PL Plandeka
GB Tarpaulin
D Plane
RUS Тент

CZ Plachta
RO Husă
H Ponya
E Toldo

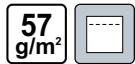

No.	m	g/m2	
85122	2x3	57	30
85123	3x5	57	20
85124	4x5	57	10
85125	4x6	57	8
85126	5x8	57	5
85128	6x10	57	3
85129	8x12	57	2
85130	10x15	57	2

PL Plandeka
GB Tarpaulin
D Plane
RUS Тент

CZ Plachta
RO Husă
H Ponya
E Toldo



No.	m	g/m2	
85020	2x3	90	30
85030	3x5	90	18
85040	4x5	90	9
85050	4x6	90	10
85060	5x8	90	5
85080	6x10	90	4
85090	8x12	90	2
85100	10x15	90	1

PL Worki na odpady z nadrukiem
GB Waste bags
D Müllbeutel
RUS Пакеты для мусора

CZ Pytle na odpad
RO Saci gunoi
H Szemeteszsák
E Bolsas para desperdicios



No.	l	pcs / packing	µm	
10015	120	10	40	25

PL Plandeka
GB Tarpaulin
D Plane
RUS Тент

CZ Plachta
RO Husă
H Ponya
E Toldo

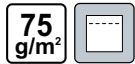

No.	m	g/m2	
85112	2x3	75	30
85113	3x5	75	10
85114	4x5	75	10
85115	4x6	75	8
85116	5x8	75	5
85118	6x10	75	3
85119	8x12	75	2
85120	10x15	75	2

PL Separator do popiołu
GB Ash separator
D Ascheabscheider
RUS Пепелна сепаратор

CZ Odlučovač popela
RO Filtru pt. cenușă
H Hamuporszívó
E Separador de ceniza

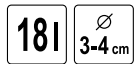

No.	
72920	1

PL Odkurzacz do popiołu
 GB Ash cleaner
 D Aschesauger
 RUS Пылесос для золы
 CZ Vysavač popela
 RO Aspirator pt. cenușa
 H Hamuporszívó
 E Aspirador de cenizas

230V~50Hz 800 W 18l
 14 kPa
 FOR GRILL & FIREPLACE DO GRILLA I KOMINKA
 BLOW FUNCTION FUNKCJA DMUCHAWY
 FIREPROOF HOSE ZAROZOPORNY WAZ



No.	W	
72928	800	1

PL Odkurzacz przemysłowy
 GB Industrial vacuum cleaner
 D Industriesauger
 RUS Пылесос промышленный

CZ Průmyslový vysavač
 RO Aspirator industrial
 H Ipari porszívó
 E Aspirador industria

230V~50Hz 1000 W 20l
 17 kPa IP24
 BLOW FUNCTION FUNKCJA DMUCHAWY
 WET AND DRY SUCHO MOKRO



No.	W	
78871	1000	1

PL Odkurzacz samochodowy
 GB Car vacuum cleaner
 D Handsauger
 RUS Ручной пылесос для автомобиля

CZ Vysavač do auta
 RO Aspirator de masina
 H Autó porszívó
 E Aspirador para coche

12V 100 W
 CYCLONIC CYCLONICZNY
 WET AND DRY SUCHO MOKRO
 BAGLESS BEZWORKOWY



No.	W	V	
82951	100	12	8

PL Odkurzacz do popiołu
 GB Ash cleaner
 D Aschesauger
 RUS Пылесос для золы

CZ Vysavač popela
 RO Aspirator pt. cenușa
 H Hamuporszívó
 E Aspirador de cenizas

230V~50Hz 800 W 20l
 16 kPa
 FOR GRILL & FIREPLACE DO GRILLA I KOMINKA
 BLOW FUNCTION FUNKCJA DMUCHAWY
 FIREPROOF HOSE ZAROZOPORNY WAZ



No.	W	
78870	800	1

PL Odkurzacz przemysłowy
 GB Industrial vacuum cleaner
 D Industriesauger
 RUS Пылесос промышленный

CZ Průmyslový vysavač
 RO Aspirator industrial
 H Ipari porszívó
 E Aspirador industria

230V~50Hz 1600 W 30l
 16 kPa IPX4
 POWER SOCKET GNIAZDO ZASILAJĄCE
 WET AND DRY SUCHO MOKRO
 BLOW FUNCTION FUNKCJA DMUCHAWY



No.	W	
78873	1600	1

PL Filtr z korpusem
GB Pet filter and plastic filter
D Filter mit Gehäuse
RUS Фильтр с корпусом
CZ Filtr s tělesem
RO Filtru cu carcasă
H Szűrő házzal
E Filtro con el armazón



VOREL

No.
72921

64

PL Wąż metalowy
GB Metal hose
D Metallschlauch
RUS Металлический шланг

CZ Kovová hadice
RO Furtun metalic
H Hajlékony, fém tömlő
E Manguera de metal



VOREL

No.
72922

for / dla
72920

20

PL Pompa syfonowa
GB Syphon pump
D Siphon-Pumpe
RUS Сифонный насос

CZ Pumpa syfónová
RO Pompa manuala pt. combustibil
H Többfunkciós szivattyú
E Bomba de sifón



VOREL

No.
78020

30/60

PL Pompa wielofunkcyjna
GB Multi-purpose pump
D Multifunktionale Pumpe
RUS Многофункциональный насос

CZ Univerzální pumpička
RO Pompă multifuncțională
H Többfunkciós szivattyú
E Bomba multiusos



VOREL

No.
78022

6/24

PL Filtr
GB Filter
D Filter
RUS Фильтр

CZ Filtr
RO Filtru
H Szűrő
E Filtro

FOR/DLA
72930



VOREL

No.
72931

for / dla
72930; 78870

24

PL Wąż metalowy
GB Metal hose
D Metallschlauch
RUS Металлический шланг

CZ Kovová hadice
RO Furtun metalic
H Hajlékony, fém tömlő
E Manguera de metal

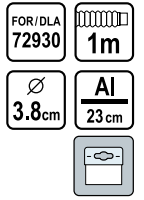

VOREL

No.
72932

for / dla
72930

24

PL Pompa syfonowa
GB Syphon pump
D Siphon-Pumpe
RUS Сифонный насос

CZ Pumpa syfónová
RO Pompa manuala pt. combustibil
H Szifon pumpa
E Bomba de sifón



VOREL

No.
78021

24

PL Pistolet do udrażniania rur
GB Drain cleaner
D Pistole zum Reinigen von Rohren
RUS Пистолет для прочистки труб

CZ Pistole na čištění trubek
RO Pistol pt. curățarea țevilor
H Csőtisztító pisztoly
E Pistola destapacaños



VOREL

No.
55500

Ø (mm)
135

10



- PL Pompa do udrażniania kanalizacji
 GB Drain suction pump
 D Hochdruck-Rohrreiner
 RUS Ручной насос для прочистки труб
- CZ Čerpadlo na čištění trubek
 RO Pompă pt. curățarea tevilor
 H Csőtisztító szivattyú
 E El desagüe del fregadero limpiador



No.	Ø (mm)	Icon
55505	65; 155	24

- PL Spirala kanalizacyjna
 GB Drain auger
 D Hand-Rohrreinigungsspirale
 RUS Трос сантехнический пружинный
- CZ Spirála kanalizační
 RO Dispozitiv de desfundat scurgere
 H Csőtisztító spirál
 E Desatascador espiral



No.	Ø (mm)	L (m)	Icon
55541	5	1.5	20/80
55542	6	3	18/36

- PL Wazelina techniczna
 GB Vaseline
 D Vaseline
 RUS Вазелин технический
- CZ Technická vazelína
 RO Vaselină tehnică
 H Műszaki vazelin
 E Vaselina tecnica



No.	ml	Icon
86700	50	50
86701	100	50

- PL Przepychacz do udrażniania kanalizacji
 GB Pipe cleaner
 D Räumdorn zum Reinigen der Kanalisation
 RUS Поршень для прочистки канализации
- CZ Tlakový čistič kanalizace
 RO Piston pt. deblocarea canalizării
 H Lefolyótisztító pumpa
 E Bomba destaparcaños



No.	L (cm)	pcs	Icon
55531	65	2	36

- PL Spirala kanalizacyjna
 GB Drain auger
 D Hand-Rohrreinigungsspirale
 RUS Трос сантехнический пружинный
- CZ Spirála kanalizační
 RO Dispozitiv de desfundat scurgere
 H Csőtisztító spirál
 E Desatascador espiral



No.	Ø (mm)	L (m)	Icon
55544	9	5	5/10
55545	9	10	4/8

- PL Wózek transportowy poziomy
 GB Cargo pilot
 D Transportwagen Klappbar
 RUS Тележка с платформой
- CZ Vozík skladový
 RO Carut pt. gabarit
 H Rakodó kocsi
 E Carretilla de carga



No.	max. capacity / max. ładowność (kg)	Icon
87600	150	1

- PL Składany wózek magazynowy
- GB Foldable hand truck
- D Klappbare Transportkarre
- RUS Складная тележка
- CZ Skladací hliníkový rudi
- RO Carucior cu manere pliable
- H Összecsukható kézikocsi
- E Carretilla de mano plegable



No.	max. capacity / max. ładowność (kg)	
78660	60	1

- PL Kółko stałe
- GB Fixed caster
- D Bockrolle
- RUS Ролик с стационарной опорой
- CZ Pevné kolečko
- RO Roata de carucior fixa
- H Szállítógörgök
- E Rueda fija

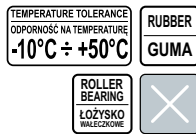

No.	wheel diameter / średnica kółka (mm)	wheel width / szerokość kółka (mm)	caster height / wysokość kółka (mm)	load capacity / obciążalność (kg)	
87301	75	23	97	40	60
87302	100	27	130	60	32
87303	125	34	155	100	22
87305	160	40	195	130	10
87307	200	46	235	150	8

- PL Kółko skrętne z czarną gumą
- GB Swivel caster
- D Lenkrolle mit Feststeller
- RUS Ролик с вращающейся опорой
- CZ Otočné kolečko
- RO Roata de carucior mobila
- H Szállítógörgök
- E Rueda giratoria con freno

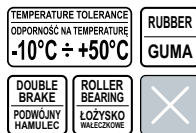

No.	wheel diameter / średnica kółka (mm)	wheel width / szerokość kółka (mm)	caster height / wysokość kółka (mm)	load capacity / obciążalność (kg)	
87321	75	23	97	40	40
87322	100	27	130	60	20
87323	125	34	155	100	16
87325	160	40	195	130	8
87327	200	46	235	150	6

- PL Składany wózek magazynowy
- GB Foldable hand truck
- D Klappbare Transportkarre
- RUS Складная тележка
- CZ Skladací hliníkový rudi
- RO Carucior cu manere pliable
- H Összecsukható kézikocsi
- E Carretilla de mano plegable

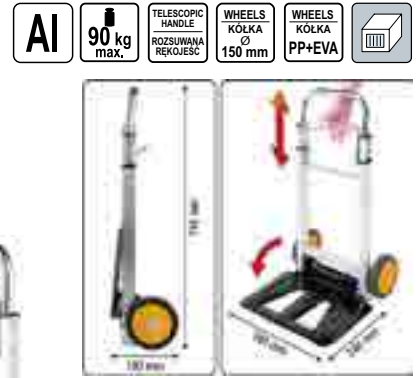

No.	max. capacity / max. ładowność (kg)	
78661	90	1

- PL Kółko skrętne z czarną gumą
- GB Swivel caster
- D Lenkrolle mit Feststeller
- RUS Ролик с вращающейся опорой
- CZ Otočné kolečko
- RO Roata de carucior mobila
- H Szállítógörgök
- E Rueda giratoria con freno

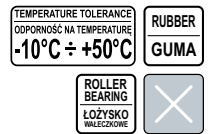

No.	wheel diameter / średnica kółka (mm)	wheel width / szerokość kółka (mm)	caster height / wysokość kółka (mm)	load capacity / obciążalność (kg)	
87311	75	23	97	40	48
87312	100	27	130	60	26
87313	125	34	155	100	20
87315	160	40	195	130	10
87317	200	46	235	150	6

- PL Kółko skrętne z czarną gumą
- GB Swivel caster
- D Lenkrolle mit Feststeller
- RUS Ролик с вращающейся опорой
- CZ Otočné kolečko
- RO Roata de carucior mobila
- H Szállítógörgök
- E Rueda giratoria con freno

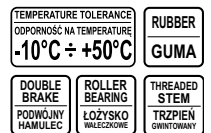

No.	wheel diameter / średnica kółka (mm)	wheel width / szerokość kółka (mm)	caster height / wysokość kółka (mm)	load capacity / obciążalność (kg)	
87331	75	22	97	40	38
87332	100	26	130	60	24
87333	125	33	153	100	18
87335	160	39	190	130	8
87337	200	44	230	150	6

- PL Kółko skrętne z szarą gumą
- GB Swivel caster
- D Lenkrolle mit Feststeller
- RUS Ролик с вращающийся опорой
- CZ Otočné kolečko
- RO Roata de carucior mobila
- H Szállítógörgők
- E Rueda giratoria con freno

TEMPERATURE TOLERANCE
ODPORNOŚĆ NA TEMPERATURĘ
-10°C ÷ +50°C

RUBBER
GUMA

PLAIN BEARING
ŁOŻYSKO ŚLIZGOWE



VOREL

No.	wheel diameter / średnica kółka (mm)	wheel width / szerokość kółka (mm)	caster height / wysokość kółka (mm)	load capacity / obciążalność (kg)	
87351	50	16	72	20	140
87352	75	21	104	30	60
87353	100	26	134	45	38
87354	125	27	161	50	25

- PL Kółko skrętne z szarą gumą
- GB Swivel caster
- D Lenkrolle mit Feststeller
- RUS Ролик с вращающийся опорой
- CZ Otočné kolečko
- RO Roata de carucior mobila
- H Szállítógörgők
- E Rueda giratoria con freno

TEMPERATURE TOLERANCE
ODPORNOŚĆ NA TEMPERATURĘ
-10°C ÷ +50°C

RUBBER
GUMA

BOLT HOLE
OTWÓR MOCUJĄCY

PLAIN BEARING
ŁOŻYSKO ŚLIZGOWE



VOREL

No.	wheel diameter / średnica kółka (mm)	wheel width / szerokość kółka (mm)	caster height / wysokość kółka (mm)	load capacity / obciążalność (kg)	
87371	50	16	70	20	120
87372	75	21	101	30	64
87373	100	26	132	45	34
87374	125	27	158	50	24

- PL Kółko stałe
- GB Fixed caster
- D Bockrolle
- RUS Ролик с стационарной опорой
- CZ Pevné kolečko
- RO Roata de carucior fixa
- H Szállítógörgők
- E Rueda fija

TEMPERATURE TOLERANCE
ODPORNOŚĆ NA TEMPERATURĘ
-10°C ÷ +50°C

POLYPROPYLENE
POLIPROPYLEN

POM BEARING
ŁOŻYSKO POM



VOREL

No.	wheel diameter / średnica kółka (mm)	wheel width / szerokość kółka (mm)	caster height / wysokość kółka (mm)	load capacity / obciążalność (kg)	
87391	40	17	54	20	280
87392	50	22	65	25	130
87393	65	23	84	30	90

- PL Kółko skrętne z szarą gumą
- GB Swivel caster
- D Lenkrolle mit Feststeller
- RUS Ролик с вращающийся опорой
- CZ Otočné kolečko
- RO Roata de carucior mobila
- H Szállítógörgők
- E Rueda giratoria con freno

TEMPERATURE TOLERANCE
ODPORNOŚĆ NA TEMPERATURĘ
-10°C ÷ +50°C

RUBBER
GUMA

PLAIN BEARING
ŁOŻYSKO ŚLIZGOWE



VOREL

No.	wheel diameter / średnica kółka (mm)	wheel width / szerokość kółka (mm)	caster height / wysokość kółka (mm)	load capacity / obciążalność (kg)	
87361	50	16	72	20	100
87362	75	21	104	30	52
87363	100	26	134	45	28
87364	125	27	161	50	24

- PL Kółko skrętne z szarą gumą
- GB Swivel caster
- D Lenkrolle mit Feststeller
- RUS Ролик с вращающийся опорой
- CZ Otočné kolečko
- RO Roata de carucior mobila
- H Szállítógörgők
- E Rueda giratoria con freno

TEMPERATURE TOLERANCE
ODPORNOŚĆ NA TEMPERATURĘ
-10°C ÷ +50°C

RUBBER
GUMA

BRAKE
HAMULEC

PLAIN BEARING
ŁOŻYSKO ŚLIZGOWE



VOREL

No.	wheel diameter / średnica kółka (mm)	wheel width / szerokość kółka (mm)	caster height / wysokość kółka (mm)	load capacity / obciążalność (kg)	
87381	50	16	72	20	96
87382	75	21	104	30	50
87383	100	26	134	45	26
87384	125	27	161	50	22

- PL Kółko skrętne
- GB Swivel caster
- D Lenkrolle mit Feststeller
- RUS Ролик с вращающийся опорой
- CZ Otočné kolečko
- RO Roata de carucior mobila
- H Szállítógörgők
- E Rueda giratoria con freno

TEMPERATURE TOLERANCE
ODPORNOŚĆ NA TEMPERATURĘ
-10°C ÷ +50°C

POLYPROPYLENE
POLIPROPYLEN

POM BEARING
ŁOŻYSKO POM



VOREL

No.	wheel diameter / średnica kółka (mm)	wheel width / szerokość kółka (mm)	caster height / wysokość kółka (mm)	load capacity / obciążalność (kg)	
87401	40	17	54	20	260
87402	50	22	65	25	120
87403	65	23	84	30	78

- PL Kółko skrętne
GB Swivel caster
D Lenkrolle mit Feststeller
RUS Ролик с вращающейся опорой
- CZ Otočné kolečko
RO Roata de carucior mobila
H Szállítógörgők
E Rueda giratoria con freno

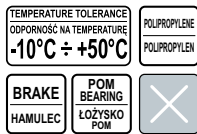

No.	wheel diameter / średnica kółka (mm)	wheel width / szerokość kółka (mm)	caster height / wysokość kółka (mm)	load capacity / obciążalność (kg)	
87411	40	17	54	20	230
87412	50	22	65	25	110
87413	65	23	84	30	72

- PL Kółko skrętne
GB Swivel caster
D Lenkrolle mit Feststeller
RUS Ролик с вращающейся опорой
- CZ Otočné kolečko
RO Roata de carucior mobila
H Szállítógörgők
E Rueda giratoria con freno

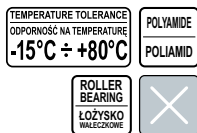

No.	wheel diameter / średnica kółka (mm)	wheel width / szerokość kółka (mm)	caster height / wysokość kółka (mm)	load capacity / obciążalność (kg)	
87431	75	23	97	40	60
87432	100	31	130	60	32
87433	125	33	155	100	26
87435	160	40	195	130	12
87437	200	40	235	150	8

- PL Uszczelka do okien i drzwi
GB Seal for windows and doors
D Dichtung für Fenster und Türen
RUS Уплотнители для окон и дверей

- CZ Těsnění oken a dveří
RO Seal pt. ferestre si usi
H Seal az ablakok és ajtók
E Sellar para ventanas y puertas



3.0 - 7.0 mm



No.	dimensions / wymiary (mm)	L (m)	type / profil	colour / kolor	
76752	9x7.4	6	D		24
76762	9x7.4	6	D		24

- PL Kółko stale
GB Fixed caster
D Bockrolle
RUS Ролик с стационарной опорой
CZ Pevné kolečko
RO Roata de carucior fixa
H Szállítógörgők
E Rueda fija

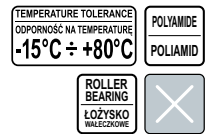

No.	wheel diameter / średnica kółka (mm)	wheel width / szerokość kółka (mm)	caster height / wysokość kółka (mm)	load capacity / obciążalność (kg)	
87422	100	31	130	60	38
87423	125	33	155	100	28
87425	160	40	195	130	12
87427	200	40	235	150	8

- PL Kółko czarna guma
GB Wheel
D Transportrad
RUS Ролик
- CZ Kolečko
RO Roata de carucior
H Önálló görgők
E Rueda

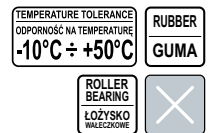

No.	wheel diameter / średnica kółka (mm)	wheel width / szerokość kółka (mm)	axle / oś	load capacity / obciążalność (kg)	
87451	75	22	Ø12mm x 30mm	40	150
87452	100	26	Ø12mm x 40mm	60	66
87453	125	33	Ø15mm x 40mm	100	36
87454	150	39	Ø20mm x 55mm	110	22
87455	160	39	Ø20mm x 55mm	130	20
87456	200	44	Ø20/25mm x 55mm	150	12
87457	250	48	Ø20/25mm x 55mm	180	8

- PL Uszczelka do okien i drzwi
GB Seal for windows and doors
D Dichtung für Fenster und Türen
RUS Уплотнители для окон и дверей

- CZ Těsnění oken a dveří
RO Seal pt. ferestre si usi
H Seal az ablakok és ajtók
E Sellar para ventanas y puertas



3.0 - 7.0 mm

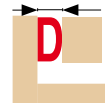

No.	dimensions / wymiary (mm)	L (m)	type / profil	colour / kolor	
76757	9x7.4	100	D		6
76767	9x7.4	100	D		6

PL Uszczelka do okien i drzwi
 GB Seal for windows and doors
 D Dichtung für Fenster und Türen
 RUS Уплотнители для окон и дверей

CZ Těsnění oken a dveří
 RO Seal pt. ferestre si usi
 H Seal az ablakok és ajtók
 E Sellar para ventanas y puertas



2.0 - 3.5 mm

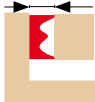

No.	dimensions / wymary (mm)	L (m)	type / profil	colour / kolor	☐
76750	9x4	6	E	○	24
76760	9x4	6	E	●	24

PL Uszczelka do okien i drzwi
 GB Seal for windows and doors
 D Dichtung für Fenster und Türen
 RUS Уплотнители для окон и дверей

CZ Těsnění oken a dveří
 RO Seal pt. ferestre si usi
 H Seal az ablakok és ajtók
 E Sellar para ventanas y puertas



3.0 - 5.0 mm



No.	dimensions / wymary (mm)	L (m)	type / profil	colour / kolor	☐
76751	9x5.5	6	P	○	24
76761	9x5.5	6	P	●	24

PL Podkładka samoprzylepna, korkowa
 GB Self-adhesive pad for furniture
 D Klebegleiter für Möbel
 RUS Самоклеящая подкладка под мебель

CZ Podložka samolepící pod nábytek
 RO Adeziv pad sub mobilier
 H Öntapadó, bútörfáb alátét
 E Arandela adhesiva bajo los muebles



No.	Ø (mm)	pcs	☐
74802	20	20	60/720
74804	28	12	60/720

PL Uszczelka do okien i drzwi
 GB Seal for windows and doors
 D Dichtung für Fenster und Türen
 RUS Уплотнители для окон и дверей

CZ Těsnění oken a dveří
 RO Seal pt. ferestre si usi
 H Seal az ablakok és ajtók
 E Sellar para ventanas y puertas



2.0 - 3.5 mm



No.	dimensions / wymary (mm)	L (m)	type / profil	colour / kolor	☐
76755	9x4	150	E	○	6
76765	9x4	150	E	●	6

PL Uszczelka do okien i drzwi
 GB Seal for windows and doors
 D Dichtung für Fenster und Türen
 RUS Уплотнители для окон и дверей

CZ Těsnění oken a dveří
 RO Seal pt. ferestre si usi
 H Seal az ablakok és ajtók
 E Sellar para ventanas y puertas



3.0 - 5.0 mm



No.	dimensions / wymary (mm)	L (m)	type / profil	colour / kolor	☐
76756	9x5.5	100	P	○	6
76766	9x5.5	100	P	●	6

PL Podkładka samoprzylepna, korkowa
 GB Self-adhesive pad for furniture
 D Klebegleiter für Möbel
 RUS Самоклеящая подкладка под мебель

CZ Podložka samolepící pod nábytek
 RO Adeziv pad sub mobilier
 H Öntapadó, bútörfáb alátét
 E Arandela adhesiva bajo los muebles



No.	mm	pcs	☐
74812	100x120	1	60/720

- PL Podkładka samoprzylepna, antypoślizgowa
 GB Self-adhesive pad for furniture
 D Klebegleiter für Möbel
 RUS Самоклеящая подкладка под мебель
- CZ Podložka samolepící pod nábytek
 RO Adeziv pad sub mobilier
 H Őntapadó, bútorláb alátét
 E Arandela adhesiva bajo los muebles

NON-SLIP
ANTI-POŚLIZGOWY

VOREL

No.	Ø (mm)	pcs	
74816	10	24	60/720
74818	20	20	60/720
74820	28	12	60/720

- PL Podkładka samoprzylepna z włókniny
 GB Self-adhesive pad for furniture
 D Klebegleiter für Möbel
 RUS Самоклеящая подкладка под мебель
- CZ Podložka samolepící pod nábytek
 RO Adeziv pad sub mobilier
 H Őntapadó, bútorláb alátét
 E Arandela adhesiva bajo los muebles

NONWOVEN
WŁÓKNINA

VOREL

No.	Ø (mm)	pcs	
74831	20	20	60/720
74833	28	12	60/720
74835	40	4	60/720

- PL Podkładka samoprzylepna z włókniny
 GB Self-adhesive pad for furniture
 D Klebegleiter für Möbel
 RUS Самоклеящая подкладка под мебель
- CZ Podložka samolepící pod nábytek
 RO Adeziv pad sub mobilier
 H Őntapadó, bútorláb alátét
 E Arandela adhesiva bajo los muebles

NONWOVEN
WŁÓKNINA

VOREL

No.	mm	pcs	
74841	20x20	20	60/720
74843	28x28	12	60/720

- PL Podkładka samoprzylepna z włókniny
 GB Self-adhesive pad for furniture
 D Klebegleiter für Möbel
 RUS Самоклеящая подкладка под мебель
- CZ Podložka samolepící pod nábytek
 RO Adeziv pad sub mobilier
 H Őntapadó, bútorláb alátét
 E Arandela adhesiva bajo los muebles

NONWOVEN
WŁÓKNINA

VOREL

No.	mm	pcs	
74849	100x120	1	60/720

- PL Podkładka samoprzylepna, antypoślizgowa
 GB Self-adhesive pad for furniture
 D Klebegleiter für Möbel
 RUS Самоклеящая подкладка под мебель
- CZ Podložka samolepící pod nábytek
 RO Adeziv pad sub mobilier
 H Őntapadó, bútorláb alátét
 E Arandela adhesiva bajo los muebles

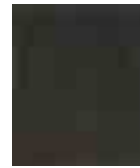
NON-SLIP
ANTI-POŚLIZGOWY

VOREL

No.	mm	pcs	
74828	100x120	1	60/720

- PL Podkładka samoprzylepna z włókniny mix
 GB Self-adhesive pad for furniture
 D Klebegleiter für Möbel
 RUS Самоклеящая подкладка под мебель
- CZ Podložka samolepící pod nábytek
 RO Adeziv pad sub mobilier
 H Őntapadó, bútorláb alátét
 E Arandela adhesiva bajo los muebles

NONWOVEN
WŁÓKNINA

MIX



VOREL

No.	Ø (mm)	pcs	
74838	20; 38	12	60/720

- PL Podkładka samoprzylepna z włókniny
 GB Self-adhesive pad for furniture
 D Klebegleiter für Möbel
 RUS Самоклеящая подкладка под мебель
- CZ Podložka samolepící pod nábytek
 RO Adeziv pad sub mobilier
 H Őntapadó, bútorláb alátét
 E Arandela adhesiva bajo los muebles

NONWOVEN
WŁÓKNINA

VOREL

No.	mm	pcs	
74846	20x45	10	60/720

- PL Podkładka samoprzylepna z włókniny mix
 GB Self-adhesive pad for furniture
 D Klebegleiter für Möbel
 RUS Самоклеящая подкладка под мебель
- CZ Podložka samolepící pod nábytek
 RO Adeziv pad sub mobilier
 H Őntapadó, bútorláb alátét
 E Arandela adhesiva bajo los muebles

NONWOVEN
WŁÓKNINA

MIX



VOREL

No.	Ø (mm)	pcs	
74858	20; 38	12	60/720

PL Podkładka samoprzylepna z włókniny
 GB Self-adhesive pad for furniture
 D Klebegleiter für Möbel
 RUS Самоклеящая подкладка под мебель

CZ Podložka samolepicí pod nábytek
 RO Adeziv pad sub mobilier
 H Őntapadó, bútorláb alátét
 E Arandela adhesiva bajo los muebles

NONWOVEN
 WŁÓKNINA



No.	mm	pcs	
74861	20x20	20	60/720
74863	28x28	12	60/720

PL Podkładka samoprzylepna z włókniny
 GB Self-adhesive pad for furniture
 D Klebegleiter für Möbel
 RUS Самоклеящая подкладка под мебель

CZ Podložka samolepicí pod nábytek
 RO Adeziv pad sub mobilier
 H Őntapadó, bútorláb alátét
 E Arandela adhesiva bajo los muebles

NONWOVEN
 WŁÓKNINA



No.	mm	pcs	
74866	20x45	10	60/720

PL Podkładka samoprzylepna, antypoślizgowa
 GB Self-adhesive pad for furniture
 D Klebegleiter für Möbel
 RUS Самоклеящая подкладка под мебель

CZ Podložka samolepicí pod nábytek
 RO Adeziv pad sub mobilier
 H Őntapadó, bútorláb alátét
 E Arandela adhesiva bajo los muebles

NON-SLIP
 ANTY-
 POŚLIZGOWY



No.	Ø (mm)	pcs	
74882	25	18	24/432
74883	38	8	24/432

PL Podkładka samoprzylepna, silikonowa
 GB Self-adhesive silicone pad for furniture
 D Klebegleiter für Möbel
 RUS Самоклеящая подкладка под мебель

CZ Podložka samolepicí pod nábytek
 RO Adeziv pad sub mobilier
 H Őntapadó, bútorláb alátét
 E Arandela adhesiva bajo los muebles

SILICONE
 SILIKON



No.	Ø (mm)	pcs	
74910	8	25	32/576
74911	10	20	32/576
74912	13	12	32/576
74913	15	9	32/576
74914	19	6	32/576



No.	Ø (mm)	pcs	
74851	20	20	60/720
74853	28	12	60/720
74855	40	4	60/720
74856	50	2	60/720

PL Podkładka samoprzylepna z włókniny
 GB Self-adhesive pad for furniture
 D Klebegleiter für Möbel
 RUS Самоклеящая подкладка под мебель

CZ Podložka samolepicí pod nábytek
 RO Adeziv pad sub mobilier
 H Őntapadó, bútorláb alátét
 E Arandela adhesiva bajo los muebles

NONWOVEN
 WŁÓKNINA



No.	mm	pcs	
74869	100x120	1	60/720

PL Podkładka samoprzylepna, antypoślizgowa
 GB Self-adhesive pad for furniture
 D Klebegleiter für Möbel
 RUS Самоклеящая подкладка под мебель

CZ Podložka samolepicí pod nábytek
 RO Adeziv pad sub mobilier
 H Őntapadó, bútorláb alátét
 E Arandela adhesiva bajo los muebles

NON-SLIP
 ANTY-
 POŚLIZGOWY



No.	Ø (mm)	pcs	
74885	18	32	24/432
74886	25	18	24/432
74887	38	8	24/432

- PL Podkładki plastikowo-filcowe na gwóźdź
 GB Felt & plastic furniture glides
 D Kunststoff- und Filzgleiter zum Nageln
 RUS Подкладки пластиковые фелцевые на гвоздь
 CZ Plastové podložky s plstí na hřebík
 RO Şaibe din plastic-pâslă pt. cuie
 H Műanyag-filc alátét szőghöz
 E Arandelas de plástico y fieltro con clave



No.	Ø (mm)	pcs	
74920	17	16	16/288
74921	20	12	16/288
74922	24	12	16/288
74923	28	8	16/256
74924	30	8	16/256

- PL Klíny pod meble
 GB Levelling wedge
 D Keile für Möbel
 RUS Клинья под мебель
 CZ Klíny pod nábytek
 RO Pene pt. mobilă
 H Bútorék
 E Cuña para muebles



No.	pcs	
74960	4	16/288

- PL Stolek plastikowy
 GB Plastic stool
 D Kunststoff Hocker
 RUS Пластиковый табурет
 CZ Plastová stolička
 RO Scaun de plastic
 H Műanyag széklét
 E Taburete de plástico



No.	size / rozmiar (cm)	
75916	30x20x21	10/20

- PL Podkładki plastikowe na gwóźdź
 GB Plastic furniture glides
 D Kunststoffgleiter zum Nageln
 RUS Подкладки пластиковые на гвоздь

- CZ Plastové podložky na hřebík
 RO Şaibe din plastic pt. cuie
 H Műanyag alátét szőghöz
 E Arandelas de plástico con clave

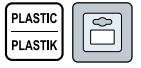

No.	Ø (mm)	pcs	
74935	18	12	16/288
74936	20	12	16/288

- PL Stolek plastikowy
 GB Plastic stool
 D Kunststoff Hocker
 RUS Пластиковый табурет
 CZ Plastová stolička
 RO Scaun de plastic
 H Műanyag széklét
 E Taburete de plástico



No.	size / rozmiar (cm)	
75915	30x20x21	10/20

- PL Haczyki naścienne samoprzylepne
 GB Self-adhesive hanging hooks
 D Selbstklebende Wandhaken
 RUS Крючки настенные на липучках

- CZ Háčky nástěnné samolepící
 RO Cârligie perete autocolante
 H Műanyag, fali kampó, öntapadós
 E Ganchos adhesivos para pared



No.	max (kg)	pcs	
74730	1.0	3	12/144

PL Haczyki naścienne samoprzylepne
 GB Self-adhesive hanging hooks
 D Selbstklebende Wandhaken
 RUS Крючки настенные на липучках
 CZ Háčky nástěnné samolepící
 RO Cârîlige perete autocolante
 H Műanyag, fali kampó, öntapadós
 E Ganchos adhesivos para pared



No.	max (kg)	pcs	
74732	1.0	3	12/192

PL Haczyki naścienne samoprzylepne
 GB Self-adhesive hanging hooks
 D Selbstklebende Wandhaken
 RUS Крючки настенные на липучках

CZ Háčky nástěnné samolepící
 RO Cârîlige perete autocolante
 H Műanyag, fali kampó, öntapadós
 E Ganchos adhesivos para pared



No.	max (kg)	pcs	
74733	0.8	4	12/192

PL Haczyki naścienne samoprzylepne
 GB Self-adhesive hanging hooks
 D Selbstklebende Wandhaken
 RUS Крючки настенные на липучках

CZ Háčky nástěnné samolepící
 RO Cârîlige perete autocolante
 H Műanyag, fali kampó, öntapadós
 E Ganchos adhesivos para pared

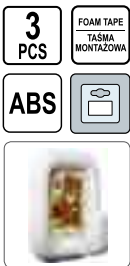

No.	max (kg)	pcs	
74740	0.6	3	12/216

PL Haczyki naścienne samoprzylepne
 GB Self-adhesive hanging hooks
 D Selbstklebende Wandhaken
 RUS Крючки настенные на липучках

CZ Háčky nástěnné samolepící
 RO Cârîlige perete autocolante
 H Műanyag, fali kampó, öntapadós
 E Ganchos adhesivos para pared

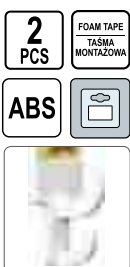

No.	max (kg)	pcs	
74742	1.2	2	8/144

PL Haczyki naścienne samoprzylepne
 GB Self-adhesive hanging hooks
 D Selbstklebende Wandhaken
 RUS Крючки настенные на липучках
 CZ Háčky nástěnné samolepící
 RO Cârîlige perete autocolante
 H Műanyag, fali kampó, öntapadós
 E Ganchos adhesivos para pared



No.	max (kg)	pcs	
74731	0.8	3	12/216

PL Haczyki naścienne samoprzylepne
 GB Self-adhesive hanging hooks
 D Selbstklebende Wandhaken
 RUS Крючки настенные на липучках
 CZ Háčky nástěnné samolepící
 RO Cârîlige perete autocolante
 H Műanyag, fali kampó, öntapadós
 E Ganchos adhesivos para pared



No.	max (kg)	pcs	
74734	0.4	6	16/192

PL Haczyki naścienne samoprzylepne
 GB Self-adhesive hanging hooks
 D Selbstklebende Wandhaken
 RUS Крючки настенные на липучках

CZ Háčky nástěnné samolepící
 RO Cârîlige perete autocolante
 H Műanyag, fali kampó, öntapadós
 E Ganchos adhesivos para pared

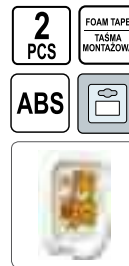

No.	max (kg)	pcs	
74741	1.5	2	12/216

PL Haczyki naścienne samoprzylepne
 GB Self-adhesive hanging hooks
 D Selbstklebende Wandhaken
 RUS Крючки настенные на липучках

CZ Háčky nástěnné samolepící
 RO Cârîlige perete autocolante
 H Műanyag, fali kampó, öntapadós
 E Ganchos adhesivos para pared

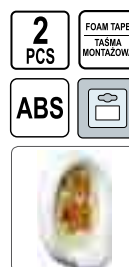

No.	max (kg)	pcs	
74743	1.0	2	12/144

PL Haczyki naścienne samoprzylepne
GB Self-adhesive hanging hooks
D Selbstklebende Wandhaken
RUS Крючки настенные на липучках

CZ Háčky nástěnné samolepící
RO Cărlige perete autocolante
H Műanyag, fali kampó, öntapadós
E Ganchos adhesivos para pared



No.	max (kg)	pcs	
74744	1.0	2	8/144

PL Haczyki naścienne samoprzylepne
GB Self-adhesive hanging hooks
D Selbstklebende Wandhaken
RUS Крючки настенные на липучках
CZ Háčky nástěnné samolepící
RO Cărlige perete autocolante
H Műanyag, fali kampó, öntapadós
E Ganchos adhesivos para pared

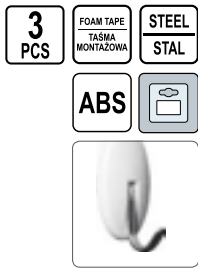

No.	max (kg)	pcs	
74751	0.8	3	16/192

PL Haczyki naścienne samoprzylepne
GB Self-adhesive hanging hooks
D Selbstklebende Wandhaken
RUS Крючки настенные на липучках
CZ Háčky nástěnné samolepící
RO Cărlige perete autocolante
H Műanyag, fali kampó, öntapadós
E Ganchos adhesivos para pared

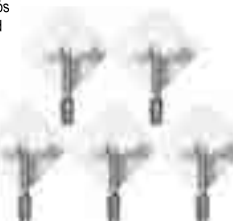
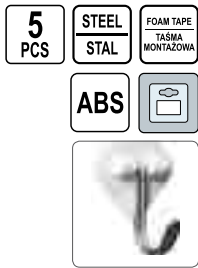

No.	max (kg)	pcs	
74753	0.4	5	16/288

PL Haczyki naścienne szpilkowe
GB Wall hooks with pins
D Wandhaken, mit Nadeln
RUS Крючки настенные шпильковые
CZ Háčky do panelu Twenty
RO Cărlige perete cu bolturi
H Műanyag, fali kampó, körmös
E Ganchos de afililer para pared

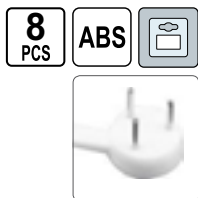

No.	max (kg)	pcs	
74760	3.0	8	24/288

PL Haczyki naścienne samoprzylepne
GB Self-adhesive hanging hooks
D Selbstklebende Wandhaken
RUS Крючки настенные на липучках
CZ Háčky nástěnné samolepící
RO Cărlige perete autocolante
H Műanyag, fali kampó, öntapadós
E Ganchos adhesivos para pared

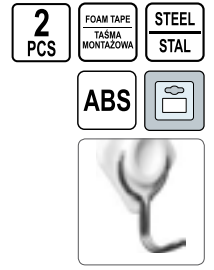

No.	max (kg)	pcs	
74750	1.0	2	16/192

PL Haczyki naścienne samoprzylepne
GB Self-adhesive hanging hooks
D Selbstklebende Wandhaken
RUS Крючки настенные на липучках
CZ Háčky nástěnné samolepící
RO Cărlige perete autocolante
H Műanyag, fali kampó, öntapadós
E Ganchos adhesivos para pared

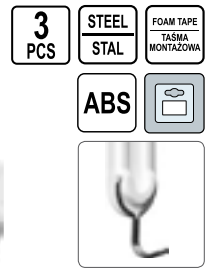

No.	max (kg)	pcs	
74752	1.2	3	18/216

PL Haczyki naścienne samoprzylepne
GB Self-adhesive hanging hooks
D Selbstklebende Wandhaken
RUS Крючки настенные на липучках
CZ Háčky nástěnné samolepící
RO Cărlige perete autocolante
H Műanyag, fali kampó, öntapadós
E Ganchos adhesivos para pared

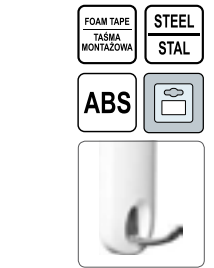

No.	max (kg)	pcs	
74754	4.5	1	8/128

PL Haczyki naścienne na wkręt
GB Wall hooks with screws
D Wandhaken zum Anschrauben
RUS Крючки настенные на шурупах

CZ Háčky nástěnné na šroub
RO Cărlige perete cu surub
H Műanyag, fali kampó, csavaros
E Ganchos atornillados para pared

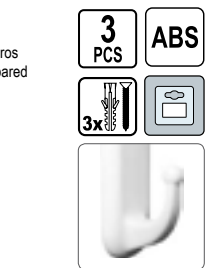

No.	max (kg)	pcs	
74765	5.0	3	16/256

- PL Haczyki naścienne na wkręt
 GB Wall hooks with screws
 D Wandhaken zum Anschrauben
 RUS Крючки настенные на шурупах
 CZ Háčky nástěnné na šroub
 RO Cârlige perete cu șurub
 H Műanyag, fali kampó, csavaros
 E Ganchos atornillados para pared



No.	max (kg)	pcs	
74766	8.0	3	12/192

- PL Ochraniacze na narożniki meblowe
 GB Corner cushions
 D Eckenschoner für Möbel
 RUS Насадки на углы мебели
- CZ Chráníče na rohy nábytku
 RO Protecție colțuri mobilă
 H Bútor sarokvédő
 E Protectores esquineros para muebles



No.	pcs	
74772	4	16/288

- PL Zabezpieczenie otwarcia drzwi meblowych
 GB Multi-purpose latches
 D Schutzsicherung gegen das Öffnen der Möbeltüren
 RUS Блокатор открывания дверей мебели
 CZ Pojistka proti otevření nábytkových dveří
 RO Protecție deschidere uși mobilă
 H Bútorajtó-ütököző
 E Protectores para las portezuelas de muebles para prevenir su apertura



No.	pcs	
74775	2	16/256

- PL Zabezpieczenie odkręcania kurków kuchennych
 GB Oven knob covers
 D Schutz gegen das Abdrehen von Küchenhähnen
 RUS Блокатор открывания кухонных кранов
 CZ Pojistka proti otevření kuchyňských kohoutků
 RO Protecție desfacere mâneră bucatărie
 H Gáztűzhely csapjának kinyitása ellen védő sapka
 E Protectores para las llaves de cocina para prevenir su apertura



No.	pcs	
74777	2	8/96

- PL Ochraniacze na narożniki meblowe
 GB Corner cushions
 D Eckenschoner für Möbel
 RUS Насадки на углы мебели
- CZ Chráníče na rohy nábytku
 RO Protecție colțuri mobilă
 H Bútor sarokvédő
 E Protectores esquineros para muebles



No.	pcs	
74771	4	16/288

- PL Ochraniacze na narożniki meblowe
 GB Corner cushions
 D Eckenschoner für Möbel
 RUS Насадки на углы мебели
- CZ Chráníče na rohy nábytku
 RO Protecție colțuri mobilă
 H Bútor sarokvédő
 E Protectores esquineros para muebles

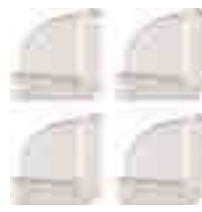

No.	pcs	
74773	4	12/144

- PL Zabezpieczenie otwarcia drzwi meblowych
 GB Multi-purpose latches
 D Schutzsicherung gegen das Öffnen der Möbeltüren
 RUS Блокатор открывания дверей мебели
 CZ Pojistka proti otevření nábytkových dveří
 RO Protecție deschidere uși mobilă
 H Bútorajtó-ütököző
 E Protectores para las portezuelas de muebles para prevenir su apertura



No.	pcs	
74776	2	12/216

- PL Hak
 GB Hook
 D Haken
 RUS Крюк
- CZ Hák
 RO Cârlig
 H Kampó
 E Gancho



No.	L (mm)	pcs packing	
78450	300	30	30/120

PL Hak
GB Hook
D Haken
RUS Крюк

CZ Hák
RO Cârîg
H Kampó
E Gancho



No.	L (mm)	pcs packing	☐
78451	300	30	60/120

PL Wieszaki montowane do ściany
GB Storage hangers set
D Montagehaken für die Wand
RUS Крючки на стену

CZ Věšáky na montáž do stěny
RO Cârîge montate pe perete
H Falra szerelhető akasztó
E Ganchos para paredes

2
pcs

∅
9 mm

30 kg
(max)

PVC
COATED
POWŁOKA



VOREL

No.	∅ (mm)	pcs	☐
74681	9	2	12/108

PL Wieszaki montowane do ściany
GB Storage hangers set
D Montagehaken für die Wand
RUS Крючки на стену

CZ Věšáky na montáž do stěny
RO Cârîge montate pe perete
H Falra szerelhető akasztó
E Ganchos para paredes

5
pcs

∅
6 mm

15 kg
(max)

PVC
COATED
POWŁOKA



VOREL

No.	∅ (mm)	pcs	☐
74688	6	5	24/96

PL Klipsy do przewodów
GB Cable clips
D Kabelspangen
RUS Скобы для кабеля

CZ Spony na kabely
RO Cleme pt. cabluri
H Kábelrögzítő
E Clips para cables

TPR



VOREL

No.	size / rozmiar (mm)	pcs	☐
74973	25x25x10	6	25/300
74974	37x35x15	4	25/200
74975	60x50x25	2	25/200

PL Wieszaki montowane do ściany
GB Storage hangers set
D Montagehaken für die Wand
RUS Крючки на стену

CZ Věšáky na montáž do stěny
RO Cârîge montate pe perete
H Falra szerelhető akasztó
E Ganchos para paredes

4
pcs

∅
6 mm

20 kg
(max)

PVC
COATED
POWŁOKA



VOREL

No.	∅ (mm)	pcs	☐
74680	6	4	24/96

PL Wieszaki montowane do ściany
GB Storage hangers set
D Montagehaken für die Wand
RUS Крючки на стену

CZ Věšáky na montáž do stěny
RO Cârîge montate pe perete
H Falra szerelhető akasztó
E Ganchos para paredes

2
pcs

∅
11 mm

60 kg
(max)

PVC
COATED
POWŁOKA



VOREL

No.	∅ (mm)	pcs	☐
74685	11	2	12/48

PL Wieszaki montowane do ściany
GB Storage hangers set
D Montagehaken für die Wand
RUS Крючки на стену

CZ Věšáky na montáž do stěny
RO Cârîge montate pe perete
H Falra szerelhető akasztó
E Ganchos para paredes

8
pcs

∅
6 mm

15 kg
(max)

PVC
COATED
POWŁOKA

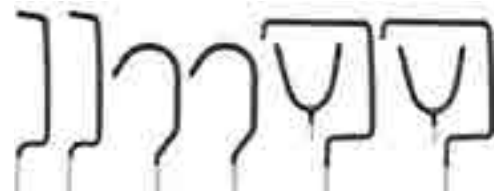

VOREL

No.	∅ (mm)	pcs	☐
74689	6	8	12/48

PL Organizer gumowy „żółwik”
GB Rubber organizer „turtle”
D Gummiorganizer „Schildkröte”
RUS Резиновый органайзер для проводов «черепашка»

CZ Gumový organizér „želvička”
RO Organizator de cauciuc „broască țestoasă”
H Gumi „teknősbéka” kábelrendező
E Organizador de caucho tipo „tortuga”

1 m
(max)

POWER OF
COATED CABLE
MOC MAX.
NĂMÎRIȚO
KABELA
1250 W



VOREL

No.	☐
74983	25/300

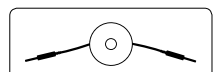





21

Health & safety products
Artykuły BHP



Gloves Rękawice		310-313
Goggles & shields Okulary i osłony przeciwodpryskowe		313-314
Dust masks Maski przeciwpyłowe		314-315
Welding goggles & masks Okulary i maski spawalnicze		315-318
Knee pads Nakolanniki		318-319
Hearing protectors Nauszniki przeciwhałasowe		319
Safety helmets Kaski ochronne		319

Rain boots Kalosze		319-320
Working shoes Buty robocze		321
Safety sandals Sandaly robocze		321
Shoes accessories Akcesoria do obuwia		321
Working clothes Odzież robocza		322-323
Safety vests Kamizelki ostrzegawcze		322
Waterproof jackets Kurtki przeciwdeszczowe		322
Garden trousers Spodnie ogrodnicze		322
Working clothes Odzież robocza		323

PL Rękawice robocze CZ Pracovní rukavice
 GB Working gloves RO Mănuși
 D Arbeitshandschuh H Védőkesztyű
 RUS Перчатки E Guantes



No.	
74000	12/120

PL Rękawice robocze CZ Pracovní rukavice
 GB Working gloves RO Mănuși
 D Arbeitshandschuh H Védőkesztyű
 RUS Перчатки E Guantes



No.	
74094	240

PL Rękawice robocze
 GB Working gloves
 D Arbeitshandschuh
 RUS Перчатки
 CZ Pracovní rukavice
 RO Mănuși
 H Védőkesztyű
 E Guantes



No.	pairs / pary	size / rozmiar	packing	
74102	1	8		10/240
74103	5	8		48

PL Rękawice robocze
 GB Working gloves
 D Arbeitshandschuh
 RUS Перчатки
 CZ Pracovní rukavice
 RO Mănuși
 H Védőkesztyű
 E Guantes



No.	pairs / pary	packing	
74106	1		10/240
74107	5		48

PL Rękawice robocze CZ Pracovní rukavice
 GB Working gloves RO Mănuși
 D Arbeitshandschuh H Védőkesztyű
 RUS Перчатки E Guantes



No.	
74004	12/120

PL Rękawice robocze
 GB Working gloves
 D Arbeitshandschuh
 RUS Перчатки
 CZ Pracovní rukavice
 RO Mănuși
 H Védőkesztyű
 E Guantes



No.	pairs / pary	
74100	1	12/300

PL Rękawice robocze
 GB Working gloves
 D Arbeitshandschuh
 RUS Перчатки
 CZ Pracovní rukavice
 RO Mănuși
 H Védőkesztyű
 E Guantes



No.	
74104	10/240

PL Rękawice robocze CZ Pracovní rukavice
 GB Working gloves RO Mănuși
 D Arbeitshandschuh H Védőkesztyű
 RUS Перчатки E Guantes

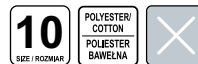

No.	
74108	240

PL Rękawice robocze
GB Working gloves
D Arbeitshandschuh
RUS Перчатки
CZ Pracovní rukavice
RO Mănuși
H Védőkesztyű
E Guantes



No.	pairs / pary	size / rozmiar	
74110	1	9	12/300

PL Rękawice robocze
GB Working gloves
D Arbeitshandschuh
RUS Перчатки
CZ Pracovní rukavice
RO Mănuși
H Védőkesztyű
E Guantes



No.	size / rozmiar	
74126	8	12/300
74132	9	12/300
74133	10	12/300

PL Rękawice robocze
GB Working gloves
D Arbeitshandschuh
RUS Перчатки
CZ Pracovní rukavice
RO Mănuși
H Védőkesztyű
E Guantes



No.	size / rozmiar	
74128	8	12/300
74136	9	12/300
74137	10	12/300

PL Rękawice ogrodnicze
GB Gardening gloves
D Arbeitshandschuh
RUS Перчатки

CZ Pracovní rukavice
RO Mănuși
H Védőkesztyű
E Guantes



No.	size / rozmiar	
74121	8	50/1000

PL Rękawice robocze
GB Working gloves
D Arbeitshandschuh
RUS Перчатки
CZ Pracovní rukavice
RO Mănuși
H Védőkesztyű
E Guantes



No.	size / rozmiar	
74125	8	12/300
74130	9	12/300
74131	10	12/300

PL Rękawice robocze
GB Working gloves
D Arbeitshandschuh
RUS Перчатки
CZ Pracovní rukavice
RO Mănuși
H Védőkesztyű
E Guantes



No.	size / rozmiar	
74127	8	12/300
74134	9	12/300
74135	10	12/300

PL Rękawice ogrodnicze
GB Gardening gloves
D Arbeitshandschuh
RUS Перчатки

CZ Pracovní rukavice
RO Mănuși
H Védőkesztyű
E Guantes



No.	size / rozmiar	
74117	8	50/1000

PL Rękawice ogrodnicze
GB Gardening gloves
D Arbeitshandschuh
RUS Перчатки

CZ Pracovní rukavice
RO Mănuși
H Védőkesztyű
E Guantes



No.	size / rozmiar	
74123	8	50/1000

PL Rękawice ogrodnicze
GB Gardening gloves
D Arbeitshandschuh
RUS Перчатки

CZ Pracovní rukavice
RO Mănuși
H Védőkesztyű
E Guantes



No.	size / rozmiar	
74113	8	50/1000

PL Rękawice robocze
GB Working gloves
D Arbeitshandschuh
RUS Перчатки
CZ Pracovní rukavice
RO Mănuși
H Védőkesztyű
E Guantes



No.	
74150	12/120

PL Rękawice robocze
GB Working gloves
D Arbeitshandschuh
RUS Перчатки
CZ Pracovní rukavice
RO Mănuși
H Védőkesztyű
E Guantes



No.	
74160	12/120

PL Rękawice robocze
GB Working gloves
D Arbeitshandschuh
RUS Перчатки
CZ Pracovní rukavice
RO Mănuși
H Védőkesztyű
E Guantes



No.	size / rozmiar	
74146	10	12/120

PL Rękawice ogrodnicze
GB Gardening gloves
D Arbeitshandschuh
RUS Перчатки

CZ Pracovní rukavice
RO Mănuși
H Védőkesztyű
E Guantes



No.	size / rozmiar	
74115	8	50/1000

PL Rękawice robocze
GB Working gloves
D Arbeitshandschuh
RUS Перчатки
CZ Pracovní rukavice
RO Mănuși
H Védőkesztyű
E Guantes



No.	
74151	12/120

PL Rękawice robocze
GB Working gloves
D Arbeitshandschuh
RUS Перчатки
CZ Pracovní rukavice
RO Mănuși
H Védőkesztyű
E Guantes



No.	
74162	600

PL Rękawice robocze
GB Working gloves
D Arbeitshandschuh
RUS Перчатки
CZ Pracovní rukavice
RO Mănuși
H Védőkesztyű
E Guantes

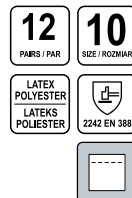

No.	pairs / pary	size / rozmiar	
74145	12	10	10

PL Rękawice robocze
GB Working gloves
D Arbeitshandschuh
RUS Перчатки
CZ Pracovní rukavice
RO Mănuși
H Védőkesztyű
E Guantes

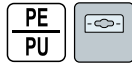

No.	size / rozmiar	
74079	9	12/120
74080	10	12/120

PL Rękawice robocze
GB Working gloves
D Arbeitshandschuh
RUS Перчатки
CZ Pracovní rukavice
RO Mănuși
H Védőkesztyű
E Guantes

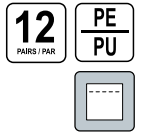

No.	pairs / pary	size / rozmiar	
74077	12	9	10
74078	12	10	10

PL Rękawice robocze
GB Working gloves
D Arbeitshandschuh
RUS Перчатки
CZ Pracovní rukavice
RO Mănuși
H Védőkesztyű
E Guantes

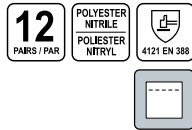

No.	pairs / pary	size / rozmiar	
74152	12	8	20
74153	12	9	20
74154	12	10	20

PL Rękawice robocze ocieplane
GB Insulated gloves
D Arbeitshandschuh
RUS Перчатки
CZ Pracovní rukavice
RO Mănuși
H Védőkesztyű
E Guantes



No.	size / rozmiar	
74149	10	12/120

PL Rękawice ochronne, ocieplane
GB Insulated gloves
D Isolierhandschuhe
RUS Утепленные перчатки

CZ Zimní rukavice
RO Mănuși izolate
H Szigetelt kesztyű
E Gants isolés



No.	size / rozmiar	
74148	10	12/120

PL Rękawice robocze
GB Working gloves
D Arbeitshandschuh
RUS Перчатки
CZ Pracovní rukavice
RO Mănuși
H Védőkesztyű
E Guantes



No.	size / rozmiar	
74140	10	12/120

PL Rękawice robocze
GB Working gloves
D Arbeitshandschuh
RUS Перчатки
CZ Pracovní rukavice
RO Mănuși
H Védőkesztyű
E Guantes



No.	size / rozmiar	
74081	9	12/120
74082	10	12/120

PL Oslona twarzy przeciwdrobnok
GB Polycarbonate protection shield
D Schutzmaske
RUS Маска защитная

CZ Ochranná přilba /polyuhličitan/
RO Masca protectie
H Hegesztősisak /polivenglán/
E Pantalla protectora antipedacitos



No.	
74459	25/50

PL Osłona twarzy przeciwdpryskowa
 GB Polycarbonate protection shield
 D Schutzmaske
 RUS Маска защитная
 CZ Ochranná přilba /polyuhličitan/
 RO Masca protectie
 H Hegesztősisak /polivenglán/
 E Pantalla protectora antipedacitos



No.		
74460		20

PL Okulary ochronne
 GB Safety glasses
 D Schutzbrille
 RUS Очки защитные открытые

CZ Ochranné brýle
 RO Ochelari pt. protectie
 H Védőszemüveg
 E Gafas protectoras



No.	type	
74502	HF-110	12/240

PL Okulary ochronne
 GB Safety glasses
 D Schutzbrille
 RUS Очки защитные открытые

CZ Ochranné brýle
 RO Ochelari pt. protectie
 H Védőszemüveg
 E Gafas protectoras



No.	type	
74504	DY-8526	15/150

PL Okulary ochronne
 GB Safety glasses
 D Schutzbrille
 RUS Очки защитные открытые

CZ Ochranné brýle
 RO Ochelari pt. protectie
 H Védőszemüveg
 E Gafas protectoras



No.	type	
74509	HF-105	10/100

PL Okulary ochronne
 GB Safety glasses
 D Schutzbrille
 RUS Очки защитные открытые

CZ Ochranné brýle
 RO Ochelari pt. protectie
 H Védőszemüveg
 E Gafas protectoras



No.	type	
74501	TVS	12/240

PL Okulary ochronne
 GB Safety glasses
 D Schutzbrille
 RUS Очки защитные открытые

CZ Ochranné brýle
 RO Ochelari pt. protectie
 H Védőszemüveg
 E Gafas protectoras



No.	type	
74503	DY-8525	15/150

PL Okulary ochronne
 GB Safety glasses
 D Schutzbrille
 RUS Очки защитные открытые

CZ Ochranné brýle
 RO Ochelari pt. protectie
 H Védőszemüveg
 E Gafas protectoras



No.	type	
74508	HF-103	10/120

PL Półmaski filtrujące jednorazowe
 GB Disposable dust masks
 D Atemschutzmaske
 RUS Респиратор противопылевой одноразовый
 CZ Protiprášná maska
 RO Masca prař
 H Eldobható porvédőmaszk
 E Mascarella desechable para protecci3n contra polvo

5 PCS

FFP1 NR



No.	pcs packing	
74540	5	25/100

- PL Półmaski filtrujące jednorazowe
- GB Disposable dust masks
- D Atemschutzmaske
- RUS Респиратор противопылевой одноразовый
- CZ Protiprašná maska
- RO Masca praf
- H Eldobható porvédőmaszk
- E Mascarilla desechable para protección contra polvo



No.	pcs packing	
74541	5	15/60

- PL Półmaski filtrujące jednorazowe
- GB Disposable dust masks
- D Atemschutzmaske
- RUS Респиратор противопылевой одноразовый
- CZ Protiprašná maska
- RO Masca praf
- H Eldobható porvédőmaszk
- E Mascarilla desechable para protección contra polvo



No.	pcs packing	
74543	5	15/60

- PL Okulary spawalnicze
- GB Welding goggles
- D Schweisserbrille
- RUS Очки газосварщика
- CZ Brýle svářečské
- RO Ochelari pt. sudura
- H Hegesztőszemüveg
- E Gafas para soldar

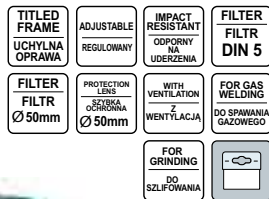

No.		
74400		25/100

- PL Okulary spawalnicze
- GB Welding goggles
- D Schweisserbrille
- RUS Очки газосварщика
- CZ Brýle svářečské
- RO Ochelari pt. sudura
- H Hegesztőszemüveg
- E Gafas para soldar

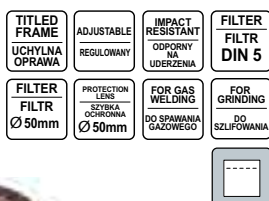

No.		
74411		10/100

- PL Półmaski filtrujące jednorazowe
- GB Disposable dust masks
- D Atemschutzmaske
- RUS Респиратор противопылевой одноразовый
- CZ Protiprašná maska
- RO Masca praf
- H Eldobható porvédőmaszk
- E Mascarilla desechable para protección contra polvo



No.	pcs packing	
74542	5	25/100

- PL Półmaska antysmogowa
- GB Anti pollution mask
- D Atemschutzmaske-Smogmaske
- RUS Антисмоговая полумаска
- CZ Ochranná maska proti znečišťování ovzduší
- RO Masca antipoluare
- H Eldobható porvédőmaszk, szelepes
- E Mascarilla desechable para



No.	type	
74555	VZ / PZ	50

- PL Okulary spawalnicze
- GB Welding goggles
- D Schweisserbrille
- RUS Очки газосварщика
- CZ Brýle svářečské
- RO Ochelari pt. sudura
- H Hegesztőszemüveg
- E Gafas para soldar

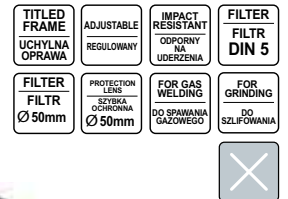

No.		
74410		5/100

- PL Maska spawalnicza
- GB Welding mask
- D Schweissermaske
- RUS Щиток сварщика
- CZ Svářečská maska
- RO Mască de sudură
- H Hegesztőpajzs
- E Mascara de soldador

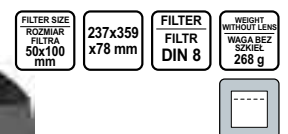

No.	type	
74440	TSM-3	30

- PL Maska spawalnicza
- GB Welding mask
- D Schweissermaske
- RUS Щиток сварщика
- CZ Svářečská maska
- RO Mască de sudură
- H Hegesztőpajzs
- E Mascara de soldador



FILTER SIZE
ROZMIAR
FILTRA
50x100
mm

222x372
x80 mm

FILTER
FILTR
DIN 10

WEIGHT
WITHOUT LENS
WAGA BEZ
SZKIEŁ
366 g

No.	type	
74442	TSM	30

- PL Maska spawalnicza
- GB Welding mask
- D Schweissermaske
- RUS Щиток сварщика
- CZ Svářečská maska
- RO Mască de sudură
- H Hegesztőpajzs
- E Mascara de soldador



FILTER SIZE
ROZMIAR
FILTRA
50x100
mm

257x450
x96 mm

WEIGHT
WITHOUT LENS
WAGA BEZ
SZKIEŁ
455 g

No.	type	
74450	TSD-3	20

- PL Przybica spawalnicza z podglądem
- GB Welding mask
- D Schweissermaske
- RUS Щиток сварщика с подсмотром
- CZ Svářečská přilba s nakoukáváním
- RO Mască de sudură cu geam
- H Hegesztősisak kitékintővel
- E Mascara de soldador con mirador



FILTER SIZE
ROZMIAR
FILTRA
50x100 mm
DIN 8-13

SPECTACLE
LENS SIZE
SZKIEŁO KITEKINTŐVEL
20x100 mm
(DIN 5)

225x290
x175 mm

FILTER
FILTR
DIN 10

WEIGHT
WITHOUT LENS
WAGA BEZ
SZKIEŁ
427 g

No.	type	
74448	PS-3	10

- PL Przybica spawalnicza
- GB Welding mask
- D Schweissermaske
- RUS Щиток сварщика
- CZ Svářečská přilba s nakoukáváním
- RO Mască de sudură cu geam
- H Hegesztősisak kitékintővel
- E Mascara de soldador con mirador



110x90
mm

WELDING FILTER
FILTR
SPAWALNICZY
12

No.		
74457		20



- PL Maska spawalnicza
- GB Welding mask
- D Schweissermaske
- RUS Щиток сварщика
- CZ Svářečská maska
- RO Mască de sudură
- H Hegesztőpajzs
- E Mascara de soldador



FILTER SIZE
ROZMIAR
FILTRA
50x100
mm

SPECTACLE
LENS SIZE
SZKIEŁO KITEKINTŐVEL
20x100 mm
(DIN 5)

222x372
x80 mm

FILTER
FILTR
DIN 10

WEIGHT
WITHOUT LENS
WAGA BEZ
SZKIEŁ
408 g

No.	type	
74443	TSM	20

- PL Przybica spawalnicza z podglądem
- GB Welding mask
- D Schweissermaske
- RUS Щиток сварщика с подсмотром
- CZ Svářečská přilba s nakoukáváním
- RO Mască de sudură cu geam
- H Hegesztősisak kitékintővel
- E Mascara de soldador con mirador



FILTER SIZE
ROZMIAR
FILTRA
50x100 mm
DIN 8-13

SPECTACLE
LENS SIZE
SZKIEŁO KITEKINTŐVEL
20x100 mm
(DIN 5)

195x265
x170 mm

FILTER
FILTR
DIN 10

WEIGHT
WITHOUT LENS
WAGA BEZ
SZKIEŁ
332 g

No.	type	
74447	PSMP	20

- PL Maska spawalnicza
- GB Welding mask
- D Schweissermaske
- RUS Щиток сварщика
- CZ Svářečská maska
- RO Mască de sudură
- H Hegesztőpajzs
- E Mascara de soldador



110x90
mm

FILTER
FILTR
DIN 12



No.		
74441		20

- PL Przybica spawalnicza samościemniająca
- GB Auto-darkening welding helmet
- D Schweissermaske, selbstverdunkelnd
- RUS Маска для сварки, самостоятельно затемняющаяся
- CZ Svářečská kukla samostmívaci
- RO Mască de sudură auto-întunecare
- H Önmagától sötétedő hegesztőpajzs
- E Casco auto-oscurecedor para soldadura



LIGHT STATE
STAN JASNY
4

DARK STATE
STAN CIEMNY
9-13

REACTION
TIME
CZAS
REAKCJI
1/25000 s

2x3V
CR2032
NOT INCLUDED
NIE DOŁĄCZONY

+5°C - +55°C
WORKING
TEMPERATURE
TEMPERATURA
PRACY



No.		
74435		6

- PL Przyłbica spawalnicza samościemniająca
 GB Auto-darkening welding helmet
 D Schweissmaske, selbstverdunkelnd
 RUS Маска для сварки, самостоятельно затемняющаяся
 CZ Svářečská kukla samostmívaci
 RO Mască de sudură auto-întunecare
 H Őnmagától sötétedő hegesztőpajzs
 E Casco auto-oscurecedor para soldadura



LIGHT STATE STAN JASNY 4	DARK STATE STAN CIEMNY 9-13	REACTION TIME - CZAS REAKCJI 1/15000 s
0,25 - 0,25 s RESPONSE TIME CZAS ODKADANIA	0,25 - 0,8 ms GRINDING TIME CZAS ZACIEMNIENIA	VIEWING AREA POLI WIDZENIA 92x42 mm
2 ARC SENSOR LECZA CIEMNIOWI CZAS	GRINDING WELDING SZLIFOWANIE SPAWANIE	SENSITIVITY CZUŁOŚĆ
DELAY OPÓZNIENIE	SOLAR CELL OGNIWO SŁONECZNE	AUTOMATIC POWER ON/OFF AUTOMATYCZNE MAGCENIE / WYKACENIE
-5°C/+55°C WORKING TEMPERATURE TEMPERATURA PRACY	UV / IR	3 POINT HEADGEAR WIEŻBA 3 PUNKTOWA
OPTICAL CHARACTERISTIC WŁAŚCIWOŚCI OPTYCZNE 1 / 1 / 1 / 2		

STHOR

No.	
74480	6

- PL Przyłbica z osłoną wymienną
 GB Face shield with PC visor
 D Schweisserschutzhelm mit austauschbarer Abdeckung
 RUS Шлем с заменяемой защитой
 CZ Štít s vyměnitelným krytem
 RO Vizieră cu protecție schimbabilă
 H Arcvédő cserélhető pajzssal
 E Antifaz con protección reemplazable

VISOR OSŁONA 395x200 mm



VOREL

No.	
74461	40

- PL Przyłbica z osłoną wymienną i nausznikami przeciwhałasowymi
 GB Face shield with steel mesh and ear muff
 D Schweisserschutzhelm mit austauschbarer Abdeckung und Ohrenschützer gegen Lärm
 RUS Шлем с заменяемой защитой и наушниками против шума
 CZ Štít s vyměnitelným krytem a chrániči proti hluku
 RO Vizieră cu protecție schimbabilă și căști de protecție antigomot
 H Arcvédő cserélhető pajzssal és fülvédő kagylóval
 E Antifaz con protección reemplazable y protectores de oídos

MESH OSŁONA 395x200 mm



VOREL

No.	
74462	40

- PL Przyłbica spawalnicza
 GB Welding helmet
 D Schweissmaske
 RUS Щиток сварщика
- CZ Svářečská maska
 RO Mască de sudură
 H Hegesztőpajzs
 E Mascara de soldador

108x50 mm
WELDING FILTER FILTR SPAWALNICZY 10



VOREL

No.	
74449	12

- PL Osłona wymienna z tworzywa
 GB PC visor
 D Austauschbare Abdeckung aus Kunststoff
 RUS Заменяемая защита из пластмассы
 CZ Vyměnitelný kryt z plastu
 RO Protecție schimbabilă din plastic
 H Cserélhető, műanyag pajzs
 E Protección reemplazable de materia plástica

--



VOREL

No.	size (mm)	
74463	305x200	200
74464	395x200	150

- PL Osłona filtra
 GB Filter shield
 D Filterabdeckung
 RUS Кожух фильтра
- CZ Ochrana filtru
 RO Aparatoare de filtru
 H Szűrőfedél
 E Protección de filtro

--

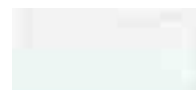

No.	mm	type / typ	
74451	50x100	DIN 0	150

- PL Filtr spawalniczy CZ Filtr svářečský
 GB Welding filter RO Filtru pt. sudări
 D Vorsatzglas H Hegesztőszűrő
 RUS Фильтр для сварки E Pantalla de filtro de soldador



No.	mm	type / typ	
74452	50x100	DIN 8	100
74453	50x100	DIN 9	100
74454	50x100	DIN 10	100
74455	50x100	DIN 11	100
74456	50x100	DIN 12	100

- PL Osłona filtra CZ Ochranná folie filtru
 GB Filter protection RO Carcasă filtru
 D Filtereinsatz H Szűrő-védőburkolat
 RUS Кожух фильтра E Protección del filtro



No.	mm	type	for / dla	
74466	350x200	OT 1-N	74460	10/100

- PL Nakolanniki CZ Chrániče kolen
 GB Knee pads RO Genunchiere
 D Knieschützer H Térdvédő
 RUS Наколенники E Rodilleras



No.	
74600	50

- PL Nakolanniki CZ Chrániče kolen
 GB Knee pads RO Genunchiere
 D Knieschützer H Térdvédő
 RUS Наколенники E Rodilleras



No.	
74622	50

- PL Osłona filtra CZ Ochranná folie filtru
 GB Filter protection RO Carcasă filtru
 D Filtereinsatz H Szűrő-védőburkolat
 RUS Кожух фильтра E Protección del filtro



No.	mm	type	for / dla	
74467	345x190	OTS	74459	100

- PL Osłona filtra przyłbicy samościemniającej
 GB Self-dimming helmet filter protection
 D Filtereinsatz eines selbstabdunkelnden Schutzhelms
 RUS Кожух фильтра самозатемняющегося щитка
 CZ Ochranná folie filtru samostatně ztmavujícího štítka
 RO Carcasă filtru vizieră heliomatică
 H Hegesztőpajzs szűrő, önsötétető
 E Protección del filtro de visera autooscurecedora

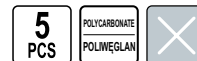

No.	mm	pcs	
74439	90x110	5	20

- PL Nakolanniki CZ Chrániče kolen
 GB Knee pads RO Genunchiere
 D Knieschützer H Térdvédő
 RUS Наколенники E Rodilleras



No.	
74610	20

- PL Nakolanniki CZ Chrániče kolen
 GB Knee pads RO Genunchiere
 D Knieschützer H Térdvédő
 RUS Наколенники E Rodilleras



No.	
74624	12/24

PL Nakolanniki CZ Chrániče kolen
 GB Knee pads RO Genunchiere
 D Knieschützer H Térvédő
 RUS Наколенники E Rodilleras



No.	☐
74601	24

PL Nauszniki przeciwhałasowe CZ Chrániče sluchu
 GB Ear muff RO Antifoane
 D Gehörschutz H Fülvédőt
 RUS Средства защиты слуха E Protectores de la vista



No.	☐
74580	60

PL Kask ochronny
 GB Safety helmet
 D Schutzhelm
 RUS Каска защитная
 CZ Ochranná přilba
 RO Cască de protecție
 H Védősisak
 E Casco de protección



No.	colour / kolor	☐
74190	○	40
74191	●	40
74192	●	40
74193	●	40
74194	●	40
74195	●	40

PL Nakolanniki CZ Chrániče kolen
 GB Knee pads RO Genunchiere
 D Knieschützer H Térvédő
 RUS Наколенники E Rodilleras



No.	☐
74602	6/36

PL Nauszniki przeciwhałasowe CZ Chrániče sluchu
 GB Ear muff RO Antifoane
 D Gehörschutz H Fülvédőt
 RUS Средства защиты слуха E Protectores de la vista



No.	☐
74581	10/60

PL Kalosze damskie CZ Dámské galoše
 GB Women's rain boots RO Cizme damă
 D Damen - Gummistiefel H Női gumicsizma
 RUS Галоши женские E Chanclas para mujer



No.	size / rozmiar	model	☐
72831	36	LUNA	7
72832	37	LUNA	7
72833	38	LUNA	7
72834	39	LUNA	5
72835	40	LUNA	5
72836	41	LUNA	5

PL Kalosze męskie
GB Men's rain boots
D Herren - Gummistiefel
RUS Галоши мужские

CZ Pánské galoše
RO Cizme bărbați
H Férfi gumicsizma
E Chanclos para hombre



demar

No.	size / rozmiar	model	
72840	41	PREDATOR XL	6
72841	42	PREDATOR XL	4
72842	43	PREDATOR XL	4
72843	44	PREDATOR XL	4
72844	45	PREDATOR XL	4
72845	46	PREDATOR XL	6
72846	47	PREDATOR XL	6

PL Kalosze damskie
GB Women's rain boots
D Damen - Gummistiefel
RUS Галоши женские

CZ Dámské galoše
RO Cizme damă
H Női gumicsizma
E Chanclos para mujer



demar

No.	size / rozmiar	model	
72850	36	RAINY BLACK	10
72851	37	RAINY BLACK	10
72852	38	RAINY BLACK	10
72853	39	RAINY BLACK	10
72854	40	RAINY BLACK	10

PL Buty gumowo - filcowe
GB Felt PVC boots
D Gummistiefel mit Filtz
RUS Сапоги резиновые с войлоком

CZ Holínky s filcem
RO Cizme PVC
H Gumi - filc csizma
E Botas de goma fieltro

demar

No.	size / rozmiar	
72871	40	5
72872	41	5
72873	42	5
72874	43	5
72875	44	5
72876	45	5
72877	46	5

PL Kalosze męskie
GB Men's rain boots
D Herren - Gummistiefel
RUS Галоши мужские

CZ Pánské galoše
RO Cizme bărbați
H Férfi gumicsizma
E Chanclos para hombre



demar

No.	size / rozmiar	model	
72881	40	FARMER	4
72882	41	FARMER	4
72883	42	FARMER	4
72884	43	FARMER	4
72885	44	FARMER	4
72886	45	FARMER	4
72887	46	FARMER	4
72888	47	FARMER	4

PL Kalosze męskie
GB Men's rain boots
D Herren - Gummistiefel
RUS Галоши мужские

CZ Pánské galoše
RO Cizme bărbați
H Férfi gumicsizma
E Chanclos para hombre

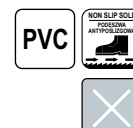

demar

No.	size / rozmiar	model	
72858	41	GRAND BLACK	8
72859	42	GRAND BLACK	8
72860	43	GRAND BLACK	8
72861	44	GRAND BLACK	8
72862	45	GRAND BLACK	6
72863	46	GRAND BLACK	6
72864	47	GRAND BLACK	6

PL Buty gumowo - filcowe
GB Felt PVC boots
D Gummistiefel mit Filtz
RUS Сапоги резиновые с войлоком

CZ Holínky s filcem
RO Cizme PVC
H Gumi - filc csizma
E Botas de goma fieltro



PL Sandały robocze CZ Pracovní polobotky
 GB Safety sandals RO Bocanci de lucru
 D Arbeitshalbschuhe H Munkavédelmi félcipő
 RUS Полуботинки рабочие E Zapato de trabajo



No.	size / rozmiar	model	
72801	39	SALTA	10
72802	40	SALTA	10
72803	41	SALTA	10
72804	42	SALTA	10
72805	43	SALTA	10
72806	44	SALTA	10
72807	45	SALTA	10
72808	46	SALTA	10
72809	47	SALTA	10

PL Płynny tłuszcz do obuwia CZ Olejový spray na obuv
 GB Oil spray RO Spray intretinere incaltaminte
 D Wartungs-Spray Schuhe H Cipőápoló olaj
 RUS Жидкий жир для обуви E Aceite para botas



No.	ml	
72890	150	20

PL Antybakteryjna wkładka do butów CZ Antibakteriální vložka do bot
 GB Antibacterial insole RO Tălpici antibacterieni
 D Antibakterielle Einlage für Schuhe H Antibakteriális cipőbetét
 RUS Антибактериальная стелька E Plantilla antibacterial

No.	size / rozmiar	thickness / grubość (mm)	
72683	39 / 40	3.2	50
72684	41 / 42	3.2	50
72685	43 / 44	3.2	50
72686	45 / 46	3.2	50

PL Sandały robocze CZ Pracovní polobotky
 GB Safety sandals RO Bocanci de lucru
 D Arbeitshalbschuhe H Munkavédelmi félcipő
 RUS Полуботинки рабочие E Zapato de trabajo



No.	size / rozmiar	model	
72821	39	SERRA	10
72822	40	SERRA	10
72823	41	SERRA	10
72824	42	SERRA	10
72825	43	SERRA	10
72826	44	SERRA	10
72827	45	SERRA	10
72828	46	SERRA	10
72829	47	SERRA	10

PL Spray ożywiający kolor do nubuku i zamszu CZ Spray na semišovou obuv
 GB Revivint spray RO Spray revitalizant incaltaminte
 D Wildleder und Nubuk Pflegespray H Nubukvelourápoló spray
 RUS Спрей освежающий цвет нубука и замши E Spray para suede



No.	ml	
72891	250	20



- PL Kamizelka ostrzegawcza CZ Výstražná vesta
 GB Reflective vest RO Vestă de avertizare
 D Warnweste H Fényvisszaverő mellény
 RUS Жилет безопасности E Chaleco reflectante

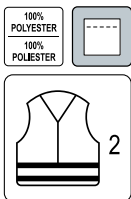

No.	size / rozmiar	model	
74660	L	VEST-O	100
74661	XL	VEST-O	100
74662	XXL	VEST-O	100
74663	XXXL	VEST-O	100

- PL Kurtka przeciwdeszczowa CZ Bunda do deště
 GB Waterproof jacket RO Giacă impermeabilă
 D Regenjacke H Vizhatlan dzseki
 RUS Куртка-дождевик E Chaqueta impermeable

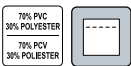

No.	size / rozmiar	
74626	L	20
74627	XXL	20
74628	XXXL	20

- PL Komplet przeciwdeszczowy moro CZ Oblek maskáčový do deště
 GB Rain suit military style RO Îmbrăcămintă de ploaie camuflaj
 D Regenbekleidung militärischen Stil H Eső ruházat
 RUS Дождь костюмы военный стиль E Ropa de lluvia camo



No.	size / rozmiar	
74646	L	20
74647	XXL	20

- PL Kamizelka ostrzegawcza CZ Výstražná vesta
 GB Reflective vest RO Vestă de avertizare
 D Warnweste H Fényvisszaverő mellény
 RUS Жилет безопасности E Chaleco reflectante

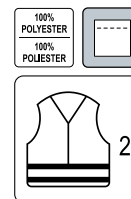

No.	size / rozmiar	model	
74664	L	VEST-G	100
74665	XL	VEST-G	100
74666	XXL	VEST-G	100
74667	XXXL	VEST-G	100

- PL Plaszcz przeciwdeszczowy CZ Placozka proti dažďu
 GB Raincoat RO Placoză
 D Regenmantel H Vizhatlan dzseki
 RUS Дождевик E Chaqueta impermeable

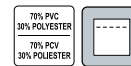

No.	size / rozmiar	
74631	XL	10
74632	XXL	10
74633	XXXL	10

- PL Spodnie ogrodnicze CZ Zahradnicke kalhoty
 GB Garden trousers RO Pantaloni pt. grădinărit
 D Gartenhosen H Kertész nadrág
 RUS Брюки садовые E Pantalón de jardinería



No.	size / rozmiar	
72900	S	10
72901	M	10
72902	L	10
72903	XL	10

PL Ubranie robocze CZ Pracovní oděv
 GB Working clothes RO Haine de lucru
 D Arbeitskleidung H Munkaruha
 RUS Рабочая одежда E Ropa de trabajo



80% POLYESTER
 20% COTTON
 80% POLYESTER
 20% BAMBACIA



No.	size / rozmiar	model	
74220	S	EBRO	24
74221	M	EBRO	24
74222	L	EBRO	24
74223	XL	EBRO	24

Memo

22

Electric products
Artykuły elektryczne



Extension cords & cable reels
Przedłużacze listwowe
i bębnowe

.....326-327

Extension cords French type

Przedłużacze elektryczne z uziemieniem..... 326

Extension cords

Przedłużacze elektryczne bez uziemienia..... 326

Christmas tree extension cables

Przedłużacze choinkowe..... 327

Cable reels French type

Przedłużacze bębnowe z uziemieniem..... 327

Adaptors
Rozgałęźniki

.....327-328

Lamps
Lampy

.....328-335

Halogen projectors

Lampy halogenowe..... 328

Halogen bulbs

Żarniki do lamp halogenowych..... 328

LED floodlights

Naświetlacze LED..... 329

Workshop lamps

Lampy warsztatowe..... 330

LED flashlights

Latarki diodowe..... 333

Bicycle lamps

Lampy rowerowe..... 334

Motion detectors
Czujniki ruchu

.....335



PL Przedłużacz elektryczny z uziemieniem
 GB Cord extension with earthing
 D Tischsteckdose Bolzenanschl
 RUS Удлинитель электрический с заземлением

CZ Elektrický prodloužovač
 RO Prelungitor electric
 H Elektromos hosszabbító
 E Extensión electr.



No.	L (m)	☺	type	📦
72500	1.5	3	E	12/48
72501	1.5	4	E	12/48
72504	3.0	3	E	12/48
72505	3.0	4	E	12/48
72506	3.0	5	E	12/48
72508	5.0	3	E	12/48
72509	5.0	4	E	12/48
72510	5.0	5	E	12/48

PL Przedłużacz elektryczny bez uziemienia
 GB Cord extension without earthing
 D Tischsteckdose ohne Nullleitung
 RUS Удлинитель электрический без заземления

CZ Elektrický prodloužovač
 RO Prelungitor electric
 H Elektromos hosszabbító
 E Extensión electr.



No.	L (m)	☺	type	📦
72484	1.5	3	C	12/48
72486	1.5	4	C	12/48
72489	3.0	3	C	12/48
72490	3.0	4	C	12/48
72493	5.0	3	C	12/48
72494	5.0	4	C	12/48

PL Przedłużacz elektryczny z uziemieniem
 GB Cord extension with earthing
 D Tischsteckdose Bolzenanschl
 RUS Удлинитель электрический с заземлением

CZ Elektrický prodloužovač
 RO Prelungitor electric
 H Elektromos hosszabbító
 E Extensión electr.



No.	L (m)	☺	type	📦
72625	1.5	3	E	12/48
72626	3.0	3	E	12/48
72627	5.0	3	E	12/48
72630	1.5	4	E	12/48
72631	3.0	4	E	12/48
72632	5.0	4	E	12/48

PL Przedłużacz elektryczny z uziemieniem
 GB Cord extension with earthing
 D Tischsteckdose Bolzenanschl
 RUS Удлинитель электрический с заземлением

CZ Elektrický prodloužovač
 RO Prelungitor electric
 H Elektromos hosszabbító
 E Extensión electr.



No.	L (m)	☺	type	📦
72615	1.5	3	E	12/48
72616	3.0	3	E	12/48
72617	5.0	3	E	12/48
72620	1.5	4	E	12/48
72621	3.0	4	E	12/48
72622	5.0	4	E	12/48

PL Przedłużacz elektryczny z wyłącznikiem
 GB Cord extension with switch
 D Tischsteckdose
 RUS Удлинитель электрический с выключателем

CZ Elektrický prodloužovač
 RO Prelungitor electric
 H Elektromos hosszabbító
 E Extensión para arbol de navidad verde

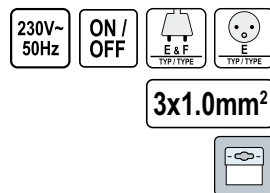

No.	L (m)	☺	type	📦
72524	1.5	3	E	12/48
72525	1.5	4	E	12/48
72526	1.5	5	E	12/48
72527	1.5	6	E	12/48
72528	3.0	3	E	12/48
72529	3.0	4	E	12/48
72530	3.0	5	E	12/48
72531	3.0	6	E	12/48
72532	5.0	3	E	12/48
72533	5.0	4	E	12/48
72534	5.0	5	E	12/48
72535	5.0	6	E	12/48

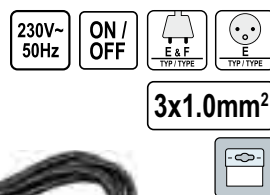

PL Przedłużacz
GB Garden extension cable
D Gartenverlängerungskabel
RUS Электроудлинитель

CZ Prodlužovací kabel zahradní
RO Prelungitor electric
H Kerti hosszabbító
E Cable de extensión para jardín

230V~
50Hz IP20
2x1.0mm²



No.	L (m)	
82671	10	10
82673	20	10
82675	30	5
82677	40	5

PL Przedłużacz zielony
GB Christmas tree extension cable
D Christbaum Verlängerungskabel
RUS Удлинитель

CZ Elektrický prodloužovač
RO Prelungitor electric
H Elektromos hosszabbító
E Extensión para árbol de navidad verde

2x0.75mm²
230V~
50Hz



No.	L (m)	
72451	3	10
72452	5	10

PL Przedłużacz bębnowy
GB Cable reel
D Kabeltrommel
RUS Удлинитель на катушке
CZ Bubenový prodloužovač
RO Prelungitor pe tambur
H Kábeldob
E Cable de prolongación de tambor



230V~
50Hz



No.	L (m)	wire gauge / průřez / przewodu (mm ²)		type	
82682	25	3x1.0	4	E	2
82684	40	3x1.0	4	E	2
82685	50	3x1.5	4	E	2

PL Rozgaleźnik
GB Adapter
D Abzweigung
RUS Разветвитель

CZ Rozdvojka
RO Splitter
H Oszlő
E Enchufe múltiple

230V~
50Hz 16A



No.		type	
72404	2	E	100

PL Przedłużacz
GB Garden extension cable
D Gartenverlängerungskabel
RUS Электроудлинитель

CZ Prodlužovací kabel zahradní
RO Prelungitor electric
H Kerti hosszabbító
E Cable de extensión para jardín

230V~
50Hz 10m
2x1.0mm²



No.	L (m)	
72455	10	10

PL Przedłużacz zwijany
GB Cable reel
D Kabeltrommel Bolzenanschl
RUS Удлинитель электрический
CZ Bubenový prodloužovač
RO Prelungitor pe tambur
H Kábeldob
E Extensión electr.



PVC



No.	L (m)	wire gauge / průřez / przewodu (mm ²)		type	
72570	15	3x1.0	4	E	4
72572	25	3x1.0	4	E	4
72573	30	3x1.5	4	E	4

PL Przedłużacz bębnowy, silowy
GB Cable reel
D Kabeltrommel
RUS Удлинитель силовой на катушке
CZ Bubenový prodloužovač
RO Prelungitor pe tambur
H Kábeldob
E Cable de prolongación de tambor



5x1.5mm²
230V~
50Hz 400V~
50Hz IP44

No.	L (m)	A	
82687	20	16	1

PL Rozgaleźnik
GB Adapter
D Abzweigung
RUS Разветвитель

CZ Rozdvojka
RO Splitter
H Oszlő
E Enchufe múltiple

230V~
50Hz 16A



No.		type	
72407	3	E	100

- PL Rozgałęźnik
GB Adapter
D Abzweigung
RUS Разветвитель
- CZ Rozdvojka
RO Splitter
H Oszlő
E Enchufe múltiple



No.	☺	type	☐
72400	2	C&E&F	200
72401	3	C&E&F	100
72402	4	C&E&F	100

- PL Lampa halogenowa przenośna
GB Portable halogen projector
D Halogenstrahler
RUS Проектор галогенный переносный
CZ Halogenové svítidlo přenosné
RO Lampa cu halogen mobilă
H Hordozható halogén lámpa
E Lámpara de halogeno portátil



No.	W	cabl / kabel (m)	☐
82788	120	1.7	12
82789	400	1.7	8

- PL Lampa halogenowa na stojaku
GB Halogen projector on tripod
D Halogenstrahler mit Stativ
RUS Проектор галогенный на штативе
CZ Halogenové svítidlo na stojanu
RO Lampa cu halogen pe stativ
H Állványos halogén lámpa
E Lámpara de halogeno sobre estante



No.	W	pcs packing	☐
82787	400	2	4

- PL Lampa halogenowa
GB Halogen lamp
D Halogenstrahler
RUS Галогенная фара-прожектор
CZ Halogenové svítidlo
RO Lampa cu halogen
H Halogén lámpa
E Lámpara de halogeno



No.	W	☐
82790	120	24
82791	400	16

- PL Lampa halogenowa na stojaku
GB Halogen projector on tripod
D Halogenstrahler mit Stativ
RUS Проектор галогенный на штативе
CZ Halogenové svítidlo na stojanu
RO Lampa cu halogen pe stativ
H Állványos halogén lámpa
E Lámpara de halogeno sobre estante



No.	W	☐
82786	400	4

- PL Żarniki do lamp halogenowych
GB Halogen projector bulbs
D Halogenstab
RUS Галогенная трубка
- CZ Žárovka do halogenové lampy
RO Bec cu halogen pt. proiector
H Halogén lámpaizzó
E Filamentos de bombillas halogenas



No.	W	lumens	h	☐
82771	120	2200	1000	50/200
82772	400	8600	1000	50/200

PL Reflektor diodowy CZ LED reflektor
 GB LED lamp RO Reflector diodă
 D Diodenscheinwerfer H Diodas reflektor
 RUS Светодиодный прожектор E Reflector de diodos



No.	W	lumens	h	cube icon
82841	10	800	25000	12

PL Reflektor diodowy CZ LED reflektor
 GB LED lamp RO Reflector diodă
 D Diodenscheinwerfer H Diodas reflektor
 RUS Светодиодный прожектор E Reflector de diodos



No.	W	lumens	h	cube icon
82843	30	2400	25000	12

PL Reflektor diodowy z czujnikiem ruchu
 GB LED lamp with motion detector
 D Diodenscheinwerfer mit Bewegungsmelder
 RUS Светодиодный прожектор с датчиком движения
 CZ LED reflektor se snimačem pohybu
 RO Reflector diodă cu senzor de mișcare
 H Diódás reflektor mozgásérzékelővel
 E Reflector de diodos con sensor de movimiento



No.	W	lumens	h	cube icon
82845	10	800	25000	12

PL Reflektor diodowy CZ LED reflektor
 GB LED lamp RO Reflector diodă
 D Diodenscheinwerfer H Diodas reflektor
 RUS Светодиодный прожектор E Reflector de diodos



No.	W	lumens	h	cube icon
82842	20	1600	25000	12

PL Reflektor diodowy CZ LED reflektor
 GB LED lamp RO Reflector diodă
 D Diodenscheinwerfer H Diodas reflektor
 RUS Светодиодный прожектор E Reflector de diodos



No.	W	lumens	h	cube icon
82844	50	4000	25000	12

PL Reflektor diodowy z czujnikiem ruchu
 GB LED lamp with motion detector
 D Diodenscheinwerfer mit Bewegungsmelder
 RUS Светодиодный прожектор с датчиком движения
 CZ LED reflektor se snimačem pohybu
 RO Reflector diodă cu senzor de mișcare
 H Diódás reflektor mozgásérzékelővel
 E Reflector de diodos con sensor de movimiento



No.	W	lumens	h	cube icon
82846	20	1600	25000	12

- PL Reflektor diodowy z czujnikiem ruchu
- GB LED lamp with motion detector
- D Diodenscheinwerfer mit Bewegungsmelder
- RUS Светодиодный прожектор с датчиком движения
- CZ LED reflektor se snímačem pohybu
- RO Reflector diodă cu senzor de mișcare
- H Diódás reflektor mozgásérzékelővel
- E Reflector de diodos con sensor de movimiento

30W	6000 K
2400 lm	230V~50Hz
25000 h	IP54
10m	



SMD LED



No.	W	lumens	h	
82847	30	2400	25000	12

- PL Diodowa lampa bezprzewodowa
- GB Rechargeable work lamp
- D Led Werkstattlampe
- RUS Светодиодная беспроводная лампа
- CZ Montážní lampa diodová bezpřívodová
- RO Lampă cu led fara cablu
- H Ledlámpa
- E Lámpara inalámbrica de diodos

12 LED	200 lm	CHARGING TIME CZAS ŁADOWANIA 4 h	WORK TIME CZAS PRACY 4.5 h
12 V 2000mAh Li-Ion	230V~50Hz BATTERY CHARGER ŁADOWNIKA	12 V BATTERY CHARGER ŁADOWNIKA	HOOK HAK
	MAGNETIC		



SMD LED



No.	LED	mAh	
82728	12	2000	20

- PL Diodowa lampa bezprzewodowa
- GB Rechargeable work lamp
- D Led Werkstattlampe
- RUS Светодиодная беспроводная лампа
- CZ Montážní lampa diodová bezpřívodová
- RO Lampă cu led fara cablu
- H Ledlámpa
- E Lámpara inalámbrica de diodos

3W	200 lm	3.7V 2000mAh Li-Ion	12V BATTERY CHARGER ŁADOWNIKA	FRONT LIGHTING FUNKCJA LATARKI
230V~50Hz BATTERY CHARGER ŁADOWNIKA	MAGNETIC	WORK TIME CZAS PRACY 4 h	CHARGING TIME CZAS ŁADOWANIA 4 h	HOOK HAK



COB LED



No.	W	mAh	
82719	3	2000	20

- PL Reflektor diodowy z czujnikiem ruchu
- GB LED lamp with motion detector
- D Diodenscheinwerfer mit Bewegungsmelder
- RUS Светодиодный прожектор с датчиком движения
- CZ LED reflektor se snímačem pohybu
- RO Reflector diodă cu senzor de mișcare
- H Diódás reflektor mozgásérzékelővel
- E Reflector de diodos con sensor de movimiento

50W	6000 K
4000 lm	230V~50Hz
25000 h	IP54
10m	



SMD LED



No.	W	lumens	h	
82848	50	4000	25000	12

- PL Diodowa lampa bezprzewodowa
- GB Rechargeable work lamp
- D Led Werkstattlampe
- RUS Светодиодная беспроводная лампа
- CZ Montážní lampa diodová bezpřívodová
- RO Lampă cu led fara cablu
- H Ledlámpa
- E Lámpara inalámbrica de diodos

30 LED	120 lm	6000K	IP20	12V BATTERY CHARGER ŁADOWNIKA	230V~50Hz BATTERY CHARGER ŁADOWNIKA
3.7V 1200mAh Li-Ion	CHARGING TIME CZAS ŁADOWANIA 4.5 h	WORK TIME CZAS PRACY 3 h	HOOK HAK	MAGNETIC	



SMD LED



No.	LED	mAh	
82729	30	1200	6/12

- PL Diodowa lampa bezprzewodowa
- GB Rechargeable work lamp
- D Led Werkstattlampe
- RUS Светодиодная беспроводная лампа
- CZ Montážní lampa diodová bezpřívodová
- RO Lampă cu led fara cablu
- H Ledlámpa
- E Lámpara inalámbrica de diodos

36 LED	3.7V 1200mAh Li-Ion	230V~50Hz BATTERY CHARGER ŁADOWNIKA	12 V BATTERY CHARGER ŁADOWNIKA
CHARGING TIME CZAS ŁADOWANIA 4 h	WORK TIME CZAS PRACY 4 h	MAGNETIC	HOOK HAK



LED



No.	LED	mAh	
82720	36	500	10/20

- PL Lampa robocza LED
- GB LED work light
- D LED Handleuchte
- RUS Светодиодный светильник для мастерской
- CZ Ruční svítidla LED
- RO Lampa portabila cu LED
- H LED lámpa
- E Lámpara de taller LED



3W	100 lm
2 LIGHTING MODES TRYBY SVIETLENIA	WORK TIME CIAS PRACY 4 h
3.7V 800mAh Li-Ion	Micro USB
MAGNETIC	HOOK HAK

COB LED



2 tryby świecenia: 100%, 50%
przytrzymanie przycisku: światło czerwone, pulsowanie, sos

No.	W	lumens	h	
82723	3	100	4	12/48

- PL Lampa robocza LED
- GB LED work light
- D LED Werkstattlampe
- RUS Светодиодный светильник для мастерской
- CZ Ruční svítidla LED
- RO Lampa portabila cu LED
- H LED lámpa
- E Lámpara de taller LED

230V~50Hz	400 lm	24 LED
HOOK HAK	4.5 W	5.0m

SMD LED



No.	W	LED	
82706	4.5	24	10/20

- PL Lampa warsztatowa
- GB Work light
- D Werkstattlampe
- RUS Лампа-переноска
- CZ Pracovní lampa
- RO Lampă pt. atelier
- H Szerelőlámpa
- E Lámpara de taller

230V~50Hz	E 27	100 W	5.0m
-----------	------	-------	------



No.	W	type	
82713	100	„PRACTIC“	10

- PL Lampa warsztatowa
- GB Work light
- D Werkstattlampe
- RUS Лампа-переноска
- CZ Pracovní lampa
- RO Lampă pt. atelier
- H Szerelőlámpa
- E Lámpara de taller

230V~50Hz	E 27	60W	5.0m
-----------	------	-----	------



No.	W	type	
82712	60	„BASKET“	10

- PL Lampa robocza LED
- GB LED work light
- D LED Werkstattlampe
- RUS Светодиодный светильник для мастерской
- CZ Ruční svítidla LED
- RO Lampa portabila cu LED
- H LED lámpa
- E Lámpara de taller LED



SMD LED



230V~50Hz	280 lm	16 LED
HOOK HAK	3.2 W	5.0m

No.	W	LED	
82699	3.2	16	10/20

- PL Lampa warsztatowa
- GB Work light
- D Werkstattlampe
- RUS Лампа-переноска
- CZ Pracovní lampa
- RO Lampă pt. atelier
- H Szerelőlámpa
- E Lámpara de taller

230V~50Hz	TC-S G23	11W	5.0m
-----------	----------	-----	------



No.	W	type	
82705	11	„EFFECT“	10

- PL Lampa warsztatowa
- GB Work light
- D Werkstattlampe
- RUS Лампа-переноска
- CZ Pracovní lampa
- RO Lampă pt. atelier
- H Szerelőlámpa
- E Lámpara de taller

230V~50Hz	E 27	60W	5.0m
-----------	------	-----	------



No.	W	type	
82715	60	„PLASTIC“	10

- PL Lampa warsztatowa
- GB Work light
- D Werkstattlampe
- RUS Лампа-переноска
- CZ Pracovní lampa
- RO Lampă pt. atelier
- H Szerelőlámpa
- E Lámpara de taller

230V~50Hz	E 27	60W	5.0m
-----------	------	-----	------



No.	W	type	
82714	60	„CLASSIC“	10

PL Lampa warsztatowa CZ Pracovní lampa
GB Work light RO Lampă pt. atelier
D Werkstattlampe H Szerelőlámpa
RUS Лампа-переноска E Lámpara de taller



No.	W	type	☐
82716	60	„GUMMI“	10
82717	100	„GUMMI“	10

PL Lampa robocza LED
GB LED work light
D LED Handleuchte
RUS Светодиодный светильник для мастерской
CZ Ruční svítidla LED
RO Lampa portabilă cu LED
H LED lámpa
E Lámpara de taller LED

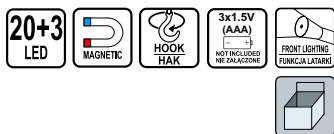

SMD
LED

VOREL

No.	LED	battery / bateria	☐
82730	20+3	3xAAA	12/48

PL Lampa robocza LED
GB LED work light
D LED Handleuchte
RUS Светодиодный светильник для мастерской
CZ Ruční svítidla LED
RO Lampa portabilă cu LED
H LED lámpa
E Lámpara de taller LED



COB
LED

VOREL

No.	battery / bateria	☐
82726	3xAA	12/48

PL Lampa robocza LED CZ Ruční svítidla LED
GB LED work light RO Lampa portabilă cu LED
D LED Handleuchte H LED lámpa
RUS Светодиодный светильник для мастерской E Lámpara de taller LED

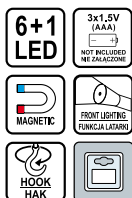

SMD
LED

VOREL

No.	LED	battery / bateria	☐
82742	6+1	3xAAA	12/48

PL Lampa robocza LED
GB LED work light
D LED Handleuchte
RUS Светодиодный светильник для мастерской
CZ Ruční svítidla LED
RO Lampa portabilă cu LED
H LED lámpa
E Lámpara de taller LED



COB
LED

VOREL

No.	battery / bateria	☐
82724	3xAAA	12/48

PL Lampa robocza LED
GB LED work light
D LED Handleuchte
RUS Светодиодный светильник для мастерской
CZ Ruční svítidla LED
RO Lampa portabilă cu LED
H LED lámpa
E Lámpara de taller LED



SMD
LED



VOREL

No.	LED	battery / bateria	☐
82731	24+3	3xAAA	12/48

PL Lampa robocza LED
GB LED work light
D LED Handleuchte
RUS Светодиодный светильник для мастерской
CZ Ruční svítidla LED
RO Lampa portabilă cu LED
H LED lámpa
E Lámpara de taller LED

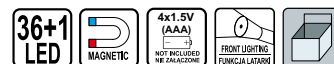

VOREL

No.	LED	battery / bateria	☐
82735	36+1	4xAAA	12/48

PL Chwytnak teleskopowy LED
GB LED magnetic pick up tool
D LED Magnet Heber
RUS Захват магнитный телескопический с подсветкой
CZ Patka magnetická teleskopická LED
RO Telescop magnetic cu LED
H LED fészédő mágnes teleszkópos nyéllel
E Herramienta para levantar, telescópica, con LED

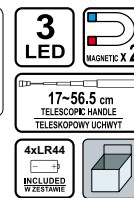
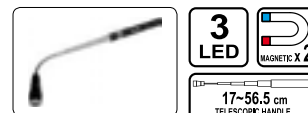

LED

VOREL

No.	LED	battery / bateria	☐
78405	3	3xAAA	12/48

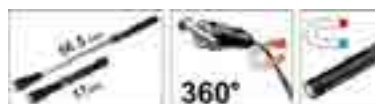

PL Zestaw latarka UV LED i okulary
 GB UV LED flashlight and glasses set
 D UV LED-Taschenlampe mit UV Schutzbrille
 RUS Комплект для проверки утечек хладагента - УФ фонарь 21-LED

CZ UV LED svítilna + brýle
 RO Set lanternă UV LED și ochelari
 H UV LED zseblámpa + szemüveg
 E UV LED linterna con gafas para



UV
LED



No.	LED	battery / bateria	📦
82756	21	3xAAA	80

PL Latarka LED
 GB LED Flashlight
 D LED-Taschenlampe
 RUS Светодиодный фонарь

CZ LED svítilna
 RO Lanterna cu LED
 H LED elemlámpa
 E Linterna LED

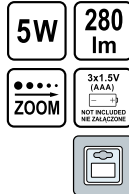

POWER
LED



No.	battery / bateria	📦
88555	3xAAA	12/48

PL Diodowa latarka czolowa
 GB Led work lamp
 D Stirntaschenlampe
 RUS Налобный светодиодный фонарь
 CZ Led montážní lampa - čelovka
 RO Lampa cu led
 H Led fejlámpa
 E Linterna de diodo



POWER
LED
XPE 3 W 130 lm

COB
LED
3 W 120 lm



No.	battery / bateria	📦
88678	3xAAA	6/24

PL Latarka LED
 GB LED Flashlight
 D LED-Taschenlampe
 RUS Светодиодный фонарь

CZ LED svítilna
 RO Lanterna cu LED
 H LED elemlámpa
 E Linterna LED

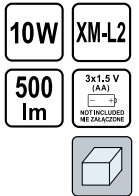

POWER
LED



No.	battery / bateria	📦
88560	3xAA	12/24

PL Latarka LED
 GB LED Flashlight
 D LED-Taschenlampe
 RUS Светодиодный фонарь

CZ LED svítilna
 RO Lanterna cu LED
 H LED elemlámpa
 E Linterna LED

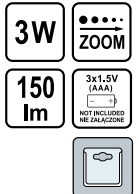

POWER
LED



No.	W	lumens	battery / bateria	📦
88550	3	150	3xAAA	12/48

PL Diodowa latarka czolowa
 GB Led work lamp
 D Stirntaschenlampe
 RUS Налобный светодиодный фонарь
 CZ Led montážní lampa - čelovka
 RO Lampa cu led
 H Led fejlámpa
 E Linterna de diodo



POWER
LED
XPE 3 W 130 lm

SMD
LED
4 LED 160 lm



No.	📦
88677	12/48

- PL Diodowa latarka czolowa
- GB Led work lamp
- D Stirntaschenlampe
- RUS Налобный светодиодный фонарь
- CZ Led montážní lampa - čelovka
- RO Lampa cu led
- H Led fejlámpa
- E Linterna de diodo



No.	battery / bateria	
88670	3xAAA	12/72

- PL Diodowa latarka czolowa
- GB Led work lamp
- D Stirntaschenlampe
- RUS Налобный светодиодный фонарь
- CZ Led montážní lampa - čelovka
- RO Lampa cu led
- H Led fejlámpa
- E Linterna de diodo



No.	battery / bateria	
88672	3xAAA	12/60

- PL Diodowa latarka czolowa
- GB Led work lamp
- D Stirntaschenlampe
- RUS Налобный светодиодный фонарь
- CZ Led montážní lampa - čelovka
- RO Lampa cu led
- H Led fejlámpa
- E Linterna de diodo

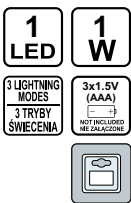

No.	battery / bateria	
88674	3xAAA	12/48

- PL Lampa czolowa LED
- GB LED headlamp
- D LED Kopflampe
- RUS Налобный светодиодный фонарь
- CZ Čelová lampa LED
- RO Lanterna cu LED pt. cap
- H LED fejlámpa
- E Lámpara LED de Cabeza



No.	battery / bateria	
88676	3xAAA	12/48

- PL Diodowa latarka czolowa
- GB Led work lamp
- D Stirntaschenlampe
- RUS Налобный светодиодный фонарь
- CZ Led montážní lampa - čelovka
- RO Lampa cu led
- H Led fejlámpa
- E Linterna de diodo



No.	battery / bateria	
88671	3xAAA	12/72

- PL Diodowa latarka czolowa
- GB Led work lamp
- D Stirntaschenlampe
- RUS Налобный светодиодный фонарь
- CZ Led montážní lampa - čelovka
- RO Lampa cu led
- H Led fejlámpa
- E Linterna de diodo

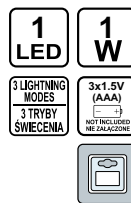

No.	battery / bateria	
88673	3xAAA	12/48

- PL Lampa czolowa LED
- GB LED headlamp
- D LED Kopflampe
- RUS Налобный светодиодный фонарь
- CZ Čelová lampa LED
- RO Lanterna cu LED pt. cap
- H LED fejlámpa
- E Lámpara LED de Cabeza

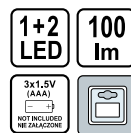

No.	battery / bateria	
88675	3xAAA	12/48

- PL Lampa rowerowa przednia LED
- GB LED front bike light
- D Fahrrad Frontscheinwerfer LED
- RUS Светодиодный фонарик для велосипеда
- CZ Přední světla LED na kolo
- RO Lanterna pt. bicicleta LED
- H LED-es első kerékpár lámpa
- E Linterna LED frontal para bicicleta

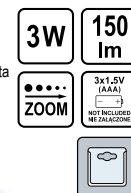

No.	battery / bateria	
88411	3xAAA	12/48

PL Zestaw lamp rowerowych LED
 GB LED bike light set
 D Fahrrad-Beleuchtungsset LED
 RUS Набор светодиодных велосипедных фонарей

CZ Set LED osvětlení na kolo
 RO Set lanterna bicicleta LED
 H LED kerékpár lámpa szett
 E Juego de luces LED para bicicleta

POWER LED



5 LED
 3W
 150 lm
 2x1.5V (AAA) NOT INCLUDED (NE SZÁLLASÍTOTT)
 3x1.5V (AAA) NOT INCLUDED (NE SZÁLLASÍTOTT)
 ZOOM

VOREL

No.	battery / bateria	
88422	3xAAA / 2xAAA	12/48

PL Czujnik ruchu
 GB Motion detector
 D Bewegungsfühler
 RUS Детектор движения

CZ Snímač pohybu
 RO Senzor de mișcare
 H Mozgásérzékelő
 E Sensor del movimiento



VOREL

No.		
83120		50

PL Czujnik ruchu
 GB Motion detector
 D Bewegungsfühler
 RUS Детектор движения

CZ Snímač pohybu
 RO Senzor de mișcare
 H Mozgásérzékelő
 E Sensor del movimiento



VOREL

No.		
83122		50

PL Czujnik ruchu
 GB Motion detector
 D Bewegungsfühler
 RUS Детектор движения

CZ Snímač pohybu
 RO Senzor de mișcare
 H Mozgásérzékelő
 E Sensor del movimiento



VOREL

No.		
83124		50

PL Zestaw lamp rowerowych LED
 GB LED bike light set
 D Fahrrad-Beleuchtungsset LED
 RUS Набор светодиодных велосипедных фонарей

CZ Set LED osvětlení na kolo
 RO Set lanterna bicicleta LED
 H LED kerékpár lámpa szett
 E Juego de luces LED para bicicleta

POWER LED



VOREL

No.	battery / bateria	
88421	3xAAA / 2xAAA	12/120

PL Czujnik ruchu
 GB Motion detector
 D Bewegungsfühler
 RUS Детектор движения

CZ Snímač pohybu
 RO Senzor de mișcare
 H Mozgásérzékelő
 E Sensor del movimiento



VOREL

No.		
83121		50

PL Czujnik ruchu
 GB Motion detector
 D Bewegungsfühler
 RUS Детектор движения

CZ Snímač pohybu
 RO Senzor de mișcare
 H Mozgásérzékelő
 E Sensor del movimiento



VOREL

No.		
83123		50

PL Czujnik ruchu
 GB Motion detector
 D Bewegungsfühler
 RUS Детектор движения

CZ Snímač pohybu
 RO Senzor de mișcare
 H Mozgásérzékelő
 E Sensor del movimiento



VOREL

No.		
83124		50

1W
 5 LED
 2x1.5V (AAA) NOT INCLUDED (NE SZÁLLASÍTOTT)
 3x1.5V (AAA) NOT INCLUDED (NE SZÁLLASÍTOTT)

220-240 V~
 50/60 Hz
 max. 1200 W
 max. 300 W
 IP44

220-240 V~
 50/60 Hz
 max. 1200 W
 max. 300 W
 IP44

220-240 V~
 50/60 Hz
 max. 1200 W
 max. 300 W
 IP20

23

Garden tools & power tools
Narzędzia i elektronarzędzia ogrodowe



Watering program Program wodny

338-351



Hose connectors, male connectors, couplings, hose menders
Złącza, nypły, łączniki, rozgałęziacze, reparatory..... 338

Water timers
Sterowniki nawadniania..... 342

Hose nozzles (sprinklers) & sets
Zraszacze i zestawy..... 342

Garden hoses
Wężę ogrodowe..... 348

Garden hose carts & holders
Wózki i stojaki na wężę ogrodowe..... 348

Pumps
Pompy..... 349

Pruners & shears Sekatory i nożyce ogrodowe

351-355



Pruners
Sekatory..... 351

Lopping shears
Sekatory do gałęzi..... 353

Leverage tree pruners
Sekatory gąsienicowe..... 354

Hedge shears
Nożyce do żywopłotu..... 354

Grass shears
Nożyce do trawy..... 355

Garden saws & blades Piły ogrodowe i brzeszczoty

355-356



Axes & splitting wedges Siekiry i kliny do drewna

356-358



Hand tools Narzędzia ręczne

358-372



Small garden tools
Małe narzędzia ogrodowe..... 358

Big garden tools
Duże narzędzia ogrodowe..... 361

Handles
Trzonki..... 370

Sprayers & accessories Opryskiwacze i akcesoria

372-375



Gasoline garden tools, power tools & accessories Ogrodowe narzędzia spalinowe, elektronarzędzia i akcesoria

375-379



Grass trimmers
Wykaszarki..... 375

Hedge trimmers
Nożyce do trawy i żywopłotu..... 375

Accessories
Akcesoria..... 377

Health & safety products Artykuły BHP

379-384



Gloves
Rękawice..... 379

Rain boots
Kalosze..... 380

Multipurpose trays
Podstawki gospodarcze..... 381

Knee pads
Nakolanniki..... 381

Head, hearing & eyesight protection
Ochrona głowy, słuchu i wzroku..... 382

Working clothes
Odzież robocza..... 384

Garden accessories Akcesoria ogrodowe

384-388



BBQ grills & accessories Grille i akcesoria

388-391



Gas BBQ grills
Grille gazowe..... 388

Charcoal BBQ grills
Grille węglowe..... 388

Fire pits
Paleniska ogrodowe..... 390

Accessories
Akcesoria..... 390

PL Złącze
GB Hose connector
D Universal
Schnellschlauchkupplung
RUS Соединитель

CZ Rychlospojka
RO Mufă pt. pistol
H Fitting
E Junta estandar

1/2"
12.5mm
3/4"
19mm

ABS



No.	size / rozmiar	packing	
89221	1/2" (12.5 mm)		150/600
89222	1/2" (12.5 mm)		24/288
89223	3/4" (19.0 mm)		60/240
89224	3/4" (19.0 mm)		24/288

PL Złącze
GB Hose connector
D Universal
Schnellschlauchkupplung
RUS Соединитель

CZ Rychlospojka
RO Mufă pt. pistol
H Fitting
E Junta estandar

1/2"
12.5mm
3/4"
19mm

ABS

STOP



No.	size / rozmiar	packing	
89225	1/2" (12.5 mm)		150/600
89226	1/2" (12.5 mm)		24/288
89227	3/4" (19.0 mm)		60/240
89228	3/4" (19.0 mm)		24/288

PL Złącze mosiężne
GB Brass hose connector
D Schlauch-Schnellkupplung
RUS Быстросъемная муфта

CZ Rychlospojka
RO Manșon de îmbinare
H Csatlakozó
E Conexión

1/2"
12.5mm
3/4"
19mm

BRASS
MOSIADZ



No.	size / rozmiar	
89100	1/2" (12.5 mm)	48
89102	3/4" (19.0 mm)	48

PL Złącze mosiężne stop
GB Brass hose connector
D Schlauch-Schnellkupplung
RUS Быстросъемная муфта

CZ Rychlospojka
RO Manșon de îmbinare
H Csatlakozó
E Conexión

1/2"
12.5mm
3/4"
19mm

BRASS
MOSIADZ

STOP



No.	size / rozmiar	
89101	1/2" (12.5 mm)	48
89103	3/4" (19.0 mm)	48

PL Złącze
GB Hose connector
D Universal
Schnellschlauchkupplung
RUS Соединитель

CZ Rychlospojka
RO Mufă pt. pistol
H Fitting
E Junta estandar

1/2"
12.5mm
3/4"
19mm

ABS



No.	size / rozmiar	
89001	1/2" (12.5 mm)	30/240
89002	3/4" (19.0 mm)	30/240

PL Złącze
GB Hose connector
D Universal
Schnellschlauchkupplung
RUS Соединитель

CZ Rychlospojka
RO Mufă pt. pistol
H Fitting
E Junta estandar

1/2"
12.5mm
3/4"
19mm

ABS

STOP



No.	size / rozmiar	
89003	1/2" (12.5 mm)	30/240
89004	3/4" (19.0 mm)	30/240

PL Złącze mosiężne
GB Brass hose connector
D Schlauch-Schnellkupplung
RUS Быстросъемная муфта

CZ Rychlospojka
RO Manșon de îmbinare
H Csatlakozó
E Conexión

1/2"
12.5mm
3/4"
19mm

BRASS
MOSIADZ



No.	size / rozmiar	
89070	1/2" (12.5 mm)	12/48
89072	3/4" (19.0 mm)	12/48

PL Złącze mosiężne stop
GB Brass hose connector
D Schlauch-Schnellkupplung
RUS Быстросъемная муфта

CZ Rychlospojka
RO Manșon de îmbinare
H Csatlakozó
E Conexión

1/2"
12.5mm
3/4"
19mm

BRASS
MOSIADZ

STOP



No.	size / rozmiar	
89071	1/2" (12.5 mm)	12/48
89073	3/4" (19.0 mm)	12/48

PL Reparatör do węzła
GB Hose mender
D Schlauchreparatur
RUS Соединитель шлангов

CZ Opravka
RO Mufă înădire
H Gyorstoldó
E Reparatör para manguera

1/2"
12.5mm
3/4"
19mm
ABS



No.	size / rozmiar	packing	
89229	1/2" (12.5 mm)		60/240
89230	1/2" (12.5 mm)		24/288
89231	3/4" (19.0 mm)		60/240
89232	3/4" (19.0 mm)		24/288

PL Reparatör do węzła
GB Hose mender
D Schlauchreparaturstück
RUS Соединитель шлангов

CZ Opravka
RO Mufă înădire
H Csatlakozó
E Reparatör para manguera

1/2"
12.5mm
3/4"
19mm
BRASS
MOSIADZ



No.	size / rozmiar	
89104	1/2" (12.5 mm)	48
89105	3/4" (19.0 mm)	48

PL Reparatör do węzła
GB Hose mender
D Schlauchverbinder mit Reduktion
RUS Соединитель шлангов

CZ Opravka
RO Mufă înădire
H Gyorstoldó
E Reparatör para manguera

1/2"
12.5mm
3/4"
19mm
ABS



No.	size / rozmiar	packing	
89233	3/4"; 1/2" (19.0; 12.5 mm)		60/240
89234	3/4"; 1/2" (19.0; 12.5 mm)		24/288

PL Przyłącze do kranu
GB Snap-in tap adaptor
D Wasserhahanschluß für Gartenschlauch
RUS Адаптер внешний

CZ Šroubení
RO Mufă pt. robinet cu filet interior
H Tömlovég csaphoz
E Tubuladura de grifo

1/2"
12.5mm
ABS



No.	size / rozmiar	
89253	1/2" (12.5 mm)	24/240

PL Reparatör do węzła
GB Hose mender
D Schlauchreparatur
RUS Соединитель шлангов

CZ Opravka
RO Mufă înădire
H Gyorstoldó
E Reparatör para manguera

1/2"
12.5mm
3/4"
19mm
ABS



No.	size / rozmiar	
89007	1/2" (12.5 mm)	30/240
89008	3/4" (19.0 mm)	30/240

PL Reparatör do węzła
GB Hose mender
D Schlauchreparaturstück
RUS Соединитель шлангов

CZ Opravka
RO Mufă înădire
H Csatlakozó
E Reparatör para manguera

1/2"
12.5mm
3/4"
19mm
BRASS
MOSIADZ



No.	size / rozmiar	
89074	1/2" (12.5 mm)	12/48
89075	3/4" (19.0 mm)	12/48

PL Reparatör do węzła
GB Hose mender
D Schlauchverbinder mit Reduktion
RUS Соединитель шлангов

CZ Opravka
RO Mufă înădire
H Gyorstoldó
E Reparatör para manguera

1/2"
12.5mm
3/4"
19mm
ABS



No.	size / rozmiar	
89011	1/2"; 3/4" (12.5; 19.0 mm)	30/240

PL Nypel
GB Male connector
D Anschlussgerätestück
RUS Адаптер внутренний

CZ Spojka
RO Mufă pt. robinet cu filet exterior
H Kúlsó menetesítő
E Nypel

3/4"
19mm
ABS



No.	size / rozmiar	packing	
89239	3/4" (19.0 mm)		250/1000
89240	3/4" (19.0 mm)		24/288

PL Przyłącze do kranu
GB Snap-in tap adaptor
D Wasserhahnanschluss für Gartenschlauch
RUS Адаптер внешний

CZ Šroubení
RO Mufă pt. robinet cu filet interior
H Tömlovég csaphoz
E Tubuladura de grifo

3/4"
19mm

ABS



No.	size / rozmiar	
89015	3/4" (19.0 mm)	30/240

PL Przyłącze do kranu
GB Snap-in tap adaptor
D Wasserhahnanschluss für Gartenschlauch
RUS Адаптер внешний

CZ Šroubení
RO Mufă pt. robinet cu filet interior
H Tömlovég csaphoz
E Tubuladura de grifo

3/4"
19mm

BRASS
MOSIADZ



No.	size / rozmiar	
89080	3/4" (19.0 mm)	12/48

PL Przyłącze do kranu
GB Snap-in tap adaptor
D Wasserhahnanschluss für Gartenschlauch
RUS Адаптер внешний

CZ Šroubení
RO Mufă pt. robinet cu filet interior
H Tömlovég csaphoz
E Tubuladura de grifo

3/4"
19mm

ABS



No.	size / rozmiar	
89013	3/4" (19.0 mm)	30/240

PL Przyłącze do kranu
GB Snap-in tap adaptor
D Wasserhahnanschluss für Gartenschlauch
RUS Адаптер для крана

CZ Šroubení
RO Mufă pt. robinet cu filet interior
H Tömlovég csaphoz
E Tubuladura de grifo

3/4"
19mm

1"
25mm

BRASS
MOSIADZ



No.	size / rozmiar	
89076	3/4" (19.0 mm)	12/48
89077	1" (25.0 mm)	12/48

PL Nypel
GB Male connector
D Anschlussgerätestück
RUS Адаптер внутренний

CZ Spojka
RO Mufă pt. robinet cu filet exterior
H Kúlsó menetestölvég
E Nypel

3/4"
19mm

BRASS
MOSIADZ



No.	size / rozmiar	
89110	3/4" (19.0 mm)	48

PL Przyłącze do kranu
GB Snap-in tap adaptor
D Wasserhahnanschluss für Gartenschlauch
RUS Адаптер для крана

CZ Šroubení
RO Mufă pt. robinet cu filet interior
H Tömlovég csaphoz
E Tubuladura de grifo

3/4"
19mm

ABS



No.	size / rozmiar	packing	
89235	3/4" (19.0 mm)		250/1000
89236	3/4" (19.0 mm)		24/288

PL Przyłącze do kranu
GB Snap-in tap adaptor
D Wasserhahnanschluss für Gartenschlauch
RUS Адаптер для крана

CZ Šroubení
RO Mufă pt. robinet cu filet interior
H Tömlovég csaphoz
E Tubuladura de grifo

3/4"
19mm

1"
25mm

BRASS
MOSIADZ



No.	size / rozmiar	
89106	3/4" (19.0 mm)	48
89107	1" (25.0 mm)	48

PL Przyłącze do kranu
GB Snap-in tap adaptor
D Wasserhahnanschluss für Gartenschlauch
RUS Адаптер для крана

CZ Šroubení
RO Mufă pt. robinet cu filet interior
H Tömlovég csaphoz
E Tubuladura de grifo

1/2"
12.5mm

3/4"
19mm

1"
25mm

ABS



No.	size / rozmiar	packing	
89241	1/2": 3/4" (12.5; 19.0 mm)		250/1000
89242	1/2": 3/4" (12.5; 19.0 mm)		24/288
89251	3/4": 1" (19.0; 25.0 mm)		100/1000
89252	3/4": 1" (19.0; 25.0 mm)		24/288

PL Przyłącze do kranu
GB Snap-in tap adaptor
D Wasserhahnanschluss für Gartenschlauch
RUS Адаптер для крана

CZ Šroubení
RO Mufă pt. robinet cu filet interior
H Tömlovég csaphoz
E Tubuladura de grifo



No.	size / rozmiar	
89017	1/2"; 3/4" (12.5; 19.0 mm)	30/240
89018	3/4"; 1" (19.0; 25.0 mm)	30/240

PL Przyłącze do kranu
GB Snap-in tap adaptor
D Wasserhahnanschluss für Gartenschlauch
RUS Адаптер для крана

CZ Šroubení
RO Mufă pt. robinet cu filet interior
H Tömlovég csaphoz
E Tubuladura de grifo



No.	size / rozmiar	
89078	1/2"; 3/4" (12.5; 19.0 mm)	12/48
89079	3/4"; 1" (19.0; 25.0 mm)	12/48

PL Złącze typu „I”
GB 2 way coupling
D Doppelkupplung
RUS Переходник

CZ Spojka
RO Prelungitor furtun apă
H „I” típusú csötöldő idom
E Junta tipo „I”



No.		
89020		30/240

PL Złącze typu „I”
GB 2 way coupling
D Doppelkupplung
RUS Переходник

CZ Spojka
RO Prelungitor furtun apă
H „I” típusú csötöldő idom
E Junta tipo „I”



No.		
89083		12/48

PL Przyłącze do kranu
GB Snap-in tap adaptor
D Wasserhahnanschluss für Gartenschlauch
RUS Адаптер для крана

CZ Šroubení
RO Mufă pt. robinet cu filet interior
H Tömlovég csaphoz
E Tubuladura de grifo

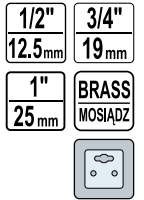

No.	size / rozmiar	
89108	1/2"; 3/4" (12.5; 19.0 mm)	48
89109	3/4"; 1" (19.0; 25.0 mm)	48

PL Złącze typu „I”
GB 2 way coupling
D Doppelkupplung
RUS Соединитель шлангов

CZ Spojka
RO Prelungitor furtun apă
H „I” típusú csötöldő idom
E Junta tipo „I”



No.	size / rozmiar	packing	
89245	1/2" (12.5 mm)		125/500
89246	1/2" (12.5 mm)		24/288

PL Złącze typu „I”
GB 2 way coupling
D Doppelkupplung
RUS Переходник

CZ Spojka
RO Prelungitor furtun apă
H „I” típusú csötöldő idom
E Junta tipo „I”



No.	size / rozmiar	
89113	1/2" (12.5 mm)	48

PL Rozdzielacz typu „Y”
GB 3 way coupling
D Drei Wege Kupplung
RUS Тройник для шлангов

CZ Y-kus
RO Distribuitor 3 căi
H „Y” típusú elágazás
E Distribuitor tipo „Y”



No.		packing	
89243			125/250
89244			24/288

PL Rozdzielacz typu „Y”
GB 3 way coupling
D Drei Wege Kupplung
RUS Тройник для шлангов

CZ Y-kus
RO Distributor 3 cai
H „Y” tipusú elágazás
E Distribuidor tipo „Y”

1/2"
12.5mm

BRASS
MOSIADZ



No.	size / rozmiar	48
89112	1/2" (12.5 mm)	48

PL Rozdzielacz z zaworami
GB Y-switch coupling with swivel
D 2-Wege Ventil
RUS Распределитель внешний

CZ Rozbočovač s uzavíracími ventily
RO Racord iny cu robinet
H Y-elágazó, 2 db külső menetes elzáróval
E Distribuidor tipo „Y”

1/2"
12.5mm

3/4"
19mm

ABS



No.	size / rozmiar	12/120
89022	1/2": 3/4" (12.5; 19.0 mm)	12/120

PL Czasowy wyłącznik przepływu wody
GB Water timer
D Bewässerungsuhr
RUS Таймер для управления подачей воды

CZ Zavlažovací hodiny
RO Programator automat
H Vizprogramozó óra
E Programador manual para tubos de agua

3/4"
19mm

1"
25mm



No.	size / rozmiar	6/24
89282	3/4": 1" (19.0; 25.0 mm)	6/24

PL Zraszacz prosty regulowany
GB Adjustable spray nozzle
D Spritze
RUS Распылитель поливочный

CZ Postřikovač
RO Stropitor apă
H Szórófej
E Rociador

ABS



No.	25/150
89200	25/150

PL Rozdzielacz z zaworami
GB Y-switch coupling with swivel
D 2-Wege Ventil
RUS Распределитель внешний

CZ Rozbočovač s uzavíracími ventily
RO Racord iny cu robinet
H Y-elágazó, 2 db külső menetes elzáróval
E Distribuidor tipo „Y”

3/4"
19mm



No.	size / rozmiar	packing	24/240
89247	3/4" (19.0 mm)		24/240
89248	3/4" (19.0 mm)		12/96

PL Czasowy wyłącznik przepływu wody
GB Water timer
D Bewässerungsuhr
RUS Таймер для управления подачей воды

CZ Zavlažovací hodiny
RO Programator automat
H Vizprogramozó óra
E Programador manual para tubos de agua

3/4"
19mm

1"
25mm



No.	size / rozmiar	24
89281	3/4": 1" (19.0; 25.0 mm)	24

PL Zraszacz prosty regulowany
GB Adjustable spray nozzle
D Spritze
RUS Распылитель поливочный

CZ Postřikovač
RO Stropitor apă
H Szórófej
E Rociador

ABS



No.	packing	25/100
89201		25/100
89202		12/120

PL Zraszacz prosty regulowany
GB Adjustable spray nozzle
D Spritze
RUS Распылитель поливочный

CZ Postřikovač
RO Stropitor apă
H Szórófej
E Rociador

ABS



No.	48
89187	48

PL Zraszacz prosty
GB Straight nozzle
D Spritze
RUS Распылитель поливочный

CZ Postřikovač
RO Stropitor apă
H Szórófej
E Rociador simple



No.	size / rozmiar	box
89120	1/2" (12.5 mm)	48

PL Pistolet zraszający regulowany
GB Adjustable spray gun
D Regelbare Sprühpistole
RUS Регулируемый оросительный пистолет

CZ Kropící pistole regulovatelná
RO Pistolet de irigare ajustabil
H Öntöző pisztoly, állítható sugarú
E Pistola rociadora ajustable

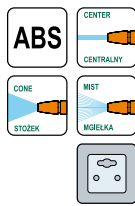

No.	box
89210	12/48

PL Pistolet zraszający regulowany
GB Adjustable spray gun
D Regelbare Sprühpistole
RUS Регулируемый оросительный пистолет

CZ Kropící pistole regulovatelná
RO Pistolet de irigare ajustabil
H Öntöző pisztoly, állítható sugarú
E Pistola rociadora ajustable

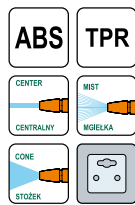

No.	box
89214	12/48

PL Pistolet zraszający regulowany
GB Adjustable spray gun
D Regelbare Sprühpistole
RUS Регулируемый оросительный пистолет

CZ Kropící pistole regulovatelná
RO Pistolet de irigare ajustabil
H Öntöző pisztoly, állítható sugarú
E Pistola rociadora ajustable



No.	box
89193	12/48

PL Zraszacz prosty regulowany
GB Adjustable spray nozzle
D Spritze
RUS Распылитель поливочный

CZ Postřikovač
RO Stropitor apă
H Szórófej
E Rociador

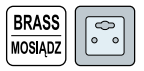

No.	box
89090	12/48

PL Pistolet zraszający regulowany
GB Adjustable spray gun
D Regelbare Sprühpistole
RUS Регулируемый оросительный пистолет

CZ Kropící pistole regulovatelná
RO Pistolet de irigare ajustabil
H Öntöző pisztoly, állítható sugarú
E Pistola rociadora ajustable

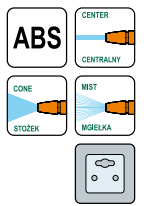

No.	box
89213	12/48

PL Pistolet zraszający regulowany
GB Adjustable spray gun
D Regelbare Sprühpistole
RUS Регулируемый оросительный пистолет

CZ Kropící pistole regulovatelná
RO Pistolet de irigare ajustabil
H Öntöző pisztoly, állítható sugarú
E Pistola rociadora ajustable



No.	box
89189	12/48

PL Pistolet zraszający regulowany
GB Adjustable spray gun
D Regelbare Sprühpistole
RUS Регулируемый оросительный пистолет

CZ Kropící pistole regulovatelná
RO Pistolet de irigare ajustabil
H Öntöző pisztoly, állítható sugarú
E Pistola rociadora ajustable

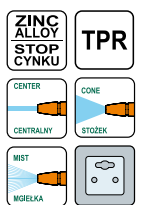

No.	box
89194	6/24

PL Pistolet zraszający regulowany
 GB Adjustable spray gun
 D Regelbare Sprühpistole
 RUS Регулируемый оросительный пистолет

CZ Kropící pistole regulovatelná
 RO Pistolet de irigare ajustabil
 H Öntöző pisztoly, állítható sugarú
 E Pistola rociadora ajustable

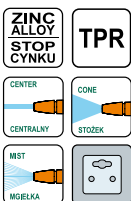

No. 89190  12/48

PL Pistolet zraszający regulowany
 GB Adjustable spray gun
 D Regelbare Sprühpistole
 RUS Регулируемый оросительный пистолет

CZ Kropící pistole regulovatelná
 RO Pistolet de irigare ajustabil
 H Öntöző pisztoly, állítható sugarú
 E Pistola rociadora ajustable

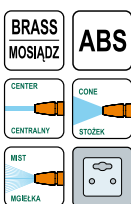

No. 89215  12/24

PL Wielofunkcyjny pistolet zraszający
 GB Multifunction sprinkling gun
 D Multifunktions-Spritzpistole
 RUS Многофункциональный оросительный пистолет

CZ Multifunkční postřikovací pistole
 RO Pistol multifuncțional pt. pulverizare
 H Többfunkciós öntöző pisztoly
 E Pistola para regar multifuncional

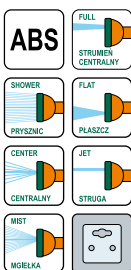

No. 89220  12/48

PL Wielofunkcyjny pistolet zraszający
 GB Multifunction sprinkling gun
 D Multifunktions-Spritzpistole
 RUS Многофункциональный оросительный пистолет
 CZ Multifunkční postřikovací pistole
 RO Pistol multifuncțional pt. pulverizare
 H Többfunkciós öntöző pisztoly
 E Pistola para regar multifuncional



No. 89192  12/48

PL Pistolet zraszający regulowany
 GB Adjustable spray gun
 D Regelbare Sprühpistole
 RUS Регулируемый оросительный пистолет

CZ Kropící pistole regulovatelná
 RO Pistolet de irigare ajustabil
 H Öntöző pisztoly, állítható sugarú
 E Pistola rociadora ajustable



No. 89180  12/48

PL Pistolet zraszający
 GB Sprinkling gun
 D Spritzpistole
 RUS Оросительный пистолет

CZ Postřikovací pistole
 RO Pistol pt. pulverizare
 H Öntöző pisztoly
 E Pistola para regar



No. 89209  12/48

PL Wielofunkcyjny pistolet zraszający
 GB Multifunction sprinkling gun
 D Multifunktions-Spritzpistole
 RUS Многофункциональный оросительный пистолет

CZ Multifunkční postřikovací pistole
 RO Pistol multifuncțional pt. pulverizare
 H Többfunkciós öntöző pisztoly
 E Pistola para regar multifuncional

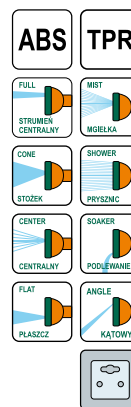

No. 89211  12/48

PL Wielofunkcyjny pistolet zraszający
 GB Multifunction sprinkling gun
 D Multifunktions-Spritzpistole
 RUS Многофункциональный оросительный пистолет

CZ Multifunkční postřikovací pistole
 RO Pistol multifuncțional pt. pulverizare
 H Többfunkciós öntöző pisztoly
 E Pistola para regar multifuncional

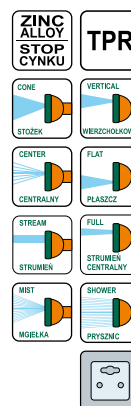

No. 89195  6/24

PL Wielofunkcyjny pistolet zraszający
 GB Multifunction sprinkling gun
 D Multifunktions-Spritzpistole
 RUS Многофункциональный оросительный пистолет

CZ Multifunkční postřikovací pistole
 RO Pistol multifuncțional pt. pulverizare
 H Többfunkciós öntöző pisztoly
 E Pistola para regar multifuncional



No.	
89191	12/48

PL Zestaw złączek ze zraszaczem prostym
 GB Basic hose set with straight nozzle
 D Bewässerungs Spritz und Anschlussset
 RUS Набор поливочный

CZ Postřikovač + spojky
 RO Ștut furtun apă cu accesorii pt. robinet
 H Készlet gyorskapoccsal csaphoz
 E Juego de rociar tubuladura de grifo

4 PCS

1/2" 12.5mm

3/4" 19mm

1" 25mm

ABS



No.	size / rozmiar	pcs	
89203	3/4"; 1" (19.0; 25.0 mm)	4	12/72
89204	1/2"; 3/4" (12.5; 19.0 mm)	4	12/72

PL Zestaw złączek ze zraszaczem pistoletowym
 GB Basic hose set with adjustable spray gun
 D Spritzbrause und Anschlussset
 RUS Набор поливочный

CZ Rozprašovací pistole na vodu + spojky
 RO Pistol reglabil cu și accesorii
 H Résztes készlet – os tömlőhöz
 E Juego de rociar para manguera

4 PCS

ABS

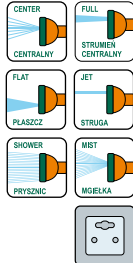

No.	size / rozmiar	pcs	
89206	1/2" (12.5 mm)	4	12/48

PL Zestaw złączek ze zraszaczem pistoletowym
 GB Basic hose set with adjustable spray gun
 D Spritzbrause und Anschlussset
 RUS Набор поливочный

CZ Rozprašovací pistole na vodu + spojky
 RO Pistol reglabil cu și accesorii
 H Résztes készlet – os tömlőhöz
 E Juego de rociar para manguera

4 PCS

ABS

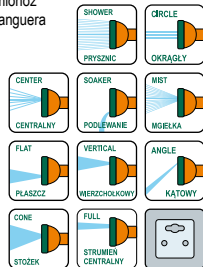

No.	size / rozmiar	pcs	
89208	1/2" (12.5 mm)	4	12/48

PL Wielofunkcyjny pistolet zraszający
 GB Multifunction sprinkling gun
 D Multifunktions-Spritzpistole
 RUS Многофункциональный оросительный пистолет

CZ Multifunkční postřikovací pistole
 RO Pistol multifuncțional pt. pulverizare
 H Többfunkciós öntöző pisztoly
 E Pistola para regar multifuncional

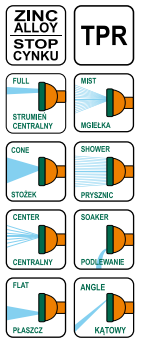

No.	
89181	12/48

PL Zestaw złączek ze zraszaczem prostym
 GB Basic hose set with straight nozzle
 D Bewässerungs Spritz und Anschlussset
 RUS Набор поливочный

CZ Postřikovač + spojky
 RO Ștut furtun apă cu accesorii pt. robinet
 H Készlet gyorskapoccsal csaphoz
 E Juego de rociar tubuladura de grifo

4 PCS

1/2" 12.5mm

3/4" 19mm

1" 25mm

ABS



No.	size / rozmiar	
89256	1/2"; 3/4" (12.5; 19.0 mm)	12/48
89255	3/4"; 1" (19.0; 25.0 mm)	12/48

PL Zestaw złączek ze zraszaczem pistoletowym
 GB Basic hose set with adjustable spray gun
 D Spritzbrause und Anschlussset
 RUS Набор поливочный

CZ Rozprašovací pistole na vodu + spojky
 RO Pistol reglabil cu și accesorii
 H Résztes készlet – os tömlőhöz
 E Juego de rociar para manguera

4 PCS

ABS

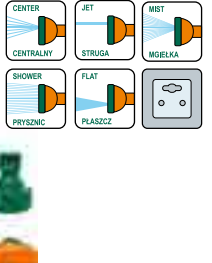

No.	size / rozmiar	pcs	
89207	1/2"; 3/4" (12.5; 19.0 mm)	4	12/48

PL Wąż spiralny z pistoletem zraszającym
 GB Coil hose set with spray gun
 D Spiralschlauch mit Multifunktionsbrause
 RUS Спиральный шланг в наборе с пистолетом

CZ Pištoľ striekacia s vinutou hadicou
 RO Furtun în spirală cu pistol pt. stropit
 H Locsoló pisztoly tömlővel
 E Manguera espiral con rociador

15m

COIL HOSE SPIRALNY WĄZ

EVA

CONE, STOEK, STRUMEN, ANGLE, KATOWY



No.	L (m)	
89351	15	8

- PL Lanca zraszająca wielofunkcyjna
- GB Sprinkling lance
- D Multifunktions-Spritzstab
- RUS Пика для распылителя многофункциональная
- CZ Multifunkční postřikovací nástavec
- RO Tijă pt. irigare
- H Többfunkciós esőztető fej
- E Lanza para regar multifuncional

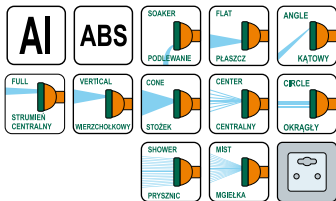

No.	
89218	12

- PL Zestaw uszczelek
- GB Set of gaskets
- D Dichtungssatz
- RUS Набор прокладок
- CZ Sada těsnění
- RO Set de garnituri
- H Tömítéskészlet esőztetőhöz
- E Juego de juntas

14
PCS



No.	pcs	for / dla	
89270	14	89100-89267	20/80

- PL Zraszacz 3-ramienny
- GB 3-arms revolving sprinkler
- D 3-Arm Kreis-Regner
- RUS Трехсторонний вращающийся распылитель на пике
- CZ Rozprašovač třiramenný
- RO Aspersol cu 3 brate
- H Locsoló, leszűrhető, forgó
- E Rociador 3-brazos



ABS



No.	
89272	12/48

- PL Zraszacz 3-ramienny
- GB 3-arm revolving sprinkler with spike
- D 3-arm Kreis-Regner
- RUS Трехсторонний вращающийся распылитель на пике
- CZ Rozprašovač třiramenný
- RO Aspersol cu 3 brate
- H Locsoló, leszűrhető, forgó
- E Rociador 3-brazos



ZINC ALLOY SPIKE
KÖLEC ZE STOPU CYNKU



No.	
89263	12/48

- PL Pysznic ogrodowy
- GB Garden shower
- D Gartendusche
- RUS Распылитель садовый
- CZ Zahradní sprcha
- RO Duș pt. grădină
- H Kerti zuhany
- E Regadera para jardín

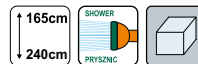

No.	
89390	6

- PL Zraszacz 3-ramienny
- GB 3-arms revolving sprinkler
- D 3-Arm Kreis-Regner
- RUS Трехсторонний вращающийся распылитель на пике
- CZ Rozprašovač třiramenný
- RO Aspersol cu 3 brate
- H Locsoló, leszűrhető, forgó
- E Rociador 3-brazos



ABS



No.	
89262	12/48

- PL Zraszacz impulsowy
- GB Impulse sprinkler
- D Impulsregner
- RUS Распылитель импульсный на пике
- CZ Postřikovač
- RO Stropitor apă
- H Impulzus szórófej
- E Rociador



ABS



No.	
89261	12/48

- PL Zraszacz impulsowy
 GB Impulse sprinkler
 D Impulsregner
 RUS Распылитель импульсный на пике
 CZ Postřikovač
 RO Stropitor apă
 H Impulzus szórófej
 E Rociador

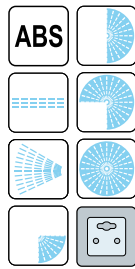

- PL Zraszacz impulsowy
 GB Impulse sprinkler
 D Impulsregner
 RUS Распылитель импульсный на пике
 CZ Postřikovač
 RO Stropitor apă
 H Impulzus szórófej
 E Rociador

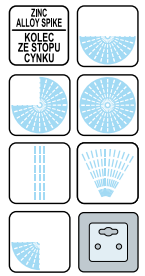

No.
89269

12/48



No.
89260

12/48

- PL Zraszacz 3-ramienny naziemny
 GB 3-arms revolving sprinkler on base
 D 3-Arm Kreis-Regner
 RUS Трехсторонний вращающийся распылитель на подставке
- CZ Rozprašováč třiramenný
 RO Aspersol cu 3 brate
 H Locsoló, leszúrható, forgó
 E Rociador 3-brazos



- PL Zraszacz 8-funkcyjny
 GB 8 pattern sprinkler
 D 8-Flächenregner
 RUS Распылитель 8-позиционный на подставке
 CZ Postřikovač
 RO Stropitor apă cu 8 duze
 H 8 funkciós szórófej
 E Rociador 8-funciones de tierra

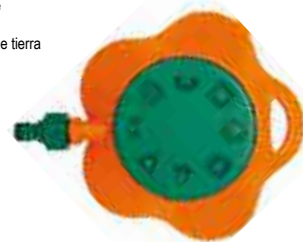

No.
89267

24



No.
89265

24/48

- PL Zraszacz 8-funkcyjny
 GB 8 pattern sprinkler
 D 8-Flächenregner
 RUS Распылитель 8-позиционный на подставке
 CZ Postřikovač
 RO Stropitor apă cu 8 duze
 H 8 funkciós szórófej
 E Rociador 8-funciones de tierra



- PL Zraszacz impulsowy naziemny
 GB Impulse sprinkler with base
 D Impulsregner
 RUS Распылитель импульсный
 CZ Postřikovač
 RO Stropitor apă
 H Impulzus szórófej
 E Rociador

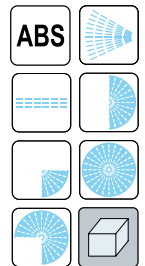

No.
89273

6/36



No.
89268

24

- PL Zraszacz impulsowy naziemny
 GB Impulse sprinkler with base
 D Impulsregner
 RUS Распылитель импульсный
 CZ Postřikovač
 RO Stropitor apă
 H Impulzus szórófej
 E Rociador

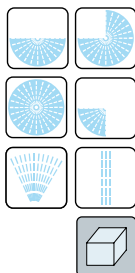

- PL Zraszacz "Szalona stokrotka"
 GB Garden sprayer „Crazy Daisy”
 D Garten Sprinkler
 RUS Распылитель
 CZ Sprcha zahradní
 RO Stropitor
 H Kerti locsoló
 E Rociador



No.
89266

24



No.
89351

12

- PL Zraszacz wyrzalny
GB Impulse pop-up sprinkler
D Tauchimpulsstrinkler
RUS Дождеватель выдвигной
- CZ Zavlažovač výsuvný
RO Aspersor cu impuls
H Esőztető szórófej
E Rociador de emerjer



No.	12
89280	12

- PL Wąż ogrodniczy
GB Garden hose
D Gartenschlauch
RUS Садовый шланг
- CZ Zahradní hadice
RO Furtun de gradina
H Kerti tömlő
E Manguera de jardín

ALGAE SETTLING PROOF
ODPORNOŚĆ NA OSADZANIE SIĘ GLONÓW

25 bar
BURSTING PRESSURE
CIŚNIENIE ROZRYWAJĄCE

UV PROOF
ODPORNOŚĆ NA PROMIENIOWANIE UV

TEMPERATURE TOLERANCE
ODPORNOŚĆ NA TEMPERATURĘ
-5°C ÷ +50°C



No.	L (m)	Ø	1
89311	20	1/2" (12.5 mm)	1
89312	30	1/2" (12.5 mm)	1
89313	50	1/2" (12.5 mm)	1
89314	20	3/4" (19.0 mm)	1
89315	30	3/4" (19.0 mm)	1
89316	50	3/4" (19.0 mm)	1
89318	20	1" (25.0 mm)	1
89319	30	1" (25.0 mm)	1
89320	50	1" (25.0 mm)	1

- PL Opaska ślimakowa do węża
GB Hose clip
D Schlauchklemme
RUS Хомут стальной
- CZ Šneková páska
RO Colier metalic
H Csigapánt
E Abrazadora



No.	Ø (mm)	for hose / do węża Ø	pcs	10/20
73506	12-20	1/2" (12.5 mm)	4	20
73507	16-25	3/4" (19.0 mm)	4	10/20
73508	20-32	1" (25.0 mm)	4	20
73510	12-20	1/2" (12.5 mm)	4	20
	16-25	3/4" (19.0 mm)	4	20
73511	16-25	3/4" (19.0 mm)	4	20
	20-32	1" (25.0 mm)	4	20

- PL Wąż ogrodniczy
GB Garden hose
D Gartenschlauch
RUS Садовый шланг
- CZ Zahradní hadice
RO Furtun de gradina
H Kerti tömlő
E Manguera de jardín

8 bar

15 bar
BURSTING PRESSURE
CIŚNIENIE ROZRYWAJĄCE

TEMPERATURE TOLERANCE
ODPORNOŚĆ NA TEMPERATURĘ
-5°C ÷ +50°C

UV PROOF
ODPORNOŚĆ NA PROMIENIOWANIE UV



No.	L (m)	Ø	1
89302	20	1/2" (12.5 mm)	1
89303	30	1/2" (12.5 mm)	1
89305	50	1/2" (12.5 mm)	1
89307	20	3/4" (19.0 mm)	1
89308	30	3/4" (19.0 mm)	1
89310	50	3/4" (19.0 mm)	1
89298	20	1" (25.0 mm)	1
89299	30	1" (25.0 mm)	1
89300	50	1" (25.0 mm)	1

- PL Wąż odpływowy do pomp
GB Pump drain hose
D Abflussschlauch für die Pumpen
RUS Сливной шланг для насосов
- CZ Výtlučná hadice pro čerpadla
RO Furtun de evacuare pt. pompe
H Eifolyó tömlő szivattyúhoz
E Manguera de salida para bombas



No.	L (m)	Ø	wall thickness / grosbość ścianki	15
79960	10	1" (25 mm)	1.2	15
79962	20	1" (25 mm)	1.2	8
79963	30	1" (25 mm)	1.2	6
79965	50	1" (25 mm)	1.2	3
79968	20	5/4" (32 mm)	1.4	6
79971	50	5/4" (32 mm)	1.4	3
79973	20	3/2" (38 mm)	1.8	4
79975	50	3/2" (38 mm)	1.8	2

- PL Stojak do węża ogrodowego
GB Hose holder
D Gartenschlauchträger
RUS Барабан для намотки поливочного шланга
- CZ Stojan navjeici na zahradní hadici
RO Suport pt. furtun
H Utartódob locsolótömlőkhöz
E Estante para manguera de jardín

PP

5/8" 30m
Ø (16.0 mm)

1/2" 45m
Ø (12.5 mm)

89330

5/8" 45m
Ø (16.0 mm)

1/2" 60m
Ø (12.5 mm)

89331



No.	size / rozmiar	5
89330	5/8" (16.0 mm) / 30m; 1/2" (12.5 mm) / 45m	5
89331	5/8" (16.0 mm) / 45m; 1/2" (12.5 mm) / 60m	5

- PL Wózek do węża ogrodowego
 GB Hose cart
 D Gartenschlauchwagen
 RUS Барабан для намотки поливочного шланга
 CZ Stojan navijeci na zahradní hadici
 RO Suport pt. furtun
 H Utartódob locsolótömlőhöz
 E Carretilla para manguera de jardín



∅ 5/8"	∅ (16.0 mm)	30m	30m
∅ 1/2"	∅ (12.5 mm)	45m	45m
∅ 5/8"	∅ (16.0 mm)	45m	45m
∅ 1/2"	∅ (12.5 mm)	60m	60m

89335

89336



No.	size / rozmiar	Icon
89335	5/8" (16.0 mm) / 30m; 1/2" (12.5 mm) / 45m	5
89336	5/8" (16.0 mm) / 45m; 1/2" (12.5 mm) / 60m	5

- PL Wieszak na wąż ogrodowy
 GB Hose hanger
 D Gartenschlauchträger
 RUS Кронштейн настенный для шланга
- CZ Věšák na hadici zahradní
 RO Suport de perete pt. furtun
 H Kertitömlő-akasztó
 E Colgador para manguera de jardín



No.	Icon
89345	60

- PL Podstawa pod pompę
 GB Pump base
 D Pumpenständer
 RUS Подставка для насоса
 CZ Podstavec pumpy
 RO Suport pt. pompa
 H Szivattyútalp
 E Soporte para bomba



No.	for / dla	Icon
89553	89552	1

- PL Zestaw do podlewania
 GB Watering set
 D Bewässerung Satz
 RUS Набор для полива
 CZ Zalévání kit
 RO Kit de udare
 H Locsoló készlet
 E Set de riego con manguera

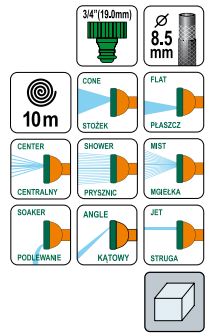

No.	L (m)	Icon
89342	10	8

- PL Pompa ręczna
 GB Hand pump
 D Schwengelpumpe
 RUS Насос ручной
- CZ Pumpa ruční
 RO Pompa manuală
 H Kézi szivattyú
 E Bomba de mano



No.	Icon
89552	1

- PL Pompa zatapialna do wody brudnej
 GB Dirty water submersible pump
 D Tauchmotorpumpe
 RUS Погружной насос
 CZ Zatavovací čerpadlo
 RO Pompă pt. apă murdară
 H Búvárszivattyú
 E Bomba de inmersión para agua sucia

230V~50Hz	1" 25mm	5/4" 32mm	1.5" 38mm	Icon
-----------	---------	-----------	-----------	------



No.	W	l / h	H (max)	Icon
79781	400	8000	5.5	4
79782	500	10000	6.5	4
79783	600	11500	7.0	4

- PL Pompa zatapialna do wody brudnej
 GB Dirty water submersible pump
 D Tauchmotorpumpe
 RUS Погружной насос
 CZ Zátavovací čerpadlo
 RO Pompă pt. apă murdară
 H Búvárszivattyú
 E Bomba de inmersión para agua sucia

230V~
50Hz

1"
25mm

5/4"
32mm

1.5"
38mm



FLO

No.	W	l / h	H (max)	Icon
79771	400	10000	6.5	4
79772	550	11500	7.0	4
79773	750	14000	7.5	4
79774	900	16000	8.5	4
79775	1100	16000	8.5	4

- PL Pompa membranowa zatapialna
 GB Membrane deep well water pump
 D Tauchmotorpumpe
 RUS Погружной насос
 CZ Zátavovací čerpadlo
 RO Pompă pt. apă cu membrană
 H Búvárszivattyú
 E Bomba de diafragma sumergible

220-230V
~50Hz

Q max
1020 l/h

280
W

Δ
H max
68 m



STKOR

No.	W	l / h	H max (m)	Icon
79943	280	1020	68	4

- PL Pompa ogrodowa
 GB Jet pump
 D Gartenpumpe
 RUS Насос садовый
- CZ Zahradní čerpadlo
 RO Pompă apa
 H Kerti szivattyúhoz
 E Bomba de jardín con cabeza

230V~
50Hz



FLO

$L_{pA} = 67,5 \pm 3,0$ dB; $L_{wA} = 78,5 \pm 3,0$ dB

No.	W	l / h	H (max)	max. pressure / max. ciśnienie (bar)	Icon
79912	600	2800	35	3.5	1
79913	800	3200	40	4.0	1

- PL Pompa zatapialna do wody brudnej
 GB Dirty water submersible pump
 D Tauchmotorpumpe
 RUS Погружной насос
 CZ Zátavovací čerpadlo
 RO Pompă pt. apă murdară
 H Búvárszivattyú
 E Bomba de inmersión para agua sucia

230V~
50Hz

1"
25mm

5/4"
32mm

1.5"
38mm



FLO

No.	W	l / h	H (max)	Icon
79790	750	14000	7.5	2
79791	900	16000	8.5	2
79792	1100	20000	9.0	2

- PL Pompa zatapialna do wody brudnej i ścieków
 GB Submersible pump for dirty water and wastewater
 D Tauchpumpe für Schmutzwasser
 RUS Погружной насос для грязной воды
 CZ Ponorné čerpadlo pro odpadní vody
 RO Pompă submersibilă pt. apă uzată
 H Búvárszivattyú szennyvíz
 E Bomba sumergible para aguas residuales

230V~
50Hz

450
W



FLO

No.	W	l / h	H (max)	Icon
79880	450	16000	9	1

- PL Pompa ogrodowa
 GB Jet pump
 D Gartenpumpe
 RUS Насос садовый
- CZ Zahradní čerpadlo
 RO Pompă apa
 H Kerti szivattyúhoz
 E Bomba de jardín con cabeza

230V~
50Hz



FLO

$L_{wA} = 95 \pm 3$ dB

No.	W	l / h	H (max)	max. pressure / max. ciśnienie (bar)	Icon
79810	600	2800	35	3.5	1
79811	800	3600	40	4.0	1
79812	1000	3800	44	4.4	1

PL Pompa fontannowa
GB Fountain pump
D Springbrunnenpumpe
RUS Фонтанный насос
CZ Fontánová pumpa
RO Pompa pt. fantana arteziana
H Pumpa szökőkúthoz
E Bomba para las fuentes

230V~
50Hz

3
NOZZLES
DYSZE

IPX8



No.	W	l / h	H (max)	
79926	8	600	1.0	12
79927	16	800	1.3	12
79928	22	1000	1.6	12

PL Pompa fontannowa
GB Fountain pump
D Springbrunnenpumpe
RUS Фонтанный насос
CZ Fontánová pumpa
RO Pompa pt. fantana arteziana
H Pumpa szökőkúthoz
E Bomba para las fuentes

230V~
50Hz

5
NOZZLES
DYSZE

IPX8



No.	W	l / h	H (max)	
79929	28	1400	2.0	8
79930	40	1800	2.5	8

PL Pompa fontannowa
GB Fountain pump
D Springbrunnenpumpe
RUS Фонтанный насос
CZ Fontánová pumpa
RO Pompa pt. fantana arteziana
H Pumpa szökőkúthoz
E Bomba para las fuentes

230V~
50Hz

CABLE
10m

IP68

5
NOZZLES



No.	W	l / h	H (max)	
79931	55	2000	2.5	8
79932	85	3000	3.5	8
79933	100	4500	4.5	6

PL Sekator uniwersalny
GB By-pass pruner
D Rebenschere
RUS Секатор

CZ Nožnice zahradnícke
RO Foarfece pt. pomi
H Metszoolló
E Podadera universal

180
mm



No.	L (mm)	
99193	180	12/120

PL Sekator uniwersalny
GB By-pass pruner
D Rebenschere
RUS Секатор

CZ Nožnice zahradnícke
RO Foarfece pt. pomi
H Metszoolló
E Podadera universal

200
mm



No.	L (mm)	
99230	200	20/60

PL Sekator uniwersalny
GB By-pass pruner
D Rebenschere
RUS Секатор

CZ Nožnice zahradnícke
RO Foarfece pt. pomi
H Metszoolló
E Podadera universal

190
mm



No.	L (mm)	
99194	190	12/120

PL Sekator uniwersalny
GB By-pass pruner
D Rebenschere
RUS Секатор

CZ Nožnice zahradnícke
RO Foarfece pt. pomi
H Metszoolló
E Podadera universal

200
mm

65
Mn



PTFE
COATED
POWERSAW



No.	L (mm)	
99190	200	18/72

PL Sekator uniwersalny
GB By-pass pruner
D Rebenschere
RUS Секатор

CZ Nožnice zahradnícke
RO Foarfece pt. pomi
H Metszoolló
E Podadera universal



FLO

No.	L (mm)	
99209	215	6/48

PL Sekator uniwersalny
GB By-pass pruner
D Rebenschere
RUS Секатор

CZ Nožnice zahradnícke
RO Foarfece pt. pomi
H Metszoolló
E Podadera universal



FLO

No.	L (mm)	
99203	215	20/60

PL Sekator uniwersalny
GB By-pass pruner
D Rebenschere
RUS Секатор

CZ Nožnice zahradnícke
RO Foarfece pt. pomi
H Metszoolló
E Podadera universal



FLO

No.	L (mm)	
99208	200	12/60

PL Sekator kowadelkowy
GB Professional anvil pruner
D Amboss-Gartenschere
RUS Секатор

CZ Nožnice zahradnícke
RO Foarfece pt. pomi
H Metszoolló
E Podadera de bigornia



FLO

No.	L (mm)	
99191	200	18/72

PL Sekator uniwersalny
GB By-pass pruner
D Rebenschere
RUS Секатор

CZ Nožnice zahradnícke
RO Foarfece pt. pomi
H Metszoolló
E Podadera universal



FLO

No.	L (mm)	
99202	180	18/72

PL Sekator uniwersalny
GB By-pass pruner
D Rebenschere
RUS Секатор

CZ Nožnice zahradnícke
RO Foarfece pt. pomi
H Metszoolló
E Podadera universal

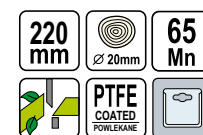

FLO

No.	L (mm)	
99204	220	20/60

PL Sekator kowadelkowy
GB Professional anvil pruner
D Amboss-Gartenschere
RUS Секатор

CZ Nožnice zahradnícke
RO Foarfece pt. pomi
H Metszoolló
E Podadera de bigornia



FLO

No.	L (mm)	
99207	205	20/60

PL Sekator wielofunkcyjny
GB Garden pocket pruner
D Rebenschere
RUS Секатор

CZ Nožnice zahradnícke
RO Foarfece pt. pomi
H Metszoolló
E Tijeras de podar



FLO

No.	L (mm)	
99210	200	12/48

PL Sekator do obcinania zawiązków
GB Fruit and flowers shears
D Blumen- und Rebschere
RUS Секатор

CZ Nožnice zahradnicke
RO Foarfece pt. pomi
H Metszoolló
E Podadera para cortar germenos



No.	L (mm)	Box
99240	190	12/72

PL Nożyce florystyczne
GB Flower shears
D Blumenschere
RUS Цветочные ножницы

CZ Květinové nůžky
RO Foarfece de grădină
H Virág ollók
E Tijeras de podar



No.	L (mm)	Box
99181	145	12/120

PL Sekator do gałęzi
GB By-pass lopping shears
D Astschere
RUS Сучкорез

CZ Nožnice zahradnicke
RO Foarfece curbata pt. taiat crengi
H Ágvágó fix
E Podadera para ramas

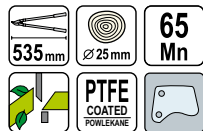

No.	L (mm)	Box
99103	535	12

PL Sekator do gałęzi
GB By-pass lopping shears
D Astschere
RUS Сучкорез

CZ Nožnice zahradnicke
RO Foarfece curbata pt. taiat crengi
H Ágvágó fix
E Podadera para ramas



No.	L (mm)	Box
99116	690	12

PL Nożyce florystyczne
GB Flower shears
D Blumenschere
RUS Цветочные ножницы

CZ Květinové nůžky
RO Foarfece de grădină
H Virág ollók
E Tijeras de podar



No.	L (mm)	Box
99180	170	12/120

PL Nożyce florystyczne
GB Flower shears
D Blumenschere
RUS Цветочные ножницы

CZ Květinové nůžky
RO Foarfece de grădină
H Virág ollók
E Tijeras de podar



No.	L (mm)	Box
99182	165	12/120

PL Sekator do gałęzi
GB By-pass lopping shears
D Astschere
RUS Сучкорез

CZ Nožnice zahradnicke
RO Foarfece curbata pt. taiat crengi
H Ágvágó fix
E Podadera para ramas

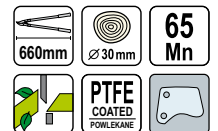

No.	L (mm)	Box
99109	660	12

PL Sekator do gałęzi
GB By-pass lopping shears
D Astschere
RUS Сучкорез

CZ Nožnice zahradnicke
RO Foarfece curbata pt. taiat crengi
H Ágvágó fix
E Podadera para ramas



No.	L (mm)	Box
99111	700	12

PL Sekator do gałęzi
 GB Anvil lopping shears
 D Astschere
 RUS Сучкорез с храповым механизмом
 CZ Nožnice zahradnicke na hrubé konáre
 RO Foarfeca curbata pt. taiat crengi
 H Ágvágó fix
 E Podadera para ramas con carraca

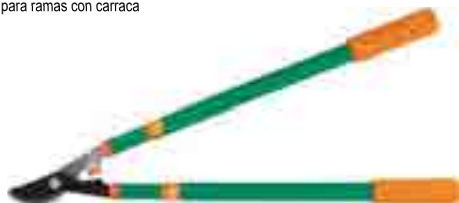
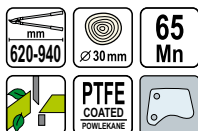

FLO

No.	L (mm)	
99115	620-940	12

PL Sekator do gałęzi
 GB Anvil lopping shears
 D Astschere
 RUS Сучкорез с храповым механизмом
 CZ Nožnice zahradnicke na hrubé konáre
 RO Foarfeca curbata pt. taiat crengi
 H Ágvágó fix
 E Podadera para ramas con carraca

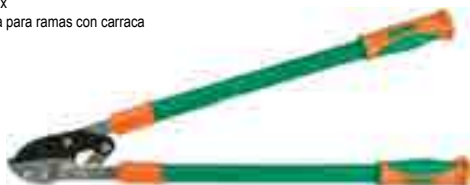

FLO

No.	L (mm)	
99112	690	12

PL Przedłużka teleskopowa
 GB Telescopic handle
 D Teleskopstange
 RUS Рукоятка телескопическая

CZ Teleskopický prodlužovač
 RO Prelungitor telescopic
 H Teleszkópos hosszabbító
 E Tubo de prolongación telescópico

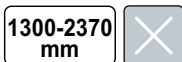

FLO

No.	L (mm)	
99315	1300-2370	12

PL Nożyce do żywoplotu
 GB Hedge shears
 D Heckenschere
 RUS Кусторезы
 CZ Nožnice na živý plot
 RO Foarfeca pt. gard viu
 H Sövényvágó olló
 E Tijeras para seto vivo



FLO

No.	L (mm)	
99006	630	12

PL Sekator do gałęzi
 GB Anvil lopping shears
 D Astschere
 RUS Сучкорез с храповым механизмом
 CZ Nožnice zahradnicke na hrubé konáre
 RO Foarfeca curbata pt. taiat crengi
 H Ágvágó fix
 E Podadera para ramas con carraca

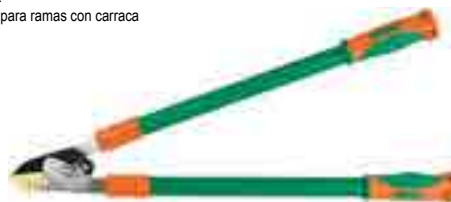

FLO

No.	L (mm)	
99110	660	12

PL Sekator gasienicowy z piłą
 GB Leverage tree pruner
 D Baumsäge mit Astschere
 RUS Сучкорез штанговый с пилой

CZ Stříhač na větve s pilovým listem
 RO Fierastrau pt. pomi cu prelungitor
 H Kőteles ágvágó
 E Podadera de palanca con sierra



FLO

No.	L (mm)	
99310	330	12/24

PL Nożyce do żywoplotu
 GB Hedge shears
 D Heckenschere
 RUS Кусторезы
 CZ Nožnice na živý plot
 RO Foarfeca pt. gard viu
 H Sövényvágó olló
 E Tijeras para seto vivo



FLO

No.	L (mm)	
99005	550	20

PL Nożyce do żywoplotu
 GB Hedge shears
 D Heckenschere
 RUS Кусторезы
 CZ Nožnice na živý plot
 RO Foarfeca pt. gard viu
 H Sövényvágó olló
 E Tijeras para seto vivo



FLO

No.	L (mm)	blade / ostrze L (mm)	
99007	590	185	18
99008	620	215	18

PL Nożyce do trawy wielopozycyjne
GB Grass shears
D Handgrassschere
RUS Ножницы для стрижки травы

CZ Nůžky na trávu
RO Foarfeca pt. gazon
H Forgatható fűvirító olló
E Tijeras de cesped

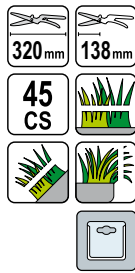

FLO

No.	L (mm)	
99300	320	12/48

PL Pila ogrodnicza - lisi ogon
GB Pruning saw
D Baumsäge
RUS Пила садовая

CZ Zahradnická pila - liščí ocas
RO Fierăstrău de grădină-coadă de vulpe
H Gallyazófűrész-rókafarkú
E Sierra de jardín - cola de zorro

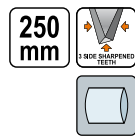

FLO

No.	L (mm)	
28640	250	12/120

PL Pila do gałęzi z kaburą
GB Pruning saw
D Bügelsäge
RUS Лучковая пила

CZ Oblouková pila
RO Fierăstrău pt. perforare
H Keretes fűrész
E Sierra de jardín

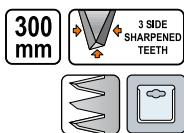

FLO

No.	L (mm)	
28642	300	12/36

PL Pila kablakowa
GB Bow saw
D Bügelsäge
RUS Лучковая пила

CZ Oblouková pila
RO Fierăstrău de curbură
H Keretes fűrész
E Sierra de arco



FLO

No.	L (mm)	
28745	530	12/24

PL Nożyce do trawy wielopozycyjne
GB Grass shears
D Handgrassschere
RUS Ножницы для стрижки травы

CZ Nůžky na trávu
RO Foarfeca pt. gazon
H Forgatható fűvirító olló
E Tijeras de cesped

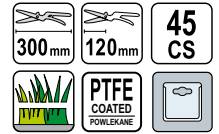

FLO

No.	L (mm)	
99301	300	12/48

PL Pila do gałęzi składana
GB Pruning saw
D Baumsäge
RUS Пила садовая

CZ Zahradnická pila
RO Fierăstrău pt. perforare
H Gallyazófűrész
E Sierra para ramos plegable

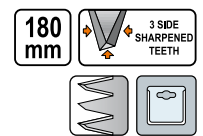

FLO

No.	L (mm)	
28641	180	20/60

PL Pila kablakowa
GB Bow saw
D Bügelsäge
RUS Лучковая пила

CZ Oblouková pila
RO Fierăstrău de curbură
H Keretes fűrész
E Sierra de arco



No.	L (mm)	
28740	515	24
28750	735	24

PL Pila kablakowa
GB Bow saw
D Bügelsäge
RUS Лучковая пила

CZ Oblouková pila
RO Fierăstrău de curbură
H Keretes fűrész
E Sierra de arco



FLO

No.	L (mm)	
28746	610	12/24
28755	760	12/24

PL Brzeszczot
 GB Spare blade for bow saw
 D Bügelsägeblatt
 RUS Полотно д/пилы „Лидер”

CZ Ostří na dřevo
 RO Panza fierastrau tip arc
 H Fűrészlap fához
 E Hoja de sierra

WET WOOD

DREWNO MOKRE



FLO

No.	L (mm)	W (mm)	
28771	530	20	60/240
28772	610	20	60/240
28773	760	20	60/240

PL Siekiera
 GB Axe
 D Handbeil
 RUS Топор

CZ Sekyrka
 RO Toporisca
 H Szekerce
 E Hacha



FLO

No.	g	
33067	600	24
33087	800	20
33107	1000	12
33127	1250	12
33147	1400	12
33177	1600	12

PL Siekiera, rączka z włókna szklanego
 GB Axe with fibreglass + PVC handle
 D Handbeil Fiberglasstiel
 RUS Топор с фиберглассовой ручкой

CZ Sekyrka
 RO Toporisca cu coada din fibra de sticla
 H Szekerce
 E Hacha con mango de fibra de vidrio



VOREL

No.	g	
33065	600	20
33085	800	20
33105	1000	12
33125	1250	6

PL Siekiera ze stali kutej
 GB Drop forged hatchet
 D Handbeil
 RUS Топор стальной кованый

CZ Sekera ocelová kovaná
 RO Toporisca lama forjata
 H Kovácsolt acél fejsze
 E Hacha de metalo forjado



FLO

No.	kg	
33080	0.8	12/24

PL Siekiera
 GB Axe
 D Handbeil
 RUS Топор

CZ Sekyrka
 RO Toporisca
 H Szekerce
 E Hacha



FLO

No.	kg	
32930	1.0	10

PL Siekiera
 GB Axe
 D Handbeil
 RUS Топор

CZ Sekyrka
 RO Toporisca
 H Szekerce
 E Hacha

DIN
5131
7294



UJO

No.	kg	
33024	0.4	5
33026	0.6	5
33028	0.8	5
33030	1.0	5
33032	1.25	5
33035	1.50	5
33038	1.80	5
33039	2.0	5
33040	2.50	5

PL Siekiera
GB Axe
D Handbeil
RUS Топор

CZ Sekyrka
RO Toporisca
H Szekerce
E Hacha

DIN
5131
7294



JUJO

No.	kg	
33000	0.4	5
33001	0.6	5
33002	0.8	5
33003	1.0	5
33004	1.25	5
33005	1.50	5
33006	1.80	5
33007	2.0	5
33008	2.50	5

PL Siekiero-młot
GB Hammer-axe for wood splitting
D Spaltaxt
RUS Топор-колун

CZ Sekera-kladivo
RO Secure-ciocan
H Szekerce-kalapács
E Hacha martillo para partir madera



JUJO

No.	kg	
32925	2.5	1
32926	4.0	1

PL Siekiera kanadyjska
GB Canadian axe
D Handbeil „Kanadische Form“
RUS Топор тип канадский

CZ Sekera kanadská
RO Topor canadian
H Hosszú nyelű, hasító fejsze
E Hacha canada

1.8
kg



JUJO

No.	kg	
33022	1.8	5

PL Siekiera z klinem
GB Axe
D Handbeil
RUS Топор

CZ Sekyrka
RO Toporisca
H Szekerce
E Hacha



JUJO

No.	kg	
32924	2	5

PL Siekiero-młot
GB Hammer-axe for wood splitting
D Spaltaxt
RUS Топор-колун

CZ Sekera-kladivo
RO Secure-ciocan
H Szekerce-kalapács
E Hacha martillo para partir madera



JUJO

No.	kg	
32927	2.1	1
32928	3.2	1

PL Zestaw klinujący
GB Hammer wedges
D Keilesatz
RUS Набор клинов

CZ Sada klínků
RO Set cultivator
H Ékelő készlet
E Juego de sujeción



JUJO

No.	for hammer / do mlotka (kg)	for axe / do siekiery (kg)	
99460	0.1-0.5	-	50
99461	0.7-2.0	-	50
99462	3.0-4.0	0.4	50

PL Zestaw klinujący
GB Hammer wedges
D Keilesatz
RUS Набор клинов

CZ Sada klínků
RO Set cultivator
H Ékelő készlet
E Juego de sujeción



JICO

No.	for hammer / do młotka (kg)	for axe / do siekiery (kg)	
99463	5-6	0.6-1.0	50
99464	8-10	1.2-2.5	50

PL Łopátka
GB Trowel
D Blumenkelle
RUS Совок посадочный

CZ Lopatka
RO Mini-lopata gradinarit
H Ásó
E Paleta ancha



FLO

No.	L (mm)	
99048	350	25/100

PL Grabki
GB Rake
D Kleinrechen
RUS Грабли

CZ Hrabičky
RO Mini grebla
H Gereblye
E Rastrillo



FLO

No.	L (mm)	
99051	300	25/100

PL Motyczka
GB Hoe
D Garten Handhacke
RUS Мотыжка

CZ Motyčka
RO Săpăligă
H Kerti kapa
E Azadilla



FLO

No.	L (mm)	
99052	300	100

PL Klin do rozłupywania drewna
GB Wood splitter
D Spaltkeil
RUS Клин для раскалывания бревен

CZ Klín na štípání polen
RO Pana pt. lemn
H Fahasító ék
E Cuiña para partir madera



JICO

No.	kg	
32922	2	1
32923	3	1

PL Łopátka
GB Trowel
D Blumenkelle
RUS Совок посадочный

CZ Lopatka
RO Mini-lopata gradinarit
H Ásó
E Paleta ancha



FLO

No.	L (mm)	
99047	350	25/100

PL Motyczka z pazurkami
GB Hoe + cultivator
D Kleinhacke
RUS Рыхлитель комбинированный

CZ Motyčka s hrabičkami
RO Săpăligă + cultivator
H Kerti villás kapa
E Azadilla con escarificador



FLO

No.	L (mm)	
99050	300	50

PL Pazurki
GB Cultivator
D Grubber
RUS Рыхлитель садовый

CZ Kultivátor
RO Cultivator
H Kultivátor
E Escarificador



FLO

No.	L (mm)	
99049	310	25/100

PL Łopatka
GB Trowel
D Blumenkelle
RUS Совок посадочный

CZ Lopatka
RO Mini-lopată gradinarit
H Ásó
E Paleta ancha

320 mm



No.	L (mm)	
35765	320	50

PL Pazurki
GB Cultivator
D Grubber
RUS Рыхлитель садовый

CZ Kultivátor
RO Cultivator
H Kultivátor
E Escarificador

330 mm



No.	L (mm)	
35767	330	50

PL Łopatka
GB Trowel
D Blumenkelle
RUS Совок посадочный

CZ Lopatka
RO Mini-lopată gradinarit
H Ásó
E Paleta ancha

330 mm



No.	L (mm)	
99035	330	24/48

PL Motyczka z pazurkami
GB Hoe + cultivator
D Kleinhacke
RUS Рыхлитель комбинированный

CZ Motyčka s hrabičkami
RO Săpăligă + cultivator
H Kerti villás kapa
E Azadilla con escarificador

300 mm



No.	L (mm)	
99037	300	24/48

PL Motyczka
GB Hoe
D Garten Handhacke
RUS Мотыжка

CZ Motyčka
RO Săpăligă
H Kerti kapa
E Azadilla

350 mm



No.	L (mm)	
35768	350	50

PL Łopatka
GB Trowel
D Blumenkelle
RUS Совок посадочный

CZ Lopatka
RO Mini-lopată gradinarit
H Ásó
E Paleta ancha

330 mm



No.	L (mm)	
99034	330	24/48

PL Grabki
GB Rake
D Kleinrechen
RUS Грабли

CZ Hrabičky
RO Mini grebla
H Gereblye
E Rastrillo

300 mm



No.	L (mm)	
99036	300	24/48

PL Pazurki
GB Cultivator
D Grubber
RUS Рыхлитель садовый

CZ Kultivátor
RO Cultivator
H Kultivátor
E Escarificador

395 mm



No.	L (mm)	
99038	395	24/48

PL Grabki
GB Rake
D Kleinrechen
RUS Грабли

CZ Hrabičky
RO Mini grebla
H Gereblye
E Rastrillo

450 mm



FLO

No.	L (mm)	Icon
99039	450	24/48

PL Sadzarka do cebuli
GB Bulb planter
D Blumenweibelpflanzer
RUS Конус посадочный для рассады



FLO

No.	Icon
99033	10/60

PL Saperka wielofunkcyjna
GB Multifunctional shovel
D Kombi-Faltschaufel
RUS Сапёрная лопата многофункциональная

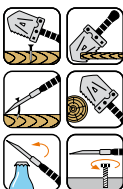

FLO

No.	Icon
99053	36

PL Komplet narzędzi ogrodowych
GB Garden tool set
D Garten-Kleingerätesatz
RUS Набор садово-огородного инструмента

CZ Sada zahradnického náčiní
RO Set pt. grăndinărit
H Kertész készlet
E Juego de herramientas de jardín

3 PCS



FLO

No.	L (mm)	Icon
99028	205	50

PL Chwastownik
GB Patio weeder
D Fugenkratzer
RUS Очиститель щелевой

CZ Čistič mezer
RO Cuiț pt. curățat dale
H Fugakaparó
E Musgo cuchillo

320 mm



FLO

No.	L (mm)	Icon
99040	320	24/48

PL Zbierek do owoców
GB Fruit pick up tool
D Obstpfücker
RUS Съёмник для фруктов



FLO

No.	Ø (mm)	Icon
99880	160	12/48

PL Saperka składana
GB Folding shovel
D Faltschaufel
RUS Сапёрная лопата складная



FLO

No.	Icon
99054	36

PL Komplet narzędzi ogrodowych
GB Garden tool set
D Garten-Kleingerätesatz
RUS Набор садово-огородного инструмента

CZ Sada zahradnického náčiní
RO Set pt. grăndinărit
H Kertész készlet
E Juego de herramientas de jardín

4 PCS



FLO

No.	pcs	Icon
99056	4	10/60

PL Szpadeł szkolkarski
GB Transplanting spade
D Schulspaten
RUS Лопата штыковая дренажная

CZ Školkařský rýč
RO Cazma de puiet
H Faiskolai ásó
E Pala de vivero



No.	type	
35811	DY	140

PL Szpadeł
GB Spade
D Rodespaten
RUS Заступ

CZ Lisovaný rýč kalená
RO Hârleț cu coadă
H Ásó, sajtolt-edzett
E Pala



No.	type	
35810	DY	200

PL Łopata piaskowa
GB Shovel
D Schaufel
RUS Лопата совковая песочная

CZ Osazený rýč pískový
RO Lopată pt. nisip
H Homoklapát
E Pala arena



No.	type	
35843	DY	120

PL Łopata kanadyjska
GB Gardening shovel
D Kanadischer Spaten
RUS Лопата канадская

CZ Rycí lopata
RO Lopată canadiană
H Ásólapát
E Pala canadiense



No.	type	
35855	DY	140

PL Szpadeł
GB Spade
D Rodespaten
RUS Заступ

CZ Lisovaný rýč kalená
RO Hârleț cu coadă
H Ásó, sajtolt-edzett
E Pala



No.	type	
35809	DY	200

PL Saperka profilowana
GB Mini shovel
D Feldspaten
RUS Лопата саперная

CZ Vojenská lopata
RO Lopată mică
H Profilozott ásó
E Zapa perfilada



No.	type	
35833	DY	250

PL Łopata piaskowo - żwirowa
GB Shovel
D Schaufel
RUS Лопата совковая песочная

CZ Osazený rýč pískový
RO Lopată pt. nisip
H Homoklapát
E Pala arena



No.	type	
35861	DY	120

PL Łopata węglowa
GB Shovel
D Kohlschaufel
RUS Лопата угольная

CZ Úhlový rýč číslo
RO Lopată pt. carbune
H Szeneslapát
E Pala carbón



No.	type	
35863	DY	120

PL Widły
GB Digging fork
D Grabegabel
RUS Вилы свековичные кованые

CZ Zahradnické vidlice
RO Furcă pt. grădină
H Vasvilla
E Horca



No.	type	
35817	DY	250

PL Motyka
GB Garden hoe
D Garten Handhacke
RUS Тяпка

CZ Motyčka
RO Sapaliga
H Kerti kapa
E Azadilla



No.	working part width / szer. części roboczej (cm)	type	
35761	12	P	500
35762	14	P	500

PL Pazurki oprawione
GB Cultivator
D Grubber
RUS Рыкхлитель садовый

CZ Kultivátor
RO Cultivator
H Kultivátor
E Escarificador



No.	type	
35705	P	250

PL Grabie wachlarzowe regulowane
GB Shrub rake
D Laubbesen Fächerbesen Regulierbar
RUS Грабли веерные регулируемые

CZ Hrábě vějířovité nastavitelné
RO Greblă evantai reglabilă
H Állítható lombseprű
E Rastrillos ventilador ajustables



No.	working part width / szer. części roboczej (mm)	teeth / zęby	
35797	255 / 580	20	5

PL Grabie
GB Rake
D Rechen
RUS Грабли

CZ Hrábě
RO Greblă
H Gereblye
E Rastrillo



No.	teeth / zęby	type	
35756	10	P	250
35757	12	P	250
35758	14	P	250
35759	16	P	250

PL Kultywator ręczny oprawiony
GB Hand cultivator with handle
D Handkultivator, eingefasst
RUS Культиватор ручной садовый

CZ Ruční kultivátor s násadou
RO Cultivator cu maner
H Kézi kultivátor, nyeles
E Cultivador manual enmarcado



No.	type	
35701	P	250

PL Grabie wachlarzowe
GB Spring rake
D Landschaftsbesen
RUS Грабли веерные

CZ Hrábičky
RO Greblă de gradina
H Kerti gereblye
E Rastrillo de abanico de hojalata



No.	working part width / szer. części roboczej (cm)	teeth / zęby	
35799	40	21	250

PL Świdler ręczny do gleby
GB Gimlet to the soil
D Handbohrer für den Erdboden
RUS Ручной почвенный бур

CZ Ruční vrták do půdy
RO Sfredel manual pt. pământ
H Kézi talajfúró
E Taladro manual para suelo



No.	Ø (mm)	
35670	170	50
35671	250	24

PL Nóż do darni
GB Long handle steel edger
D Rasenkantenstecher
RUS Полулуный нож
для обрезки краев дерна

CZ Nuz na okraje travniku
RO Tăietor de borduri
H Gyepgondozas
E Cortador de bordes
para césped



No.	working part width / szer. części roboczej (mm)	type	
35680	200	T	200

PL Szpadel
GB Spade
D Rodespaten
RUS Заступ

CZ Lisovaný ryč kalená
RO Hârleț cu coadă
H Ásó, sajtolt-edzett
E Pala



No.	type	
35802	T	140

PL Szpadel
GB Spade
D Rodespaten
RUS Заступ

CZ Lisovaný ryč kalená
RO Hârleț cu coadă
H Ásó, sajtolt-edzett
E Pala



No.	type	
35803	DY	140

PL Szpadel
GB Spade
D Rodespaten
RUS Заступ

CZ Lisovaný ryč kalená
RO Hârleț cu coadă
H Ásó, sajtolt-edzett
E Pala



No.	type	
35806	DY	140

PL Szpadel
GB Spade
D Rodespaten
RUS Заступ

CZ Lisovaný ryč kalená
RO Hârleț cu coadă
H Ásó, sajtolt-edzett
E Pala



No.	type	
35800	T	140

PL Szpadel
GB Spade
D Rodespaten
RUS Заступ

CZ Lisovaný ryč kalená
RO Hârleț cu coadă
H Ásó, sajtolt-edzett
E Pala



No.	type	
35801	T	140

PL Szpadel
GB Spade
D Rodespaten
RUS Заступ

CZ Lisovaný ryč kalená
RO Hârleț cu coadă
H Ásó, sajtolt-edzett
E Pala



No.	type	
35805	DY	140

PL Szpadel drenarski, nitowany
GB Riveted drainage spade
D Drainagespaten, genietet
RUS Лопата дренажная сборная

CZ Ryč drenážní nýtovaný
RO Sapă drenaj nitut
H Szegecseltt drénező ásó
E Pala de drenaje remachada



No.	type	
35807	T	140

PL Szpadel drenarski, profilowany
 GB Roll formed drainage spade
 D Drainagespaten, profiliert
 RUS Лопата дренажная цельноштампованная

CZ Rýč drenážní profilovaný
 RO Sapă drenaj profilată
 H Profilozott drénező ásó
 E Pala de drenaje perfilada



No.	type	
35808	DY	140

PL Łopata piaskowa
 GB Shovel
 D Schaufel
 RUS Лопата совковая песочная

CZ Osazený rýč pískový
 RO Lopată pt. nisip
 H Homoklapát
 E Pala arena



No.	type	
35840	T	200

PL Łopata węglowa
 GB Shovel
 D Kohlenschaufel
 RUS Лопата угольная

CZ Úhlový rýč číslo
 RO Lopată pt. cărbune
 H Szénslapát
 E Pala carbón



No.	type	
35850	T	120

PL Łopata piaskowa
 GB Shovel
 D Schaufel
 RUS Лопата совковая песочная

CZ Osazený rýč pískový
 RO Lopată pt. nisip
 H Homoklapát
 E Pala arena



No.	L (cm)	type	
35842	135	P	100

PL Łopata piaskowa
 GB Shovel
 D Schaufel
 RUS Лопата совковая песочная

CZ Osazený rýč pískový
 RO Lopată pt. nisip
 H Homoklapát
 E Pala arena



No.	type	
35839	DY	120

PL Łopata
 GB Shovel
 D Schaufel
 RUS Лопата

CZ Lopata
 RO Lopată
 H Homoklapát
 E Pala



No.	type	
35846	DY	250

PL Łopata węglowa
 GB Shovel
 D Kohlenschaufel
 RUS Лопата угольная

CZ Úhlový rýč číslo
 RO Lopată pt. cărbune
 H Szénslapát
 E Pala carbón



No.	type	
35860	DY	90

PL Widły
 GB Digging fork
 D Grabegabel
 RUS Вилы свекловичные кованые

CZ Zahradnické vidlice
 RO Furcă pt. grădină
 H Vasvilla
 E Horca



No.	teeth / zęby	type	
35815	3	P	100
35816	4	P	200

PL Widły
GB Digging fork
D Grabegabel
RUS Вилы свекловичные кованые

CZ Zahradnické vidlice
RO Furcă pt. grădină
H Vasvilla
E Horca



No.	teeth / zęby	type	
35865	4	DY	140

PL Widły
GB Digging fork
D Grabegabel
RUS Вилы свекловичные кованые

CZ Zahradnické vidlice
RO Furcă pt. grădină
H Vasvilla
E Horca



No.	teeth / zęby	type	
35864	4	DY	140

PL Grabie
GB Rake
D Rechen
RUS Грабли

CZ Hrábě
RO Greblă
H Gereblye
E Rastrillo



No.	teeth / zęby	type	
35781	10	P	10
35782	12	P	10
35784	14	P	10
35783	16	P	10

PL Grabie wachlarzowe
GB Spring rake
D Landschaftsbesen
RUS Грабли веерные

CZ Hrabičky
RO Grebla de gradina
H Kerti gereblye
E Rastrillo de abanico de hojalata



No.	L (mm)	teeth / zęby	
35785	435	23	12

PL Widły
GB Digging fork
D Grabegabel
RUS Вилы свекловичные кованые

CZ Zahradnické vidlice
RO Furcă pt. grădină
H Vasvilla
E Horca



No.	teeth / zęby	type	
35813	4	DY	100

PL Pazurki oprawione
GB Cultivator
D Grubber
RUS Рыхлитель садовый

CZ Kultivátor
RO Cultivator
H Kultivátor
E Escarificador



No.	type	
35763	P	5

PL Grabie
GB Rake
D Rechen
RUS Грабли

CZ Hrábě
RO Greblă
H Gereblye
E Rastrillo



No.	L (cm)	teeth / zęby	
35779	150	12	150
35780	150	16	155

PL Grabie wachlarzowe
GB Spring rake
D Landschaftsbesen
RUS Грабли веерные

CZ Hrabičky
RO Grebla de gradina
H Kerti gereblye
E Rastrillo de abanico de hojalata



No.	L (mm)	teeth / zęby	
35798	390	21	58

PL Grabie wachlarzowe metalowe
 GB Metal fan rake
 D Metall-Fächerbesen
 RUS Грабли для уборки листьев металлические
 CZ Kovové vějířové hrábě
 RO Greblă evantai de metal
 H Fém levelgereblye
 E Rastrillo de abanico de metal

530 mm



FLO

No.	L (mm)	
99400	530	24

PL Motyczka z pazurkami
 GB Hoe + cultivator
 D Kleinhacke
 RUS Рыхлитель комбинированный

CZ Motyčka s hrabičkami
 RO Sapaliga + cultivator
 H Kerti villás kapa
 E Azadilla con escarificador

P



FLO

No.	type	
35792	P	5

PL Motyka
 GB Garden hoe
 D Garten Handhacke
 RUS Тяпка

CZ Motyčka
 RO Sapaliga
 H Kerti kapa
 E Azadilla

P



FLO

No.	working part width / szer. części roboczej (cm)	type	
35773	12	P	500
35774	14	P	500
35776	16	P	5

PL Grabie plastikowe
 GB Plastic rake
 D Plasteharcken
 RUS Грабли пластиковые

CZ Plastové hrábě
 RO Greblă de plastic
 H Műanyag gereblye
 E Rastrillo de plástico

X



FLO

No.	L (mm)	teeth / zęby	
35788	550	16	10
35789	590	18	10

PL Motyczka z pazurkami
 GB Hoe + cultivator
 D Kleinhacke
 RUS Рыхлитель комбинированный

CZ Motyčka s hrabičkami
 RO Sapaliga + cultivator
 H Kerti villás kapa
 E Azadilla con escarificador

P



FLO

No.	type	
35764	P	5

PL Motyka
 GB Garden hoe
 D Garten Handhacke
 RUS Тяпка

CZ Motyčka
 RO Sapaliga
 H Kerti kapa
 E Azadilla

P



FLO

No.	working part width / szer. części roboczej (cm)	type	
35770	17	P	5

PL Motyka
 GB Garden hoe
 D Garten Handhacke
 RUS Тяпка

CZ Motyčka
 RO Sapaliga
 H Kerti kapa
 E Azadilla

P



FLO

No.	working part width / szer. części roboczej (cm)	type	
35777	17	P	5

PL Wertykulator do trawy
 GB Grass cultivator
 D Schneidrechen
 RUS Грабли азрационные

CZ Kultivátor oboustranný
 RO Cultivator
 H Kétoldalas talajlazító, gyephez
 E Cultivador de dos lados

380 mm



FLO

No.	L (mm)	
35700	380	5

PL Grabie CZ Hrábě
 GB Rake RO Greblă
 D Rechen H Gereblye
 RUS Грабли E Rastrillo



No.	L (mm)	teeth / zęby	
35750	270	12	48
35751	340	14	28

PL Grabie wachlarzowe CZ Hrabíčky
 GB Spring rake RO Grebla de gradina
 D Landschaftsbesen H Kerti gereblye
 RUS Грабли веерные E Rastrillo de abanico de hojalata



No.	L (mm)	teeth / zęby	
35786	435	23	10

PL Grabie wachlarzowe CZ Hrabíčky
 GB Spring rake RO Grebla de gradina
 D Landschaftsbesen H Kerti gereblye
 RUS Грабли веерные E Rastrillo de abanico de hojalata



No.	L (mm)	teeth / zęby	
35790	435	20	20
35791	580	27	20

PL Grabie wachlarzowe metalowe
 GB Metal fan rake
 D Metall-Fächerbesen
 RUS Грабли для уборки листьев металлические
 CZ Kovové vějířové hrábě
 RO Greblă evantai de metal
 H Fém levelgereblye
 E Rastrillo de abanico de metal



No.	L (mm)	
99390	430	40

PL Grabie CZ Hrábě
 GB Rake RO Greblă
 D Rechen H Gereblye
 RUS Грабли E Rastrillo



No.	L (mm)	teeth / zęby	
35755	360	14	20

PL Grabie wachlarzowe CZ Hrabíčky
 GB Spring rake RO Grebla de gradina
 D Landschaftsbesen H Kerti gereblye
 RUS Грабли веерные E Rastrillo de abanico de hojalata



No.	L (mm)	teeth / zęby	
35787	455	20	10

PL Grabie wachlarzowe metalowe
 GB Metal fan rake
 D Metall-Fächerbesen
 RUS Грабли для уборки листьев металлические
 CZ Kovové vějířové hrábě
 RO Greblă evantai de metal
 H Fém levelgereblye
 E Rastrillo de abanico de metal



No.	L (mm)	
99391	460	50

PL Grabie wachlarzowe metalowe
 GB Metal fan rake
 D Metall-Fächerbesen
 RUS Грабли для уборки листьев металлические
 CZ Kovové vějířové hrábě
 RO Greblă evantai de metal
 H Fém levélgereblye
 E Rastrillo de abanico de metal



425 mm



PL Pazurki
 GB Cultivator
 D Grubber
 RUS Рыхлитель садовый

CZ Kultivátor
 RO Cultivator
 H Kultivátor
 E Escarificador



FLO

No.	L (mm)	
35793	100	60
35794	130	60

FLO

No.	L (mm)	
99401	425	60

PL Obsypnik
 GB Cultivator
 D Häufner
 RUS Культиватор

CZ Zасыпávač
 RO Cultivator
 H Kultivátor
 E Arado

190 mm



PL Motyczka
 GB Hoe
 D Garten Handhacke
 RUS Мотыжка

CZ Motyčka
 RO Săpăligă
 H Kerti kapa
 E Azadilla

160 mm



FLO

No.	L (mm)	
35775	160	30

FLO

No.	L (mm)	
35710	190	5/15

PL Motyczka z pazurkami
 GB Hoe + cultivator
 D Kleinhacke
 RUS Рыхлитель комбинированный

CZ Motyčka s hrabičkami
 RO Săpăligă + cultivator
 H Műanyag hólapát
 E Azadilla con escarificador

80 mm



PL Motyczka z pazurkami
 GB Hoe + cultivator
 D Kleinhacke
 RUS Рыхлитель комбинированный

CZ Motyčka s hrabičkami
 RO Săpăligă + cultivator
 H Kerti villás kapa
 E Azadilla con escarificador

70 mm



FLO

No.	L (mm)	
35795	70	60

FLO

No.	L (mm)	
35760	80	60

PL Łopata do śniegu
 GB Plastic shovel for snow
 D Kunststoff-Schneeschaufel
 RUS Лопата снеговая

CZ Lopata na sněh
 RO Lopată pt. zăpadă
 H Műanyag hólapát
 E Pala para nieve



PL Skuwacz do lodu
 GB Ice breaker
 D Eishammer
 RUS Прибор для скобления льда

CZ Skováč na led
 RO Spărgător pt. gheață
 H Jégtörő
 E Rompehielo mango



VOREL

No.	
35878	125

No.	
35880	180

PL Miotła
GB Broom
D Strassenbesen
RUS Метла

CZ Metla
RO Matura
H Partvis
E Cepillo pelo largo



No.	L (mm)	
35911	1150x22	140

PL Miotła
GB Broom
D Strassenbesen
RUS Метла

CZ Metla
RO Matura
H Partvis
E Cepillo pelo largo



No.	L (mm)	
35893	300	12
35894	400	12
35895	500	12

PL Miotła
GB Broom
D Strassenbesen
RUS Метла

CZ Metla
RO Matura
H Partvis
E Cepillo pelo largo



No.	bristle length / дългоść włosia (mm)	
35905	275	12

PL Miotła
GB Broom
D Strassenbesen
RUS Метла

CZ Metla
RO Matura
H Partvis
E Cepillo pelo largo



No.	bristle length / дългоść włosia (mm)	
35908	210	8

PL Miotła
GB Broom
D Strassenbesen
RUS Метла

CZ Metla
RO Matura
H Partvis
E Cepillo pelo largo



No.	L (mm)	
35912	1200x22	15

PL Miotła
GB Broom
D Strassenbesen
RUS Метла

CZ Metla
RO Matura
H Partvis
E Cepillo pelo largo



No.	L (mm)	
35899	250	12

PL Miotła
GB Broom
D Strassenbesen
RUS Метла

CZ Metla
RO Matura
H Partvis
E Cepillo pelo largo



No.	bristle length / дългоść włosia (mm)	
35906	135	12

PL Sierp
GB Sickle
D Sichel
RUS Сепр

CZ Srp
RO Secera
H Sărló
E Hoz



No.		
35832		30

- PL Kosa kuta
 GB Forged scythe
 D Sensenklänge geschmiedet
 RUS Коса
- CZ Kosa kovaná
 RO Lama de coasa
 H Kovácsolt kasza
 E Guadana forjada



No.	type	
35824	No 6	25
35826	No 7	25
35828	No 8	25

- PL Pierścień do kosy
 GB Ring for scythe
 D Befestigungsring für sense Verzinkt
 RUS Кольцо косное оцинкованное

- CZ Kroužek na kosu
 RO Bratară galvanizată pt. coasă
 H Kaszarögztető gyűrű
 E Anillo para guadana



No.		
35823		30

- PL Trzonek do kosy
 GB Wooden handle for scythe
 D Sensenstiel
 RUS Косовище деревянное

- CZ Násada na kosu
 RO Coadă din lemn
 H Kaszanyél
 E Astil para guadanas



No.	L (cm)	
35830	174	10

- PL Trzonek do łopaty
 GB Wooden handle for shovel
 D Schaufelstiel gerade
 RUS Черенок для лопаты

- CZ Násada na lopatu
 RO Coadă din lemn
 H Lapátnyél
 E Astil para pala



No.	L (cm)	type	
99410	130	P	10

- PL Klepadło do kosy
 GB Stake for scythe
 D Dengelamboss für Sensen
 RUS Бабка для отбивки кос (наковальня)

- CZ Naklepávací kovadlinka
 RO Inel de stângere - pt. coasă
 H Kaszarögztető gyűrű
 E Anillo para guadanas



No.		
35821		30

- PL Klin drewniany do kosy
 GB Wedge for scythe
 D Holzkeil für Sensen
 RUS Клиn деревянный для косы

- CZ Klín dřevěný na kosu
 RO Pană de lemn pt. coasă
 H Faék kaszához
 E Cuna de madera para guadanas



No.		
35831		12/144

- PL Trzonek uniwersalny
 GB Wooden handle
 D Universalstiel
 RUS Черенок для грабель

- CZ Násada univerzální
 RO Coadă din lemn
 H Univerzális nyél
 E Astil universal



No.	L (cm)	Ø (mm)	type	
99403	100	28	P	25
99404	110	28	P	25
99402	130	28	P	25
99408	150	28	P	25

- PL Trzonek do grabi wachlarzowych
 GB Wooden handle
 D Schaufelstiel P-Griff
 RUS Черенок для лопат

- CZ Násada na lopatu
 RO Coadă de lopată cu maner
 H Lapátnyél
 E Astil para pala



No.	L (cm)	Ø (mm)	type	
99415	130	21	P	25

PL Trzonek do miotły ulicznej
GB Wooden handle for broom
D Stiel für einen Straßenbesen
RUS Черенок для метлы

CZ Násada na silniční metlu
RO Coadă matura cu filet
H Utcaseprűnyél
E Palo de escoba de calle

125 cm



No.	L (cm)		
99420	125		25

PL Trzonek do miotły z gwintem
GB Broom handle with thread
D Besenstiel, Holz, mit Gewinde
RUS Черенок для метлы с резьбой

CZ Násada na metlu se závitem
RO Coadă de mătură cu filet
H Menetes seprűnyél
E Astil para escoba con rosca

120 cm **P**



No.	L (cm)	type	
99418	120	P	25

PL Trzonek do szpadła
GB Handle „T” for spade
D Spadestiel T-griff
RUS Черенок для лопаты

CZ Násada na rýč
RO Coadă din lemn
H Ásónyél
E Astil para laya

90 cm **T**



No.	L (cm)	type	
99407	90	T	10

PL Trzonek
GB Wooden handle
D Schaufelstiel D-Griff
RUS Черенок для лопат

CZ Násada na lopatu
RO Coadă de lopată cu maner
H Lapátnyél
E Astil para pala

90 cm **DY**



No.	L (cm)	type	
99412	90	DY	10

PL Trzonek do miotły z gwintem
GB Broom handle with thread
D Besenstiel, Holz, mit Gewinde
RUS Черенок для метлы с резьбой

CZ Násada na metlu se závitem
RO Coadă de mătură cu filet
H Menetes seprűnyél
E Astil para escoba con rosca

120 cm **P**



No.	L (cm)	type	Ø (mm)	
99416	120	P	22	25

PL Trzonek metalowy z gwintem
GB Steel handle with thread
D Besenstiel mit Gewinde
RUS Черенок с резьбой

CZ Násada na metlu se závitem
RO Coadă cu filet
H Menetes seprűnyél
E Astil para escoba con rosca

116 cm **P**



No.	L (cm)	Ø (mm)	
99419	116	22	25

PL Trzonek do łopaty
GB Wooden handle for shovel
D Schaufelstiel gerade
RUS Черенок для лопаты

CZ Násada na lopatu
RO Coadă din lemn
H Lapátnyél
E Astil para pala

115 cm **T**



No.	L (cm)	type	
99409	115	T	10

PL Trzonek
GB Wooden handle
D Schaufelstiel D-Griff
RUS Черенок для лопат

CZ Násada na lopatu
RO Coadă de lopată cu maner
H Lapátnyél
E Astil para pala

90 cm **DY**



No.	L (cm)	type	
99413	90	DY	10

PL Trzonek do toporka
GB Wooden handle for hammer-axe
D Beilstiel
RUS Черенок для топора

CZ Násada na sekeru - kalač
RO Coada de topor
H Ácsszekerce nyél
E Astil para hacha con martillo



No.	L (cm)	for head / do obucha (kg)	
99425	36	0.6	75
99426	40	0.6	25

PL Trzonek do siekiery
GB Axe handle
D Axtstiel
RUS Рукьятка топора

CZ Topůrko do sekery
RO Cap de topor
H Baltanyél
E Astil de hacha



No.	L (cm)	for head / do obucha (kg)	
99427	50	1.0	25
99428	60	1.0-1.25	25
99429	70	1.25-1.80	25

PL Trzonek do mlotka
GB Hammer handle
D Hammerstiel
RUS Рукьятка молотка

CZ Topůrko do kladiva
RO Cap de ciocan
H Kalapácsnyél
E Astil de martillo



No.	L (cm)	for head / do obucha (kg)	
99435	28	0.1-0.3	65
99436	32	0.3-0.7	65
99438	36	0.7-1.5	65
99440	40	0.8-2.0	50
99442	50	2.0-3.0	50
99443	60	3.0-4.0	25
99444	70	4.0-6.0	25
99445	80	5.0-8.0	25
99446	90	8.0-10	10

PL Trzonek do siekiero-mlota
GB Handle for hammer-axe
D Stiel für Hammeraxt
RUS Чернок для топора

CZ Násada na sekeru
RO Coada din lemn
H Baltanyél
E Astil para hachuela

90
cm



No.	L (cm)	for head / do obucha (kg)	
99405	90	2.5	10
99406	90	4.0	10

PL Trzonek do siekiery
GB Axe handle
D Axtstiel
RUS Рукьятка топора

CZ Topůrko do sekery
RO Cap de topor
H Baltanyél
E Astil de hacha

80
cm



No.	L (cm)	for head / do obucha (kg)	
99430	80	1.8-2	25

PL Spryskiwacz ciśnieniowy ręczny
GB Pressure sprayer
D Drucksprüher
RUS Ручной опрыскиватель
CZ Ruční tlakový postřikovač
RO Vermorel
H Permetező kézi
E Rociador de presión, de mano



No.	l	
89507	1.0	20
89508	1.5	15
89509	2.0	15

- PL Opryskiwacz ciśnieniowy
- GB Pressure sprayer
- D Drucksprüher
- RUS Ручной давательный опрыскиватель
- CZ Ruční tlakový postřikovač
- RO Pulverizator de mana
- H Permetező kézi
- E Rociador de presión

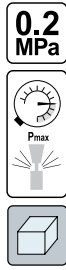

No.	l	
89515	5.0	6
89518	8.0	6

- PL Opryskiwacz ciśnieniowy plecakowy
- GB Pressure sprayer
- D Rücken-Drucksprüher
- RUS Опрыскиватель ранцевый
- CZ Tlakový postřikovač zádový
- RO Pulverizator portabil
- H Permetező hátí
- E Rociador de presión tipo „mochila”

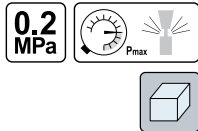

No.	l	
89526	15.0	1
89528	20.0	1

- PL Opryskiwacz ciśnieniowy
- GB Pressure sprayer
- D Drucksprüher
- RUS Ручной давательный опрыскиватель
- CZ Ruční tlakový postřikovač
- RO Pulverizator de mana
- H Permetező kézi
- E Rociador de presión



No.	l	
89520	8.0	6

- PL Pompa do spryskiwacza
- GB Pump for pressure sprayer
- D Druckpumpe für Drucksprüher
- RUS Насос на опрыскиватели
- CZ Pumpa do postřikovače
- RO Pompa pt. vermores
- H Szivattyú esőztetőhöz
- E Bomba para el rociador



No.	for / dla	
89536	89515; 89518; 89520	60

- PL Końcówka rozpylająca do spryskiwaczy
- GB Straight nozzle for pressure sprayer
- D Sprühdüse für Drucksprüher
- RUS Распылитель на опрыскиватели
- CZ Rozprašovací koncovka k postřikovači
- RO Doza pt. vermores
- H Porlasztó tömlővég esőztetőhöz
- E Puna de atomización para rociador



No.	for / dla	
89537	89515; 89518; 89520	300

- PL Zestaw końcówek rozpylających
GB Spray nozzle set
D Spritzdüsenatz
RUS Форсунки сменные для опрыскивателей
- CZ Sada rozprašovacích koncoviek
RO Set racorduri vermores
H Porlasztó fömlővég készlet
E Juego de boquillas rociadores



FLO

No.
89538

100

- PL Pistolet do opryskiwacza
GB Shower spray gun
D Spritzpistole
RUS Пистолет для опрыскивателей
- CZ Rozprašovací pistole na vodu
RO Pistol pt. stropit
H Locsoló pisztoly
E Pistola de pulverización ajustable



FLO

No.
89540

200

- PL Lanza teleskopowa
GB Telescopic handle
D Teleskoplanze
RUS Штанга телескопическая для опрыскивателя
- CZ Násadec teleskopický
RO Maner telescopic
H Teleszkópos lándzsza
E Lanza telescópica

70-118
cm



FLO

No.
89542

L (cm)
70-118

100

- PL Zestaw uszczelek do spryskiwaczy
GB Set of gaskets for pressure sprayer
D Dichtungssatz für Drucksprüher
RUS Набор прокладок для опрыскивателя
- CZ Sada těsnění k postřikovači
RO Set de garnituri pt. vermores
H Tömítéskészlet esőztetőhöz
E Juego de juntas para rociadores



- PL Pistolet do opryskiwacza
GB Shower spray gun
D Spritzpistole
RUS Пистолет для опрыскивателей
- CZ Rozprašovací pistole na vodu
RO Pistol pt. stropit
H Locsoló pisztoly
E Pistola de pulverización ajustable



FLO

No.
89539

200

- PL Lanca z włókna szklanego
GB Fibreglass spray lance
D Fibreglaslanze
RUS Трубка фиберглассовая
- CZ Násadec postřikovače ze skleněného vlákna
RO Lance din fibra de sticla
H Üveggyapot lándzsza
E Lanza de fibra de vidrio

80
cm



FLO

No.
89541

L (cm) Ø (mm)

80

8

250

- PL Przyłącze 4-dyszowe
GB 4-nozzle connector
D Querlanze mit 4 Düsen
RUS Штанга с 4 форсунками для опрыскивателей (вертикальная)
- CZ Připojka 4-trysková
RO Sistem irigații
H 4-fűvőkás csatlakozó
E Conexión de cuatro surtidores

645
mm



FLO

No.
89543

L (mm)
645

100

- PL Zestaw uszczelek do spryskiwaczy
GB Set of gaskets for pressure sprayer
D Dichtungssatz für Drucksprüher
RUS Набор прокладок для опрыскивателя
- CZ Sada těsnění k postřikovači
RO Set de garnituri pt. vermores
H Tömítéskészlet esőztetőhöz
E Juego de juntas para rociadores

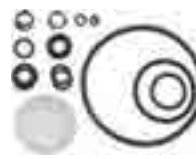

FLO

No.
89545

for / dla

89515; 89518; 89520

500

FLO

No.
89546

for / dla

89525

500

- PL Zestaw uszczeltek do spryskiwaczy
 GB Set of gaskets for pressure sprayer
 D Dichtungssatz für Drucksprüher
 RUS Набор прокладок для опрыскивателя
- CZ Sada těsnění k postřikovači
 RO Set de garnituri pt. vermores
 H Tömítéskészlet esőztetőhöz
 E Juego de juntas para rociadores



No.	for / dla	
89547	89526, 89528	500

- PL Akumulatorowa podkaszarka do trawy
 GB Cordless grass trimmer
 D Akku-Rasentrimmer
 RUS Аккумуляторные триммеры
 CZ Akumulátorová sekačka na trávu
 RO Trimmer de gazon cu acumulator
 H Akkus szegélynyíró
 E Desmalezadora inalámbrica



18 V 1.5 Ah
 8000 min⁻¹ 27 Wh
 Li-Ion TAPĂGO SPOOL HEAD TYPE GŁOWIŃCA TYPU TAPĂGO
 230 mm CHARGE LEVEL INDICATOR WSKAZNIK STANU NAŁADOWNIWA BATERII



$L_{pA} = 72,4 \pm 3,0$ dB; $L_{wA} = 67,37 \pm 3,0$ dB; $a_n = 1,45 \pm 1,5$ m/s²

No.	V	min-1	Ø (mm)	
79510	18	8000	230	2

- PL Akumulatorowe nożyce do trawy i krzewów
 GB Cordless grass and shrub shears
 D Akkuscherer mit Gras- und Strauchmesser
 RUS Аккумуляторные ножницы для травы и кустов
 CZ Akumulátorové nůžky na trávu a keře
 RO Trimmer cu acumulator pt. iarba si gard viu
 H Foarfecele cu acumulator pt. tăiat iarba
 E Tijeras a batería para hierba y arbustos



3,6 V 1,3 Ah Li-Ion 1000 min⁻¹
 Li-Ion 80 mm
 2in1 110 mm



$L_{pA} = 74,6 \pm 3,0$ dB; $L_{wA} = 86,4 \pm 3,0$ dB; $a_n = 1,63 \pm 1,5$ m/s²

No.	min-1	
79500	1000	8



- PL Podkaszarka elektryczna
 GB Electric trimmer
 D Elektro-Rasentrimmer
 RUS Электрический триммер
 CZ Elektrická sekačka
 RO Cositoare electrică
 H Elektromos fűnyíró
 E Segadora eléctrica



230V~ 50Hz 500 W
 10500 min⁻¹ 280 mm
 100 cm 80 cm 2 POSITIONS POZYCJE



$L_{pA} = 74,4 \pm 1,94$ dB; $L_{wA} = 94,1 \pm 1,94$ dB; $a_n = 0,794 \pm 1,5$ m/s²

No.	W	min-1	Ø (mm)	
79467	500	10500	280	4

- PL Akumulatorowe nożyce do trawy i krzewów
 GB Cordless grass and shrub shears
 D Akkuscherer mit Gras- und Strauchmesser
 RUS Аккумуляторные ножницы для травы и кустов
 CZ Akumulátorové nůžky na trávu a keře
 RO Trimmer cu acumulator pt. iarba si gard viu
 H Foarfecele cu acumulator pt. tăiat iarba
 E Tijeras a batería para hierba y arbustos



3,6 V 1,3 Ah Li-Ion 1000 min⁻¹
 Li-Ion 80 mm
 2in1 110 mm



$L_{pA} = 74,6 \pm 3,0$ dB; $L_{wA} = 86,4 \pm 3,0$ dB; $a_n = 1,63 \pm 1,5$ m/s²

No.	min-1	
79501	1000	8

- PL Akumulatorowe nożyce do żywoplotu
 GB Cordless hedge trimmer
 D Akku-Heckenschere
 RUS Аккумуляторный кусторез
 CZ Akumulátorové nůžky na živé ploty
 RO Akkus sövénynyíró
 H Foarfece de tăiat gard viu cu acumulator
 E Cortasetos inalámbrico



$L_{pA} = 81,6 \pm 3 \text{ dB}$; $L_{wA} = 101,6 \pm 3 \text{ dB}$; $a_n = 5,328 \pm 1,5 / 6,1214 \pm 1,5 \text{ m/s}^2$

No.	V	min-1	L (mm)	☐
79520	18	1100	440	2

- PL Nożyce do żywoplotu
 GB Hedge shears
 D Heckenscheren
 RUS Ножницы для живой изгороди
 CZ Nůžky na živý plot
 RO Foarfece pt. gard viu
 H Sövényvágó olló
 E Tijera para vallado



$L_{pA} = 75,2 \pm 0,6 \text{ dB}$; $L_{wA} = 95,2 \pm 0,6 \text{ dB}$; $a_n = 2,840 \pm 1,5 \text{ m/s}^2$

No.	W	min-1	L (mm)	☐
79444	520	1600	510	4

- PL Akumulator
 GB Battery
 D Akkumulator
 RUS Аккумулятор
 CZ Akumulátor
 RO Acumulatorul
 H Akkumulátor
 E Acumulador

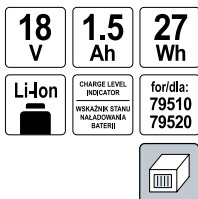

No.	V	for / dla	☐
79530	18	79510; 79520	25

- PL Elektryczne nożyce do żywoplotu
 GB Hedge shears
 D Heckenscheren
 RUS Ножницы для живой изгороди
 CZ Nůžky na živý plot
 RO Foarfece pt. gard viu
 H Sövényvágó olló
 E Tijera para vallado

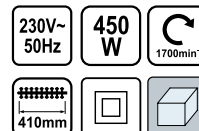

$L_{pA} = 81,6 \pm 3 \text{ dB}$; $L_{wA} = 101,6 \pm 3 \text{ dB}$; $a_n = 5,328 \pm 1,5 / 6,1214 \pm 1,5 \text{ m/s}^2$

No.	W	min-1	L (mm)	☐
79442	450	1700	410	4

- PL Nożyce do żywoplotu
 GB Hedge shears
 D Heckenscheren
 RUS Ножницы для живой изгороди
 CZ Nůžky na živý plot
 RO Foarfece pt. gard viu
 H Sövényvágó olló
 E Tijera para vallado



$L_{pA} = 78,58 \pm 1,489 \text{ dB}$; $L_{wA} = 98,54 \pm 1,489 \text{ dB}$; $a_n = 3,272 \pm 1,5 / 3,435 \pm 1,5 \text{ m/s}^2$

No.	W	min-1	L (mm)	☐
79448	550	1700	510	4

- PL Ładowarka do akumulatora
 GB Battery charger
 D Ladegerät
 RUS Зарядное устройство
 CZ Nabíječka
 RO Redresor
 H Akkutöltő
 E Rectificador

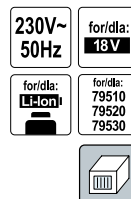

No.	V	for / dla	☐
79531	18	79510; 79520; 79530	25

- PL Pilnik okrągły do łańcuchów
 GB Chain saw file
 D Runde Kettenfeile
 RUS Цилиндрический напильник для цепей
 CZ Kulatý pilník na řetězy
 RO Pilă rotundă pt. lanțuri
 H Láncvágó körfűrész
 E Lima redonda para cadenas



No.	L (mm)	Ø (mm)	pcs / packing	
79861	200	4.0	3	200
79862	200	4.5	3	200
79863	200	4.8	3	200

- PL Klucz uniwersalny do narzędzi spalinowych
 GB Universal wrench for gasoline machines
 D Universalschlüssel für Benzin Maschinen
 RUS Универсальный ключ для бензинового инструмента
 CZ Univerzální klíč pro benzínové stroje
 RO Cheie universală pt. mașini pe benzină
 H Kulccsal benzín eszköz
 E Llave universal para máquinas de gasolina

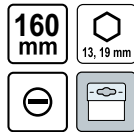

No.	
79869	10/100

- PL Glowica żyłkowa
 GB Line head
 D Trimmerkopf
 RUS Головка с леской
 CZ Strunová hlava
 RO Cap cu cablu
 H Damil fej
 E Cabezal de hilo

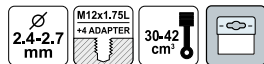

No.	Ø (mm)	
79551	2.4-2.7	10/40

- PL Glowica żyłkowa
 GB Line head
 D Trimmerkopf
 RUS Головка с леской
 CZ Strunová hlava
 RO Cap cu cablu
 H Damil fej
 E Cabezal de hilo



No.	Ø (mm)	for / dla	
79468	1.2	79467	20/100

- PL Prowadnik do pilnika do łańcuchów
 GB Guide for chain saw file
 D Führung für die Kettenfeile
 RUS Направляющая для напильника для цепей
 CZ Vedení pro pilník na řetězy
 RO Ghidaj pt. pila pt. lanțuri
 H Megvezető a láncfűrészhez
 E Guía de lima para cadenas



No.	chain pitch / podziałka łańcucha	Ø (mm)	
79865	3/8 picco	4.0	50/150
79866	microlite	4.5	50/150
79867	.325	4.8	50/150

- PL Glowica żyłkowa
 GB Line head
 D Trimmerkopf
 RUS Головка с леской
 CZ Strunová hlava
 RO Cap cu cablu
 H Damil fej
 E Cabezal de hilo



No.	Ø (mm)	
79550	2.0-2.4	10/40

- PL Glowica żyłkowa
 GB Line head
 D Trimmerkopf
 RUS Головка с леской
 CZ Strunová hlava
 RO Cap cu cablu
 H Damil fej
 E Cabezal de hilo



No.	Ø (mm)	
79552	2.4-2.7	10/40

- PL Żyłka tnąca
 GB Grass trimmer line
 D Mähfaden
 RUS Леска для триммера
 CZ Struna do strunové sekačky
 RO Furtun gradina
 H Damil szegélynyíró géphez
 E Hilo de cortar



No.	Ø (mm)	L (m)	profil	
89401	1.3	10	O	20/240
89402	1.6	10	O	20/240
89403	2.0	10	O	20/240
89404	2.4	10	O	12/144
89405	2.6	10	O	12/144
89406	3.0	10	O	12/144

PL Żyłka tnąca
GB Grass trimmer line
D Mähfaden
RUS Леска для триммера
CZ Struna do strunové sekačky
RO Furtun gradina
H Damil szegélynyíró géphez
E Hilo de cortar



FLO

No.	Ø (mm)	L (m)	profil	
89441	2.0	120	○	27
89442	2.4	90	○	27
89443	2.6	70	○	27
89444	3.0	56	○	27

PL Żyłka tnąca
GB Grass trimmer line
D Mähfaden
RUS Леска для триммера
CZ Struna do strunové sekačky
RO Furtun gradina
H Damil szegélynyíró géphez
E Hilo de cortar



FLO

No.	Ø (mm)	L (m)	profil	
89452	2.4	90	□	16
89453	2.6	70	□	16
89454	3.0	56	□	16

PL Żyłka tnąca
GB Grass trimmer line
D Mähfaden
RUS Леска для триммера
CZ Struna do strunové sekačky
RO Furtun gradina
H Damil szegélynyíró géphez
E Hilo de cortar



FLO

No.	Ø (mm)	L (m)	profil	
89456	2.0	90	☆	9/27
89457	2.4	90	☆	9/27
89458	2.6	90	☆	9/27
89459	3.0	60	☆	9/27

PL Żyłka tnąca
GB Grass trimmer line
D Mähfaden
RUS Леска для триммера
CZ Struna do strunové sekačky
RO Furtun gradina
H Damil szegélynyíró géphez
E Hilo de cortar



FLO

EXTRANYL

No.	Ø (mm)	L (m)	profil	
89465	2.4	90	□	10/20
89466	2.7	70	□	10/20
89467	3.0	60	□	10/20

PL Żyłka tnąca
GB Grass trimmer line
D Mähfaden
RUS Леска для триммера
CZ Struna do strunové sekačky
RO Furtun gradina
H Damil szegélynyíró géphez
E Hilo de cortar



FLO

No.	Ø (mm)	L (m)	profil	
89411	1.3	10	□	20/240
89412	1.6	10	□	20/240
89413	2.0	10	□	20/240
89414	2.4	10	□	12/144
89415	2.6	10	□	12/144
89416	3.0	10	□	12/144

PL Żyłka tnąca
GB Grass trimmer line
D Mähfaden
RUS Леска для триммера
CZ Struna do strunové sekačky
RO Furtun gradina
H Damil szegélynyíró géphez
E Hilo de cortar



FLO

No.	Ø (mm)	L (m)	profil	
89421	1.3	15	☆	24/288
89422	1.6	15	☆	20/240
89423	2.0	15	☆	16/192
89424	2.4	15	☆	12/144
89425	2.6	15	☆	12/144
89426	3.0	15	☆	10/120

PL Żyłka tnąca
GB Grass trimmer line
D Mähfaden
RUS Леска для триммера
CZ Struna do strunové sekačky
RO Furtun gradina
H Damil szegélynyíró géphez
E Hilo de cortar



FLO

EXTRANYL

No.	Ø (mm)	L (m)	profil	
89462	2.4	15	□	10/120
89463	2.7	15	□	10/120
89464	3.0	12	□	10/120

PL Żyłka tnąca
GB Grass trimmer line
D Mähfaden
RUS Леска для триммера
CZ Struna do strunové sekačky
RO Furtun gradina
H Damil szegélynyíró géphez
E Hilo de cortar



FLO

TRYGON

No.	Ø (mm)	L (m)	profil	
89470	2.4	15	△	10/120
89471	2.7	15	△	10/120
89472	3.0	12	△	10/120

- PL Żyłka tnąca
- GB Grass trimmer line
- D Mähfaden
- RUS Леска для триммера
- CZ Struna do strunového sekačky
- RO Furtun gradina
- H Damil szegélynyíró géphez
- E Hilo de cortar



TRYGON

No.	Ø (mm)	L (m)	profil	☐
89473	2.4	90		10/20
89474	2.7	70		10/20
89475	3.0	60		10/20

- PL Żyłka tnąca
- GB Grass trimmer line
- D Mähfaden
- RUS Леска для триммера
- CZ Struna do strunového sekačky
- RO Furtun gradina
- H Damil szegélynyíró géphez
- E Hilo de cortar



SILENT

No.	Ø (mm)	L (m)	profil	☐
89483	2.0	90		10/20
89484	2.4	90		10/20
89485	2.7	70		10/20
89486	3.0	60		10/20

- PL Rękawice robocze
- GB Working gloves
- D Arbeitshandschuh
- RUS Перчатки
- CZ Pracovní rukavice
- RO Mănuși
- H Védőkesztyű
- E Guantes



No.	pairs / pary	size / rozmiar	☐
74110	1	9	12/300

- PL Rękawice robocze
- GB Working gloves
- D Arbeitshandschuh
- RUS Перчатки
- CZ Pracovní rukavice
- RO Mănuși
- H Védőkesztyű
- E Guantes



No.	size / rozmiar	☐
74126	8	12/300
74132	9	12/300
74133	10	12/300

- PL Żyłka tnąca
- GB Grass trimmer line
- D Mähfaden
- RUS Леска для триммера
- CZ Struna do strunového sekačky
- RO Furtun gradina
- H Damil szegélynyíró géphez
- E Hilo de cortar



SILENT

No.	Ø (mm)	L (m)	profil	☐
89478	1.6	15		20/240
89479	2.0	15		20/240
89480	2.4	15		10/120
89481	2.7	15		10/120
89482	3.0	12		10/120

- PL Rękawice robocze
- GB Working gloves
- D Arbeitshandschuh
- RUS Перчатки
- CZ Pracovní rukavice
- RO Mănuși
- H Védőkesztyű
- E Guantes



No.	☐
74100	12/300

- PL Rękawice robocze
- GB Working gloves
- D Arbeitshandschuh
- RUS Перчатки
- CZ Pracovní rukavice
- RO Mănuși
- H Védőkesztyű
- E Guantes



No.	size / rozmiar	☐
74125	8	12/300
74130	9	12/300
74131	10	12/300

- PL Rękawice robocze
- GB Working gloves
- D Arbeitshandschuh
- RUS Перчатки
- CZ Pracovní rukavice
- RO Mănuși
- H Védőkesztyű
- E Guantes



No.	size / rozmiar	☐
74127	8	12/300
74134	9	12/300
74135	10	12/300

PL Rękawice robocze
GB Working gloves
D Arbeitshandschuh
RUS Перчатки
CZ Pracovní rukavice
RO Mănuși
H Védőkesztyű
E Guantes



FLO

No.	size / rozmiar	
74128	8	12/300
74136	9	12/300
74137	10	12/300

PL Rękawice ogrodnicze
GB Gardening gloves
D Arbeitshandschuh
RUS Перчатки



FLO

No.	size / rozmiar	
74121	8	50/1000

PL Rękawice ogrodnicze
GB Gardening gloves
D Arbeitshandschuh
RUS Перчатки



FLO

No.	size / rozmiar	
74113	8	50/1000

PL Kalosze damskie
GB Women's rain boots
D Damen - Gummistiefel
RUS Галоши женские

CZ Dámské galoše
RO Cizme damă
H Női gumicsizma
E Chanclas para mujer

demar

No.	size / rozmiar	model	
72831	36	LUNA	7
72832	37	LUNA	7
72833	38	LUNA	7
72834	39	LUNA	5
72835	40	LUNA	5
72836	41	LUNA	5

PL Rękawice ogrodnicze
GB Gardening gloves
D Arbeitshandschuh
RUS Перчатки

CZ Pracovní rukavice
RO Mănuși
H Védőkesztyű
E Guantes



FLO

No.	size / rozmiar	
74117	8	50/1000

PL Rękawice ogrodnicze
GB Gardening gloves
D Arbeitshandschuh
RUS Перчатки



FLO

No.	size / rozmiar	
74123	8	50/1000

PL Rękawice ogrodnicze
GB Gardening gloves
D Arbeitshandschuh
RUS Перчатки



FLO

No.	size / rozmiar	
74115	8	50/1000



PL Kalosze męskie
GB Men's rain boots
D Herren - Gummistiefel
RUS Галоши мужские

CZ Pánské galoše
RO Cizme bărbați
H Férfi gumicsizma
E Chanclos para hombre

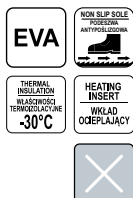

demar

No.	size / rozmiar	model	☐
72840	41	PREDATOR XL	4
72841	42	PREDATOR XL	4
72842	43	PREDATOR XL	4
72843	44	PREDATOR XL	4
72844	45	PREDATOR XL	4
72845	46	PREDATOR XL	4
72846	47	PREDATOR XL	4

PL Kalosze damskie
GB Women's rain boots
D Damen - Gummistiefel
RUS Галоши женские

CZ Dámské galoše
RO Cizme damă
H Női gumicsizma
E Chanclos para mujer



demar

No.	size / rozmiar	model	☐
72850	36	RAINNY BLACK	10
72851	37	RAINNY BLACK	10
72852	38	RAINNY BLACK	10
72853	39	RAINNY BLACK	10
72854	40	RAINNY BLACK	10

PL Wielofunkcyjna podstawka gospodarcza
GB All purpose boot tray
D Garten- & Haushalt-Unterlage
RUS Многофункциональный поднос

CZ Multifunkční podložka
RO Tavă multifuncțională
H Többfunkciós tálcá
E Bandeja de arranque universal



VOREL

No.	mm	☐
67260	780x384x32	30

PL Kalosze męskie
GB Men's rain boots
D Herren - Gummistiefel
RUS Галоши мужские

CZ Pánské galoše
RO Cizme bărbați
H Férfi gumicsizma
E Chanclos para hombre



demar

No.	size / rozmiar	model	☐
72881	40	FARMER	4
72882	41	FARMER	4
72883	42	FARMER	4
72884	43	FARMER	4
72885	44	FARMER	4
72886	45	FARMER	4
72887	46	FARMER	4
72888	47	FARMER	4

PL Kalosze męskie
GB Men's rain boots
D Herren - Gummistiefel
RUS Галоши мужские

CZ Pánské galoše
RO Cizme bărbați
H Férfi gumicsizma
E Chanclos para hombre



demar

No.	size / rozmiar	model	☐
72858	41	GRAND BLACK	8
72859	42	GRAND BLACK	8
72860	43	GRAND BLACK	8
72861	44	GRAND BLACK	8
72862	45	GRAND BLACK	6
72863	46	GRAND BLACK	6
72864	47	GRAND BLACK	6

PL Nakolanniki
GB Knee pads
D Knieeschützer
RUS Наколеники

CZ Chrániče kolen
RO Genunchiere
H Térdvédő
E Rodilleras



No.	☐
74600	50

PL Nakolanniki CZ Chrániče kolen
 GB Knee pads RO Genunchiere
 D Knieschützer H Térdvédő
 RUS Наколенники E Rodilleras



No.	
74610	20

PL Nakolanniki CZ Chrániče kolen
 GB Knee pads RO Genunchiere
 D Knieschützer H Térdvédő
 RUS Наколенники E Rodilleras



No.	
74624	12/24

PL Kask ochronny
 GB Safety helmet
 D Schutzhelm
 RUS Каска защитная
 CZ Ochranná přilba
 RO Cască de protecție
 H Védősisak
 E Casco de protección



No.	colour / kolor	
74190	○	40
74191	●	40
74192	●	40
74193	●	40
74194	●	40
74195	●	40

PL Nakolanniki CZ Chrániče kolen
 GB Knee pads RO Genunchiere
 D Knieschützer H Térdvédő
 RUS Наколенники E Rodilleras



No.	
74622	50

PL Nakolanniki CZ Chrániče kolen
 GB Knee pads RO Genunchiere
 D Knieschützer H Térdvédő
 RUS Наколенники E Rodilleras



No.	
74601	24

PL Nakolanniki CZ Chrániče kolen
 GB Knee pads RO Genunchiere
 D Knieschützer H Térdvédő
 RUS Наколенники E Rodilleras



No.	
74602	6/36

PL Przyłbica z osłoną wymienną
 GB Face shield with PC visor
 D Schweisserschutzhelm mit austauschbarer Abdeckung
 RUS Шлем с заменяемой защитой
 CZ Štít s vyměnitelným krytem
 RO Vizieră cu protecție schimbabilă
 H Arcvédő cserélhető pajzsal
 E Antifaz con protección reemplazable



No.	
74461	40

- PL Przyłbica z osłoną wymienną i nausznikami przeciwhałasowymi
 GB Face shield with steel mesh and ear muff
 D Schweißerschutzhelm mit austauschbarer Abdeckung und Ohrenschützer gegen Lärm
 RUS Шлем с заменяемой защитой и наушниками против шума
 CZ Štit s vyměnitelným krytem a chrániči proti hluku
 RO Vizieră cu protecție schimbabilă și căști de protecție antigomot
 H Arcvédő cserélhető pajzzsal és fülvédő kagylóval
 E Antifaz con protección reemplazable y protectores de oídos



No.	
74462	40

- PL Nauszniki przeciwhałasowe
 GB Ear muff
 D Gehörschutz
 RUS Средства защиты слуха
- CZ Chrániče sluchu
 RO Antifoane
 H Fülvédőt
 E Protectores de la vista



No.	
74581	10/60

- PL Okulary ochronne
 GB Safety glasses
 D Schutzbrille
 RUS Очки защитные открытые
- CZ Ochranné brýle
 RO Ochelari pt. protectie
 H Védőszemüveg
 E Gafas protectoras



No.	type	
74502	HF-110	12/240

- PL Okulary ochronne
 GB Safety glasses
 D Schutzbrille
 RUS Очки защитные открытые
- CZ Ochranné brýle
 RO Ochelari pt. protectie
 H Védőszemüveg
 E Gafas protectoras



No.	type	
74504	DY-8526	15/150

- PL Nauszniki przeciwhałasowe
 GB Ear muff
 D Gehörschutz
 RUS Средства защиты слуха
- CZ Chrániče sluchu
 RO Antifoane
 H Fülvédőt
 E Protectores de la vista



No.	
74580	60

- PL Okulary ochronne
 GB Safety glasses
 D Schutzbrille
 RUS Очки защитные открытые
- CZ Ochranné brýle
 RO Ochelari pt. protectie
 H Védőszemüveg
 E Gafas protectoras



No.	type	
74501	TVS	12/240

- PL Okulary ochronne
 GB Safety glasses
 D Schutzbrille
 RUS Очки защитные открытые
- CZ Ochranné brýle
 RO Ochelari pt. protectie
 H Védőszemüveg
 E Gafas protectoras



No.	type	
74503	DY-8525	15/150

- PL Okulary ochronne
 GB Safety glasses
 D Schutzbrille
 RUS Очки защитные открытые
- CZ Ochranné brýle
 RO Ochelari pt. protectie
 H Védőszemüveg
 E Gafas protectoras



No.	type	
74508	HF-103	10/120

PL Okulary ochronne
GB Safety glasses
D Schutzbrille
RUS Очки защитные открытые

CZ Ochranné brýle
RO Ochelari pt. protectie
H Védőszemüveg
E Gafas protectoras



VOREL

No.	type	type	type
74509	HF-105		10/100

PL Obrzeże trawnikowe, zielone
GB Lawn edge
D Gartenumrandung
RUS Оградка для огорода

CZ Plastový okraj trávníku
RO Gărdut plastic grădină
H Ágyásszegély
E Borde para jardín



FLO

No.	width / szerokość (mm)	L (m)	type
88700	100	9	24
88701	150	9	18
88702	200	9	12

PL Obrzeże trawnikowe, brązowe
GB Lawn edge
D Gartenumrandung
RUS Оградка для огорода

CZ Plastový okraj trávníku
RO Gărdut plastic grădină
H Ágyásszegély
E Borde para jardín



FLO

No.	width / szerokość (mm)	L (m)	type
88703	100	9	24
88704	150	9	18
88705	200	9	12

PL Drut ogrodniczy powlekany z obcinaczem
GB Twist tie with cutter
D Gartendraht, beschichtet, mit Abschneider
RUS Проволока огородная с диспенсером

CZ Drát pro zahrádkáře potažený plastem s odzěvačem
RO Sărmă pt. grădină izolată cu tăietor
H Galvanizált kötöződrót, darabolóval
E Alambre de jardinero cubierto con tronizador



FLO

No.	L (m)	type	type
88805	30		24/144
88806	50		24/144

PL Spodnie ogrodnicze
GB Garden trousers
D Gartenhosen
RUS Брюки садовые

CZ Zahradnické kalhoty
RO Pantaloni pt. grădinărit
H Kertész nadrág
E Pantalón de jardinería

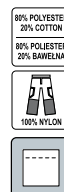

FLO

No.	size / rozmiar	type	type
72900	S		10
72901	M		10
72902	L		10
72903	XL		10

PL Drut ogrodniczy
GB Twist tie
D Gartendraht
RUS Проволока огородная

CZ Drát pro zahrádkáře
RO Sărmă pt. grădină
H Kötöződrót
E Alambre de jardinero

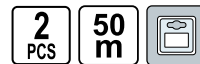

FLO

No.	L (m)	type	type
88801	50		12/48

PL Drut ogrodniczy w oslonie z pianki
GB Garden flexible tie
D Gartendraht, in einer Abdeckung aus Schaumstoff
RUS Проволока огородная покрытая пенкой

CZ Drát pro zahrádkáře s pěnovým pláštěm
RO Sărmă pt. grădină cu izolație din spumă
H Kötöződrót, plasztik bevonattal
E Alambre de jardinero en cubierta de espuma



FLO

No.	L (m)	type	type
88809	10		40

- PL Zestaw ogrodniczy do podwiązywania roślin
- GB Plant binding set
- D Gartensatz zum Abbinden von Pflanzen
- RUS Набор огородный для подвязки растений
- CZ Souprava pro zahrádkáře k vyvazování rostlin
- RO Set pt. grădină pt. legare plante
- H Kertészeti szett növények felkötéséhez
- E Juego para jardín para sujetar plantas

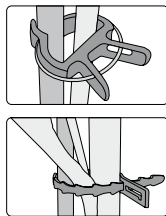

71
PCS



No.	pcs	☐
88811	71	24

- PL Kosz ogrodniczy
- GB Garden basket
- D Gartenkorb
- RUS Корзина садовая
- CZ Zahradní koš
- RO Coș de grădină
- H Kerti kosár
- E Cesta de jardín



No.	l	☐
35610	25	480
35611	35	280

- PL Wiadro ocynkowane
- GB Galvanized bucket
- D Baueimer
- RUS Ведро
- CZ Vědro
- RO Găleată
- H Kőműves vödör
- E Cubo



No.	l	☐
89560	5	900
89561	7	450
89562	10	600
89563	12	500
89564	15	400

- PL Worki ogrodowe
- GB Garden bags
- D Gartensäcke
- RUS Мешки для огорода
- CZ Zahradní pytle
- RO Saci gunoi pt. gradina
- H Kerti szemeteszák
- E Bolsas de jardín



No.	l	pcs packing	µm	☐
09481	120	10	60	15

- PL Miernik ogrodniczy
- GB Soil survey instrument
- D Gartenmessgerät
- RUS Измеритель огородный
- CZ Zahradnický měřicí přístroj
- RO Aparat de măsurat grădinăresc
- H Négyfunkciós, kerti mérőműszer
- E Medidor de horticultor

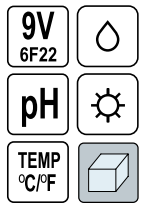

No.	☐
89000	10

- PL Wiadro ogrodnicze
- GB Garden bucket
- D Garten Eimer
- RUS Ведро огородное

- CZ Zahradní vědro
- RO Găleată de grădină
- H Kerti vödör
- E Cubo de jardín



No.	l	☐
35600	15	500

- PL Wiadro budowlane
- GB Plastic bucket
- D Baueimer
- RUS Ведро строительное
- CZ Stavební vědro
- RO Găleată pt. construcții
- H Kőműves vödör
- E Cubo de obra



No.	l	☐
06388	10	900
06390	12	680
06393	16	450
06392	20	390

- PL Worki ogrodowe z taśmą
- GB Garden bags with cord
- D Gartensäcke mit Band
- RUS Мешки для огорода с лентой

- CZ Zahradní pytle zatahovací
- RO Saci gunoi pt. gradina cu strangere
- H Szalagos kerti szemeteszák
- E Bolsas de jardín con cinta



No.	l	pcs packing	µm	☐
09480	60	10	60	12
09482	120	10	60	15

- PL Worki perforowane na trawę
 GB Waste bags for grass
 D Gartenmüllsäcke perforiert
 RUS Мусорные пакеты прочные для листьев
- CZ Perforované odpadové pytle na trávu
 RO Sac gunoi pt. iarba
 H Szalagos kerti szemeteszák
 E Sacos perforadas para residuos de jardín

PERFORATED
 PERFORANY

LDPE



No.	l	pcs packing	µm	☐
09483	120	10	35	25

- PL Drabina wielofunkcyjna
 GB Multifold ladder
 D Mehrzweckleiter
 RUS Многофункциональная стремянка
- CZ Multifunkční žebřík
 RO Scară multifuncțională
 H Többcéllú létra
 E Escalera multipropósito

3.8 m max
 STEPS STOPNIE x13

Al NYLON

max 150 kg

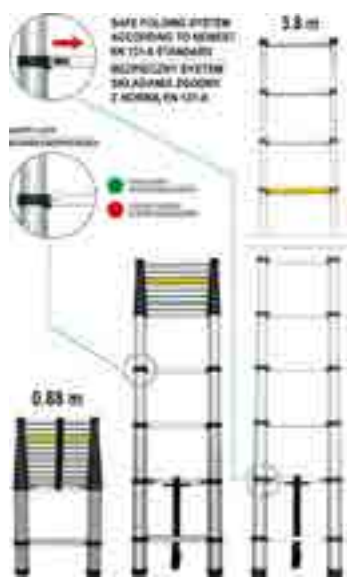
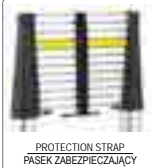

No.	☐
17701	1

- PL Worki perforowane na liście
 GB Perforated waste bags for leaves
 D Gartenmüllsäcke perforiert
 RUS Мусорные пакеты прочные для листьев
- CZ Perforované odpadové pytle na listy
 RO Szalagos kerti szemeteszák
 H Sac gunoi perforat pt. frunze
 E Sacos perforadas para residuos de jardín

PERFORATED
 PERFORANY

LDPE



No.	l	pcs packing	µm	☐
09484	200	10	40	12

- PL Drabina wielofunkcyjna
 GB Multifold ladder
 D Mehrzweckleiter
 RUS Лестница многофункциональная
- CZ Multifunkční žebřík
 RO Scară multifuncțională
 H Többcéllú létra
 E Escalera multipropósito

3.4 m max

STEPS STOPNIE 4x3

16 kg

max 150 kg



No.	☐
17704	1



- PL Podest do drabiny wielofunkcyjnej
- GB Multifunction ladder platform
- D Podest für die Multifunktionale Leiter
- RUS Настил для лестницы трансформера
- CZ Plošina pro víceúčelový žebřík
- RO Platformă pt. scară multifuncțională
- H Palló a multifunkciós létrához
- E Descansillos para la escala multifuncional

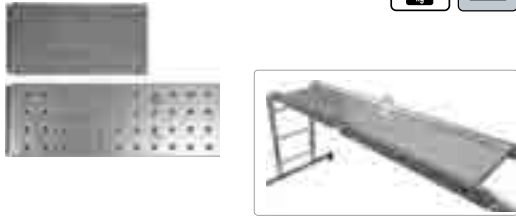

No.	for / dla	☐
17705	17704	5

- PL Kompostownik
- GB Composter
- D Kompostierer
- RUS Компостовник
- CZ Kompostér
- RO Compostor
- H Komposztáló láda
- E Compostador



No.	l	☐
35620	420	10

- PL Kompostownik
- GB Composter
- D Kompostierer
- RUS Компостовник
- CZ Kompostér
- RO Compostor
- H Komposztáló láda
- E Compostador



No.	l	☐
35622	880	6

- PL Sito do kompostu i żwiru
- GB Compost and gravel sieve
- D Sieb für Kompost und Kies
- RUS Сито для компоста и гравия
- CZ Prohazovací síto na kompost a štěrk
- RO Cedazo para estiércol y guija
- H Sitő kompost și zgură
- E Rosta komposztáláshoz és sóderhez



No.	cm	size of eyelet / rozmiar oczka (mm)	☐
34949	60x100	20	5/30

- PL Kompostownik
- GB Composter
- D Kompostierer
- RUS Компостовник
- CZ Kompostér
- RO Compostor
- H Komposztáló láda
- E Compostador



No.	l	☐
35621	650	7

- PL Siatka zabezpieczająca rynny
- GB Gutter mesh
- D Schutzgitter für Rinnen
- RUS Защитная сетка желоба
- CZ Ochranná síť proti zanášení okapových žlabů
- RO Plasă de protecție burlane
- H Lombfogó háló
- E Malla de protección para la canaleta



No.	☐
69850	30

- PL Siatka zabezpieczająca rynny z uchwytami mocującymi
- GB Gutter mesh with hooks
- D Schutzgitter für Rinnen mit Spannvorrichtungen
- RUS Защитная сетка желоба с монтажными ручками
- CZ Ochranná síť proti zanášení okapových žlabů s úchytkami
- RO Plasă de protecție burlane cu suporturi de protecție
- H Lombfogó háló rögzítő fűlekkel
- E Malla de protección para la canaleta con mandriles de sujeción



No.	☐
69851	30

- PL Przedłużacz CZ Prodluzovací kabel zahradní
 GB Garden extension cable RO Prelungitor electric
 D Gartenverlängerungskabel H Kerti hosszabbító
 RUS Электродлинитель E Cable de extensión para jardín

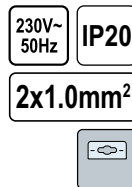

No.	L (m)	☐
82671	10	10
82673	20	10
82675	30	5

- PL Grill gazowy CZ Plynový gril
 GB Gas BBQ grill RO Grătarul cu gaz
 D Der Gasgrill H Gázgrill
 RUS Газовый гриль E Barbacoa de gas



BBO GRILL FOR LPG GRILL GAZOWY LPG
 3 MAIN BURNERS 3 PALNIKI GŁÓWNE
 CONNECTION SET INCLUDED WĄŻ I REGULATOR W ZESTAWIE
 IGNITION IN THE KNOB ZAPALNIK W POKRĘTLE
 GRILL SIZE / ROZMIAR RUSZTU 54 x 40 cm
 1 SIDE BURNER 3 PALNIK BOCZNY
 THERMO GAUGE TERMOMETR
 SLIDING TRAY FOR WASTED FAT WYSUWANA TACA NA TŁUSZCZ



No.	☐
99640	1

- PL Grill ogrodowy z termometrem
 GB Big barrel BBQ with thermo gauge
 D BBQ Grillwagen XXL mit Temperaturanzeige
 RUS Барбекю-коптильня с термометром
 CZ Zahradní udírna s grilem
 RO Grătar cu afumătoare si termometru
 H Kültéri faszenes grill
 E Barbacoa Grill de carbón con soporte



No.	☐
99512	1

- PL Grill gazowy CZ Plynový gril
 GB Gas BBQ grill RO Grătarul cu gaz
 D Der Gasgrill H Gázgrill
 RUS Газовый гриль E Barbacoa de gas



BBO GRILL FOR LPG GRILL GAZOWY LPG
 4 MAIN BURNERS 4 PALNIKI GŁÓWNE
 CONNECTION SET INCLUDED WĄŻ I REGULATOR W ZESTAWIE
 IGNITION IN THE KNOB ZAPALNIK W POKRĘTLE
 WHEELS WITH A BRAKE KOLEJA Z HAMULCEM
 GRILL SIZE / ROZMIAR RUSZTU 64 x 40 cm
 1 SIDE BURNER 3 PALNIK BOCZNY
 SIDE HANDLES UCHWYTY BOCZNE
 THERMO GAUGE TERMOMETR
 SLIDING TRAY FOR WASTED FAT WYSUWANA TACA NA TŁUSZCZ



No.	☐
99641	1

- PL Grill ogrodowy z termometrem i wędzarnią
 GB Big barrel BBQ with smoker
 D BBQ Grillwagen mit Temperaturanzeige und Räucherei
 RUS Барбекю-коптильня с термометром
 CZ Zahradní udírna s grilem
 RO Grătar cu afumătoare si termometru
 H Kültéri faszenes grill
 E Barbacoa Grill de carbón con soporte



No.	☐
99513	1

- PL Grill ogrodowy z termometrem
- GB Big barrel BBQ with thermo gauge
- D BBQ Grillwagen XXL mit Temperaturanzeige
- RUS Барбекю-коптильня с термометром
- CZ Zahradní udrina s grilem
- RO Grătar cu afumătoare si termometru
- H Kültéri faszénes grill
- E Barbacoa Grill de carbón con soporte



No.
99514



- PL Grill węglowy
- GB Charcoal BBQ grill
- D Holzkohlegrill
- RUS Гриль-барбекю угольный
- CZ Gril na dřevěné uhlí
- RO Gratar carbuni
- H Faszén grill
- E Barbacoa de carbón y lena



GRILL ADJUSTMENT SYSTEM
SYSTEM REGULACJI RUSZTU

SIDE SHELF
PÓLKA BOCZNA

GRILL SIZE / ROZMIAR RUSZTU
81 x 39 cm

BBQ SPIT HINGE
MIECZKA NA ROŻEN



No.
99520



- PL Grill węglowy
- GB Charcoal BBQ grill
- D Holzkohlegrill
- RUS Гриль-барбекю угольный
- CZ Gril na dřevěné uhlí
- RO Gratar carbuni
- H Faszén grill
- E Barbacoa de carbón y lena



GRILL ADJUSTMENT SYSTEM
SYSTEM REGULACJI RUSZTU

GRILL LID / KAPAK
KRYDZKA

GRILL SIZE / ROZMIAR RUSZTU
47 x 47 cm

2 POSITION SPIT
2-POZYCYJNY MIECZKA

AIR FLOW
OBIEG POWIETRZA



No.
99581



- PL Grill węglowy
- GB Charcoal BBQ grill
- D Holzkohlegrill
- RUS Гриль-барбекю угольный
- CZ Gril na dřevěné uhlí
- RO Gratar carbuni
- H Faszén grill
- E Barbacoa de carbón y lena



HARCOAL BBQ GRILL
GRILL WĘGLOWY

GRILL SIZE / ROZMIAR RUSZTU
72 x 39 cm

2 ADJUSTABLE GRILLS
2 REGULOWANE RUSZTY

No.
99519



- PL Grill węglowy
- GB Charcoal BBQ grill
- D Holzkohlegrill
- RUS Гриль-барбекю угольный
- CZ Gril na dřevěné uhlí
- RO Gratar carbuni
- H Faszén grill
- E Barbacoa de carbón y lena



HARCOAL BBQ GRILL
GRILL WĘGLOWY

METAL SHELF
METALOWA PÓLKA

GRILL SIZE / ROZMIAR RUSZTU
47 x 47 cm

AIR FLOW
OBIEG POWIETRZA



No.
99580



- PL Grill węglowy
- GB Charcoal BBQ grill
- D Holzkohlegrill
- RUS Гриль-барбекю угольный
- CZ Gril na dřevěné uhlí
- RO Gratar carbuni
- H Faszén grill
- E Barbacoa de carbón y lena



GRILL ADJUSTMENT SYSTEM
SYSTEM REGULACJI RUSZTU

GRILL LID / KAPAK
KRYDZKA

GRILL SIZE / ROZMIAR RUSZTU
47 x 47 cm

2 POSITION SPIT
2-POZYCYJNY MIECZKA

AIR FLOW
OBIEG POWIETRZA



No.
99584



- PL Grill wiszący na trójnożu
- GB Round chain grill
- D Dreibockhängegrill
- RUS Подвесной гриль на треноге
- CZ Závěsný gril na trójnožce
- RO Gratar pe lant / trepid
- H Állványos függő grill
- E Parrilla colgante con trípode

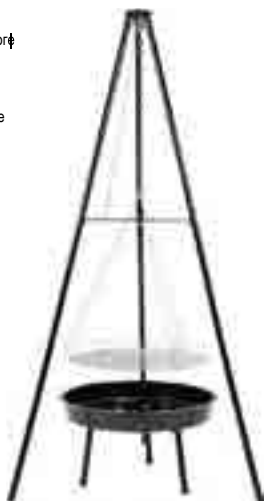

70x152
x70 cm

30-67 cm
COOKING HEIGHT
REGULOWANA
WYSOKOŚĆ PŁYTY

Ø52 cm
BOWL / MISA



No. 99524 1

- PL Palenisko ogrodowe
- GB Cast iron fire pit
- D Gartenfeuerstätte
- RUS Садовый очаг
- CZ Zahradní ohniště
- RO Gratar tip vatra
- H Kerti tűzrakó
- E Fogón para jardín



CAST IRON
FIRE BOWL
ZELIWNIA
MISKA

60x33
cm

Ø60 cm
BOWL / MISA



No. 99711 1

- PL Widelec ogniskowy
- GB Rake handle
- D Lagerfeuerspies
- RUS Шампур-вилка для гриля
- CZ Vidička na opékání
- RO Furculita / tepusa
- H Grillvilla
- E Tenedor de fuego



No. 99568 98 10/100

- PL Palenisko ogrodowe
- GB Cast iron fire pit
- D Gartenfeuerstätte
- RUS Садовый очаг
- CZ Zahradní ohniště
- RO Gratar tip vatra
- H Kerti tűzrakó
- E Fogón para jardín



60x33
cm

220 mm
DEPTH OF THE BOWL
GŁĘBOKOŚĆ MISKI

CAST IRON
FIRE BOWL
ZELIWNIA
MISKA

Ø60 cm
BOWL / MISA



No. 99710 1

- PL Palenisko ogrodowe
- GB Cast iron fire pit
- D Gartenfeuerstätte
- RUS Садовый очаг
- CZ Zahradní ohniště
- RO Gratar tip vatra
- H Kerti tűzrakó
- E Fogón para jardín



67 x 59
x26 cm

Ø59 cm
BOWL / MISA



No. 99712 1

- PL Widelec ogniskowy
- GB Rake handle
- D Lagerfeuerspies
- RUS Шампур-вилка для гриля
- CZ Vidička na opékání
- RO Furculita / tepusa
- H Grillvilla
- E Tenedor de fuego



No. 99575 120 60

24

Sanitary ware & hydraulics
Armatura sanitarna i hydraulika



Mixers, faucets
Baterie

.....394-399

**Linear drains**
Odpływy liniowe

.....399-400

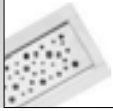
**Water regulators**
Reduktory przepływu wody

.....400-401

**Pop-up wastes**
Korki automatyczne

.....401-402

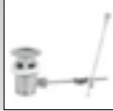
**Shower handles**
Słuchawki prysznicowe

.....402-406

**Shower & connecting hoses**
Wężę prysznicowe i przyłączeniowe

.....406-409

**Bathroom & shower sets**
Komplety łazienkowe i prysznicowe

.....409-410

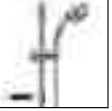
**Bathroom accessories**
Akcesoria łazienkowe

.....410-416

**Toilet seats**
Deski toaletowe

.....416-417

**Plastic stools**
Stołki plastikowe

.....417

**Hydraulic accessories**
Akcesoria hydrauliczne

.....417-419



The exclusive composition with sapphire hardness developed by famous spanish company.

Głowica z wkładem ceramicznym o twardości szafiru renomowanego hiszpańskiego producenta.



CORUNDOx

Mixing water flow with intake air reduces consumption by half, without splashing.

Zmieszany strumień wody z zasysanym powietrzem oszczędza zużycie o połowę i nie chlapie.



ECOflow

The most effective way to save water and energy - flowing only cold water when the lever is centered.

Najefektywniejszy sposób oszczędzania wody i energii - dla uchwytu usytuowanego na wprost popłynie tylko zimna woda.



ECOstart

Nano-size cavities on the disc surface to keep the lubrication, provides a higher durability and an improved smooth feeling.

Mikrozagłębienia dzięki którym smar w głowicy nie wypłykuje się i głowica działa gładko przez wiele lat.



NANOCave

Rubbing the lime away with a finger and the stream is like in brand new faucet again.

Przetarcie palcem usuwa kamień i przywraca strumień jak w nowej baterii.



SMARTclean

Reduced noise thanks to silencer in eccentric wall connector.

Obniżony hałas dzięki użyciu tłumików w złączach.



LOWnoise

Ergonomic faucet provides more space for comfortable using.

Ergonomiczna bateria zapewniająca przestrzeń dla wygodnego użytkownika.



ERGOsize

Simple and effective installation thanks to the large nut that screw without any tools.

Łatwy i trwały montaż dzięki dużej nakrętce, którą przykręcisz bez użycia jakiegokolwiek narzędzia.



SMARTnut

Improved lime protection: integrated honeycomb structure replaces conventional wire mesh screens prone to lime build-up.

Lepsza ochrona przeciwkapienna: struktura plastra miodu zastępuje klasyczne wkłady siateczkowe, które mają tendencję do zarastania.

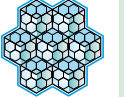

HEXAGONal

Body without holes and nooks that could accumulate dirt and microorganisms.

Korpus bez otworów i zakamarków, które gromadzą brud i mikroorganizmy.



CLEANbody

Innovative mounting system for hose nut and safe servicing aerator.

Innowacyjny system montażu wężyków i bezpiecznego serwisowania aeratora.



SMARTtool

Multi-purpose hydraulic wrench for installation of faucet and small plumbing work.

Wielofunkcyjny klucz hydrauliczny do montażu baterii i drobnych prac hydraulicznych.



SMARTtool

- PL Bateria umywalkowa
- GB Basin mixer
- D Einhand-Waschtischbatterie
- RUS Смеситель для раковины
- CZ Umyvadlová baterie
- RO Baterie lavoar
- H Mosdó csaptelep
- E Monomando de lavabo



FALA

No.	series / seria	
75740	TARRAGONA	10

- PL Bateria prysznicowa
- GB Single-lever shower mixer
- D Einhand-Brausebatterie
- RUS Смеситель для душа
- CZ Sprchová baterie
- RO Baterie dus
- H Egykaros zuhanycsaptelep
- E Monomando de ducha



FALA

No.	series / seria	
75743	TARRAGONA	10

- PL Bateria wannowa
- GB Bath mixer
- D Einhand-Wannenbatterie
- RUS Смеситель для ванны
- CZ Vanové baterie
- RO Baterie cada / dus
- H Egykaros kádcsaptelep
- E Monomando para bañoo

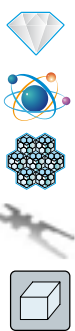

FALA

No.	series / seria	
75742	TARRAGONA	8

- PL Bateria umywalkowa
- GB Basin mixer
- D Einhand-Waschtischbatterie
- RUS Смеситель для раковины
- CZ Umyvadlová baterie
- RO Baterie lavoar
- H Mosdó csaptelep
- E Monomando de lavabo

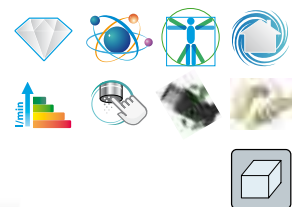

FALA

No.	series / seria	
75770	ALICANTE	10

- PL Bateria wannowa
- GB Bath mixer
- D Einhand-Wannenbatterie
- RUS Смеситель для ванны
- CZ Vanové baterie
- RO Baterie cada / dus
- H Egykaros kádcsaptelep
- E Monomando para baño

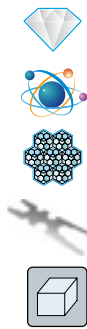

FALA

No.	series / seria	Icon
75772	ALICANTE	8

- PL Bateria zlewozmywakowa
- GB Single-lever sink mixer
- D Einhand-Spültischbatterie
- RUS Смеситель для раковины
- CZ Dřezová baterie
- RO Baterie stativă bucătărie
- H Mosogató csaptelep
- E Monomando de fregadero



FALA

No.	series / seria	Icon
75774	ALICANTE	8

- PL Bateria wannowa
- GB Bath mixer
- D Einhand-Wannenbatterie
- RUS Смеситель для ванны
- CZ Vanové baterie
- RO Baterie cada / dus
- H Egykaros kádcsaptelep
- E Monomando para baño

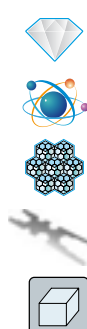

FALA

No.	series / seria	Icon
75762	SORIA	8

- PL Bateria prysznicowa
- GB Single-lever shower mixer
- D Einhand-Brausebatterie
- RUS Смеситель для душа
- CZ Sprchová baterie
- RO Baterie dus
- H Egykaros zuhanycsaptelep
- E Monomando de ducha



FALA

No.	series / seria	Icon
75773	ALICANTE	10

- PL Bateria umywalkowa
- GB Basin mixer
- D Einhand-Waschtischbatterie
- RUS Смеситель для раковины
- CZ Umyvadlová baterie
- RO Baterie lavoar
- H Mosdó csaptelep
- E Monomando de lavabo



FALA

No.	series / seria	Icon
75760	SORIA	10

- PL Bateria prysznicowa
- GB Single-lever shower mixer
- D Einhand-Brausebatterie
- RUS Смеситель для душа
- CZ Sprchová baterie
- RO Baterie dus
- H Egykaros zuhanycsaptelep
- E Monomando de ducha



FALA

No.	series / seria	Icon
75763	SORIA	10

- PL Bateria zlewozmywakowa
- GB Single-lever sink mixer
- D Einhand-Spültischbatterie
- RUS Смеситель для кухни
- CZ Dřezová baterie
- RO Baterie stativă bucatărie
- H Mosogató csaptelep
- E Monomando de fregadero



FALA

No.	series / seria	8
75764	SORIA	8

- PL Bateria wannowa
- GB Bath mixer
- D Einhand-Wannenbatterie
- RUS Смеситель для ванны
- CZ Vanové baterie
- RO Baterie cada / dus
- H Egykaros kádcsaptelep
- E Monomando para baño



FALA

No.	series / seria	8
75767	MURCIA	8

- PL Bateria umywalkowa
- GB Basin mixer
- D Einhand-Waschtischbatterie
- RUS Смеситель для раковины
- CZ Umyvadlová baterie
- RO Baterie lavoar
- H Mosdó csaptelep
- E Monomando de lavabo



FALA

No.	series / seria	10
75745	BURGOS	10

- PL Bateria umywalkowa
- GB Basin mixer
- D Einhand-Waschtischbatterie
- RUS Смеситель для раковины
- CZ Umyvadlová baterie
- RO Baterie lavoar
- H Mosdó csaptelep
- E Monomando de lavabo



FALA

No.	series / seria	10
75765	MURCIA	10

- PL Bateria prysznicowa
- GB Single-lever shower mixer
- D Einhand-Brausebatterie
- RUS Смеситель для душа
- CZ Sprchová baterie
- RO Baterie dus
- H Egykaros zuhanycsaptelep
- E Monomando de ducha



FALA

No.	series / seria	10
75768	MURCIA	10

- PL Bateria wannowa
- GB Bath mixer
- D Einhand-Wannenbatterie
- RUS Смеситель для ванны
- CZ Vanové baterie
- RO Baterie cada / dus
- H Egykaros kádcsaptelep
- E Monomando para baño



FALA

No.	series / seria	8
75747	BURGOS	8

- PL Bateria prysznicowa
- GB Single-lever shower mixer
- D Einhand-Brausebatterie
- RUS Смеситель для душа
- CZ Sprchová baterie
- RO Bateria dus
- H Egykaros zuhanysaptelep
- E Monomando de ducha



FALA

No.	series / seria	box
75748	BURGOS	10

- PL Bateria umywalkowa
- GB Basin mixer
- D Einhand-Waschtischbatterie
- RUS Смеситель для раковины
- CZ Umyvadlová baterie
- RO Bateria lavoar
- H Mosdó csaptelep
- E Monomando de lavabo



No.	box
75685	12

- PL Bateria prysznicowa
- GB Single-lever shower mixer
- D Einhand-Brausebatterie
- RUS Смеситель для душа
- CZ Sprchová baterie
- RO Bateria dus
- H Egykaros zuhanysaptelep
- E Monomando de ducha



No.	box
75687	12

- PL Bateria zlewozmywakowa
- GB Single-lever sink mixer
- D Einhand-Spültischbatterie
- RUS Смеситель для кухни
- CZ Dřezová baterie
- RO Bateria stativă bucătărie
- H Mosogató csaptelep
- E Monomando de fregadero



FALA

No.	series / seria	box
75749	BURGOS	8

- PL Bateria wannowa
- GB Bath mixer
- D Einhand-Wannenbatterie
- RUS Смеситель для ванны
- CZ Vanové baterie
- RO Bateria cada / dus
- H Egykaros kádcsaptelep
- E Monomando para baño



No.	box
75686	12

- PL Bateria umywalkowa ścienna
- GB Basin mixer
- D Einhand-Waschtischbatterie
- RUS Смеситель для раковины
- CZ Umyvadlová baterie
- RO Bateria lavoar
- H Mosdó csaptelep
- E Monomando de lavabo



No.	box
75688	12

- PL Bateria zlewozmywakowa
- GB Single-lever sink mixer
- D Einhand-Spültischbatterie
- RUS Смеситель для кухни
- CZ Dřezová baterie
- RO Baterie stativă bucătărie
- H Mosogató csaptelep
- E Monomando de fregadero

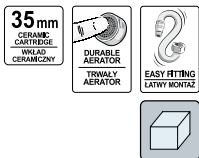

No.		
75689		12

- PL Bateria zlewozmywakowa
- GB Single-lever sink mixer
- D Einhand-Spültischbatterie
- RUS Смеситель для кухни
- CZ Dřezová baterie
- RO Baterie stativă bucătărie
- H Mosogató csaptelep
- E Monomando de fregadero



Flexible spout allows for any shaping.
Elastyczna wylewka umożliwia dowolne kształtowanie.

No.	series / seria	
75706	FLEXIBLE-WHITE	10

- PL Bateria zlewozmywakowa
- GB Single-lever sink mixer
- D Einhand-Spültischbatterie
- RUS Смеситель для кухни
- CZ Dřezová baterie
- RO Baterie stativă bucătărie
- H Mosogató csaptelep
- E Monomando de fregadero



Flexible spout allows for any shaping.
Elastyczna wylewka umożliwia dowolne kształtowanie.

No.	series / seria	
75708	FLEXIBLE-ORANGE	10

- PL Bateria zlewozmywakowa
- GB Single-lever sink mixer
- D Einhand-Spültischbatterie
- RUS Смеситель для кухни
- CZ Dřezová baterie
- RO Baterie stativă bucătărie
- H Mosogató csaptelep
- E Monomando de fregadero



Flexible spout allows for any shaping.

Elastyczna wylewka umożliwia dowolne kształtowanie.

No.	series / seria	
75705	FLEXIBLE-BLACK	10

- PL Bateria zlewozmywakowa
- GB Single-lever sink mixer
- D Einhand-Spültischbatterie
- RUS Смеситель для кухни
- CZ Dřezová baterie
- RO Baterie stativă bucătărie
- H Mosogató csaptelep
- E Monomando de fregadero



Flexible spout allows for any shaping.

Elastyczna wylewka umożliwia dowolne kształtowanie.

No.	series / seria	
75707	FLEXIBLE-RED	10

- PL Bateria zlewozmywakowa
- GB Single-lever sink mixer
- D Einhand-Spültischbatterie
- RUS Смеситель для кухни
- CZ Dřezová baterie
- RO Baterie stativă bucătărie
- H Mosogató csaptelep
- E Monomando de fregadero



Flexible spout allows for any shaping.

Elastyczna wylewka umożliwia dowolne kształtowanie.

No.	series / seria	
75709	FLEXIBLE-GREEN	10

- PL Perlator i zestaw uszczelek do baterii
 GB Aerator and sealing set for sanitary mixers
 D Strahlregler- und Dichtungsgummissatz für Armatur
 RUS Аэратор с набором прокладок для смесителя
- CZ Perlátor a sada těsnění do baterie
 RO Sita și garnitură pt. baterii sanitare
 H Levegőtető és tömítógumi készlet csaptelephez
 E Aireado y juego de juntas



FALA

No.	
75327	25/200

<p>Special inlay et ion window for 100% outflow control and comfortable cleaning.</p> <p>Specjalne okienko rewizyjne to 100% kontroli drożności i wygodne czyszczenie.</p> <p>SMARTthru</p>	<p>Easy to clean thanks to obtained hook</p> <p>Łatwy do utrzymania w czystości dzięki dołączonemu haczykowi.</p> <p>EASYclean</p>	<p>Stabilizing body grips additional stiffening in the floor.</p> <p>Uchwyty stabilizujące korpus. Dodatkowo usztywnienie konstrukcji w podłodze.</p> <p>GRIPstrong</p>
<p>Waterproof cloth included – as essential part of waterproofing.</p> <p>Mata uszczelniająca w zestawie – niezbędna część przy wykonywaniu hydroizolacji.</p> <p>HYDRocloth</p>	<p>Effective and durable rainwater whip prevents clogging of the trap and makes cleaning easier.</p> <p>Skuteczne i trwałe sito, które zapobiega zapychaniu syfonu oraz ułatwia bieżącą obsługę odpływu.</p> <p>STRAINer</p>	<p>High quality precision welds guarantee no leaking of the drain.</p> <p>Wysokiej jakości precyzyjne spawy gwarantujące szczelność odpływu.</p> <p>HQwelding</p>
<p>Low siphon made of stainless steel AISI 304 makes installation easier.</p> <p>Niski syfon wykonany ze stali nierdzewnej AISI 304 ułatwiający instalację.</p> <p>52 mm EXTRASlim</p>	<p>Wide range of height adjustment allows adjusting to the floor level.</p> <p>Szeroki zakres regulacji wysokości, który umożliwia dopasowanie odpływu do powierzchni posadzki.</p> <p>EASYfix</p>	<p>It can prevent stink and worms both in use and after dry (no water in siphon).</p> <p>Zapobiega przedostawaniu się zapachów oraz robaków podczas używania jak i po wysuszeniu (brak wody w syfonie).</p> <p>WET&DRY</p>

- PL Odpływ liniowy
 GB Linear drain
 D Duschrinne
 RUS Душевой лоток
- CZ Odtokový žlab
 RO Rigola dus
 H Zuhanyfolyóka
 E Canal de ducha



FALA

No.	L (cm)	series / seria	
75360	30	MADEIRA	6
75361	40	MADEIRA	6
75362	50	MADEIRA	6
75363	60	MADEIRA	6
75364	70	MADEIRA	6
75365	80	MADEIRA	6
75366	90	MADEIRA	6

- PL Odpływ liniowy
 GB Linear drain
 D Duschrinne
 RUS Душевой лоток
- CZ Odtokový žlab
 RO Rigola dus
 H Zuhanyfolyóka
 E Canal de ducha



- PL Odpływ liniowy
 GB Linear drain
 D Duschrinne
 RUS Душевой лоток
- CZ Odtokový žlab
 RO Rigola dus
 H Zuhanyfolyóka
 E Canal de ducha



FALA

No.	L (cm)	series / seria	
75367	30	TOCANTINS	6
75368	40	TOCANTINS	6
75369	50	TOCANTINS	6
75370	60	TOCANTINS	6
75371	70	TOCANTINS	6
75372	80	TOCANTINS	6
75373	90	TOCANTINS	6

FALA

No.	L (cm)	series / seria	
75374	30	NAPO	6
75375	40	NAPO	6
75376	50	NAPO	6
75377	60	NAPO	6
75378	70	NAPO	6
75379	80	NAPO	6
75380	90	NAPO	6



PL Odpływ liniowy CZ Odtokowy żłab
 GB Linear drain RO Rigola dus
 D Duschrinne H Zuhanyfolyóka
 RUS Душевой лоток E Canal de ducha



FALA

No.	L (cm)	series / seria	
75381	60	WHITE GLASS	6
75382	70	WHITE GLASS	6
75383	80	WHITE GLASS	6
75384	90	WHITE GLASS	6

PL Odpływ liniowy CZ Odtokowy żłab
 GB Linear drain RO Rigola dus
 D Duschrinne H Zuhanyfolyóka
 RUS Душевой лоток E Canal de ducha



FALA

No.	L (cm)	series / seria	
75421	60	OLIMP	6
75422	70	OLIMP	6
75423	80	OLIMP	6
75424	90	OLIMP	6

PL Reduktor przepływu wody
 GB Water flow rate reducer
 D Wassersparer
 RUS Регулятор расхода воды
 CZ Regulátor toku vody
 RO Reductor de debit de apă
 H Áramlás korlátozó
 E Regulador de flujo de agua

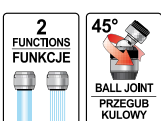

FALA

No.	
75328	20/120

PL Odpływ liniowy CZ Odtokowy żłab
 GB Linear drain RO Rigola dus
 D Duschrinne H Zuhanyfolyóka
 RUS Душевой лоток E Canal de ducha



FALA

No.	L (cm)	series / seria	
75386	60	BLACK GLASS	6
75387	70	BLACK GLASS	6
75388	80	BLACK GLASS	6
75389	90	BLACK GLASS	6

PL Odpływ liniowy CZ Odtokowy żłab
 GB Linear drain RO Rigola dus
 D Duschrinne H Zuhanyfolyóka
 RUS Душевой лоток E Canal de ducha



FALA

No.	L (cm)	series / seria	
75448	60	LINE	6
75449	70	LINE	6
75450	80	LINE	6
75451	90	LINE	6

PL Reduktor przepływu wody
 GB Water flow rate reducer
 D Wassersparer
 RUS Регулятор расхода воды
 CZ Regulátor toku vody
 RO Reductor de debit de apă
 H Áramlás korlátozó
 E Regulador de flujo de agua

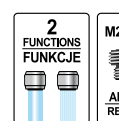
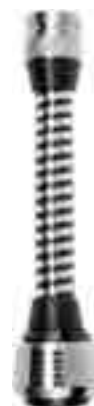

FALA

No.	
75329	10/60

- PL Reduktor przepływu wody
- GB Water flow rate reducer
- D Wassersparer
- RUS Регулятор расхода воды
- CZ Regulátor toku vody
- RO Reductor de debit de apă
- H Áramlás korlátozó
- E Regulador de flujo de agua



FALA

No.	
75330	10/60

- PL Reduktor przepływu wody
- GB Water flow rate reducer
- D Wassersparer
- RUS Регулятор расхода воды
- CZ Regulátor toku vody
- RO Reductor de debit de apă
- H Áramlás korlátozó
- E Regulador de flujo de agua



FALA

No.	
75332	20/120

- PL Korek do umywalki
- GB Pop-up waste
- D Waschbecken Stöpsel
- RUS Автоматическая пробка
- CZ Automatická zátka
- RO Sifon chiuveta
- H Mosdo lefolyó elzaro
- E Tapón automat. para batería de lado



FALA

No.	
75498	12/48

- PL Korek automatyczny
- GB Pop-up waste
- D Waschbecken Stöpsel
- RUS Автоматическая пробка для умывальника
- CZ Automatická zátka
- RO Sifon chiuveta
- H Mosdo lefolyó elzaro
- E Tapón automat. para batería de lado



FALA

No.	
75483	48/96

- PL Reduktor przepływu wody
- GB Water flow rate reducer
- D Wassersparer
- RUS Регулятор расхода воды
- CZ Regulátor toku vody
- RO Reductor de debit de apă
- H Áramlás korlátozó
- E Regulador de flujo de agua



FALA

No.	
75331	10/60

- PL Reduktor przepływu wody
- GB Water flow rate reducer
- D Wassersparer
- RUS Регулятор расхода воды
- CZ Regulátor toku vody
- RO Reductor de debit de apă
- H Áramlás korlátozó
- E Regulador de flujo de agua



FALA

No.	
75333	10/60

- PL Korek do umywalki
- GB Pop-up waste
- D Waschbecken Stöpsel
- RUS Автоматическая пробка
- CZ Automatická zátka
- RO Sifon chiuveta
- H Mosdo lefolyó elzaro
- E Tapón automat. para batería de lado



FALA

No.	
75499	12/48

- PL Korek automatyczny
- GB Pop-up waste
- D Waschbecken Stöpsel
- RUS Автоматическая пробка для умывальника
- CZ Automatická zátka
- RO Sifon chiuveta
- H Mosdo lefolyó elzaro
- E Tapón automat. para batería de lado

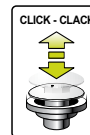

FALA

No.	
75484	20/40

- PL Korek automatyczny
- GB Pop-up waste
- D Waschbecken Stöpsel
- RUS Автоматическая пробка для умывальника
- CZ Automatická zátka
- RO Sifon chiuveta
- H Mosdo lefolyo elzaro
- E Tapón automat. para batería de lado

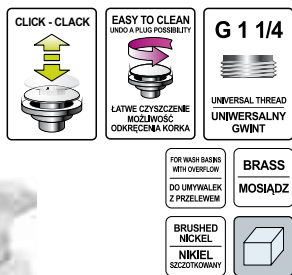

FALA

No.	
75485	20/40

- PL Korek automatyczny
- GB Pop-up waste
- D Waschbecken Stöpsel
- RUS Автоматическая пробка для умывальника
- CZ Automatická zátka
- RO Sifon chiuveta
- H Mosdo lefolyo elzaro
- E Tapón automat. para batería de lado

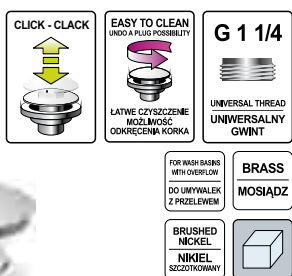

FALA

No.	
75488	20/40

- PL Słuchawka prysznicowa
- GB Shower handle
- D Handbrause
- RUS Разбрызгиватель для душа
- CZ Ruční sprcha
- RO Cap duș
- H Kézi zuhanyfej
- E Ducha



FALA

No.	
75541	20/80

- PL Słuchawka prysznicowa
- GB Shower handle
- D Handbrause
- RUS Разбрызгиватель для душа
- CZ Ruční sprcha
- RO Cap duș
- H Kézi zuhanyfej
- E Ducha



FALA

No.	
75545	15/60

- PL Korek automatyczny
- GB Pop-up waste
- D Waschbecken Stöpsel
- RUS Автоматическая пробка для умывальника
- CZ Automatická zátka
- RO Sifon chiuveta
- H Mosdo lefolyo elzaro
- E Tapón automat. para batería de lado

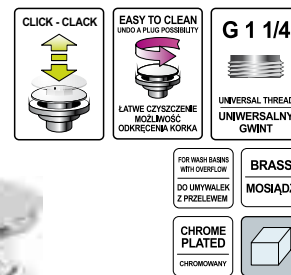

FALA

No.	
75487	20/40

- PL Słuchawka prysznicowa
- GB Shower handle
- D Handbrause
- RUS Разбрызгиватель для душа
- CZ Ruční sprcha
- RO Cap duș
- H Kézi zuhanyfej
- E Ducha



FALA

No.	
75540	20/80

- PL Słuchawka prysznicowa
- GB Shower handle
- D Handbrause
- RUS Разбрызгиватель для душа
- CZ Ruční sprcha
- RO Cap duș
- H Kézi zuhanyfej
- E Ducha

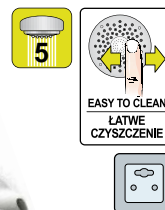

FALA

No.	
75543	12/48

- PL Słuchawka prysznicowa
- GB Shower handle
- D Handbrause
- RUS Разбрызгиватель для душа
- CZ Ruční sprcha
- RO Cap duș
- H Kézi zuhanyfej
- E Ducha



FALA

No.	
75544	15/60

- PL Sluchawka prysznicowa
- GB Shower handle
- D Handbrause
- RUS Разбрызгиватель для душа
- CZ Ruční sprcha
- RO Cap duș
- H Kézi zuhanyfej
- E Ducha



FALA

No.	
75548	30/60

- PL Sluchawka prysznicowa
- GB Shower handle
- D Handbrause
- RUS Разбрызгиватель для душа
- CZ Ruční sprcha
- RO Cap duș
- H Kézi zuhanyfej
- E Ducha



FALA

No.	
75551	30/60

- PL Sluchawka prysznicowa
- GB Shower handle
- D Handbrause
- RUS Разбрызгиватель для душа
- CZ Ruční sprcha
- RO Cap duș
- H Kézi zuhanyfej
- E Ducha



FALA

No.	series / seria	
75627	DELTA	24/48

- PL Sluchawka prysznicowa
- GB Shower handle
- D Handbrause
- RUS Разбрызгиватель для душа
- CZ Ruční sprcha
- RO Cap duș
- H Kézi zuhanyfej
- E Ducha

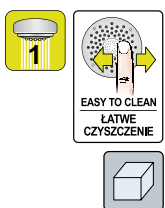

FALA

No.	series / seria	
75631	HERMANA	25/50

- PL Sluchawka prysznicowa
- GB Shower handle
- D Handbrause
- RUS Разбрызгиватель для душа
- CZ Ruční sprcha
- RO Cap duș
- H Kézi zuhanyfej
- E Ducha



FALA

No.	
75550	30/60

- PL Sluchawka prysznicowa
- GB Shower handle
- D Handbrause
- RUS Разбрызгиватель для душа
- CZ Ruční sprcha
- RO Cap duș
- H Kézi zuhanyfej
- E Ducha

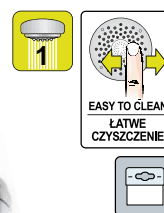

FALA

No.	
75552	30/60

- PL Sluchawka prysznicowa
- GB Shower handle
- D Handbrause
- RUS Разбрызгиватель для душа
- CZ Ruční sprcha
- RO Cap duș
- H Kézi zuhanyfej
- E Ducha



FALA

No.	series / seria	
75629	TUGELA	24/48

- PL Sluchawka prysznicowa
- GB Shower handle
- D Handbrause
- RUS Разбрызгиватель для душа
- CZ Ruční sprcha
- RO Cap duș
- H Kézi zuhanyfej
- E Ducha

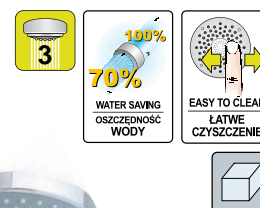

FALA

No.	series / seria	
75626	KILE	25/50

- PL Sluchawka prysznicowa
- GB Shower handle
- D Handbrause
- RUS Разбрызгиватель для душа
- CZ Ruční sprcha
- RO Cap duș
- H Kézi zuhanyfej
- E Ducha

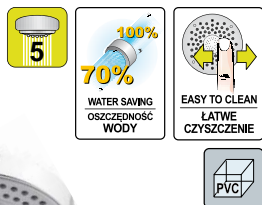

FALA

No.	series / seria	
75625	DETIFOS	25/50

- PL Sluchawka prysznicowa
- GB Shower handle
- D Handbrause
- RUS Разбрызгиватель для душа
- CZ Ruční sprcha
- RO Cap duș
- H Kézi zuhanyfej
- E Ducha

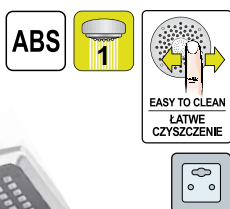

FALA

No.	series / seria	
75632	FOBOS	12

- PL Sluchawka prysznicowa
- GB Shower handle
- D Handbrause
- RUS Разбрызгиватель для душа
- CZ Ruční sprcha
- RO Cap duș
- H Kézi zuhanyfej
- E Ducha

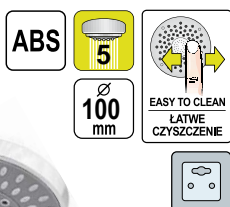

FALA

No.	series / seria	
75634	DIONE	12

- PL Sluchawka prysznicowa
- GB Shower handle
- D Handbrause
- RUS Разбрызгиватель для душа
- CZ Ruční sprcha
- RO Cap duș
- H Kézi zuhanyfej
- E Ducha

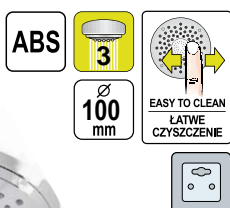

FALA

No.	series / seria	
75636	SILVER MOON	12

- PL Sluchawka prysznicowa
- GB Shower handle
- D Handbrause
- RUS Разбрызгиватель для душа
- CZ Ruční sprcha
- RO Cap duș
- H Kézi zuhanyfej
- E Ducha

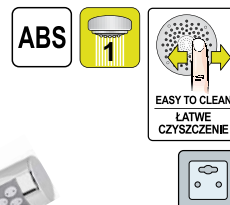

FALA

No.	series / seria	
75628	DEIMOS	12

- PL Sluchawka prysznicowa
- GB Shower handle
- D Handbrause
- RUS Разбрызгиватель для душа
- CZ Ruční sprcha
- RO Cap duș
- H Kézi zuhanyfej
- E Ducha



FALA

No.	series / seria	
75633	JAPET	12

- PL Sluchawka prysznicowa
- GB Shower handle
- D Handbrause
- RUS Разбрызгиватель для душа
- CZ Ruční sprcha
- RO Cap duș
- H Kézi zuhanyfej
- E Ducha



FALA

No.	series / seria	
75635	MIMAS	12

- PL Sluchawka prysznicowa
- GB Shower handle
- D Handbrause
- RUS Разбрызгиватель для душа
- CZ Ruční sprcha
- RO Cap duș
- H Kézi zuhanyfej
- E Ducha



FALA

No.	series / seria	
75637	WHITE MOON	12

PL Słuchawka prysznicowa
GB Shower handle
D Handbrause
RUS Разбрызгиватель для душа
CZ Ruční sprcha
RO Cap duș
H Kézi zuhanyfej
E Ducha



FALA

No.	series / seria	☐
75638	SILVER MOON	12

PL Słuchawka prysznicowa
GB Shower handle
D Handbrause
RUS Разбрызгиватель для душа
CZ Ruční sprcha
RO Cap duș
H Kézi zuhanyfej
E Ducha

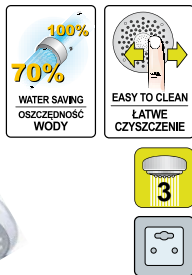

FALA

No.	series / seria	☐
75624	SALTO	25/50

PL Słuchawka prysznicowa
GB Shower handle
D Handbrause
RUS Разбрызгиватель для душа
CZ Ruční sprcha
RO Cap duș
H Kézi zuhanyfej
E Ducha



FALA

No.	series / seria	☐
75620	SALTO	25/50

PL Słuchawka prysznicowa
GB Shower handle
D Handbrause
RUS Разбрызгиватель для душа
CZ Ruční sprcha
RO Cap duș
H Kézi zuhanyfej
E Ducha



FALA

No.	series / seria	☐
75622	SALTO	25/50

PL Słuchawka prysznicowa
GB Shower handle
D Handbrause
RUS Разбрызгиватель для душа
CZ Ruční sprcha
RO Cap duș
H Kézi zuhanyfej
E Ducha

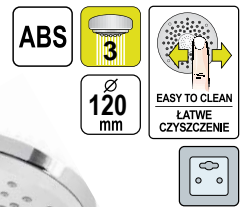

FALA

No.	series / seria	☐
75639	WHITE MOON	12

PL Słuchawka prysznicowa
GB Shower handle
D Handbrause
RUS Разбрызгиватель для душа
CZ Ruční sprcha
RO Cap duș
H Kézi zuhanyfej
E Ducha



FALA

No.	series / seria	☐
75619	SALTO	25/50

PL Słuchawka prysznicowa
GB Shower handle
D Handbrause
RUS Разбрызгиватель для душа
CZ Ruční sprcha
RO Cap duș
H Kézi zuhanyfej
E Ducha



FALA

No.	series / seria	☐
75621	SALTO	25/50

PL Słuchawka prysznicowa
GB Shower handle
D Handbrause
RUS Разбрызгиватель для душа
CZ Ruční sprcha
RO Cap duș
H Kézi zuhanyfej
E Ducha



FALA

No.	series / seria	☐
75623	SALTO	25/50

- PL Uchwyt do słuchawki prysznicowej
- GB Shower holder
- D Brauseporter
- RUS Держатель душ
- CZ Držák s kloubem na sprchu
- RO Suport pt. dus
- H Zuhanycső tartó
- E Grifo para ducha

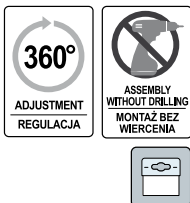

FALA

No.	100
75527	100

- PL Uchwyt do słuchawki prysznicowej
- GB Shower holder
- D Brauseporter
- RUS Держатель душ
- CZ Držák s kloubem na sprchu
- RO Suport pt. dus
- H Zuhanycső tartó
- E Grifo para ducha



FALA

No.	100
75536	100

- PL Uchwyt do słuchawki prysznicowej
- GB Shower holder
- D Brauseporter
- RUS Держатель душ
- CZ Držák s kloubem na sprchu
- RO Suport pt. dus
- H Zuhanycső tartó
- E Grifo para ducha



FALA

No.	100
75539	100

- PL Uchwyt do słuchawki prysznicowej
- GB Shower holder
- D Brauseporter
- RUS Держатель душ
- CZ Držák s kloubem na sprchu
- RO Suport pt. dus
- H Zuhanycső tartó
- E Grifo para ducha



FALA

No.	30/180
75565	30/180

- PL Uchwyt do słuchawki prysznicowej
- GB Shower holder
- D Brauseporter
- RUS Держатель душ
- CZ Držák s kloubem na sprchu
- RO Suport pt. dus
- H Zuhanycső tartó
- E Grifo para ducha



FALA

No.	100
75535	100

- PL Uchwyt do słuchawki prysznicowej
- GB Shower holder
- D Brauseporter
- RUS Держатель душ
- CZ Držák s kloubem na sprchu
- RO Suport pt. dus
- H Zuhanycső tartó
- E Grifo para ducha



FALA

No.	100
75537	100

- PL Uchwyt do słuchawki prysznicowej
- GB Shower holder
- D Brauseporter
- RUS Держатель душ
- CZ Držák s kloubem na sprchu
- RO Suport pt. dus
- H Zuhanycső tartó
- E Grifo para ducha



FALA

No.	50/200
75564	50/200

- PL Wąż prysznicowy
- GB Shower hose
- D Brausenschlauch
- RUS Шланг для душа
- CZ Sprchová hadice
- RO Furtun duș
- H Zuhanycső
- E Manguera de ducha



FALA

No.	L (m)	30/60
75553	1.5	30/60
75554	1.7	30/60

PL Wąż prysznicowy CZ Sprchová hadice
GB Shower hose RO Furtun duș
D Brausenschlauch H Zuhanycső
RUS Шланг для душа E Manguera de ducha



FALA

No.	L (m)	
75574	1.5-2.0	24

PL Wąż prysznicowy CZ Sprchová hadice
GB Shower hose RO Furtun duș
D Brausenschlauch H Zuhanycső
RUS Шланг для душа E Manguera de ducha

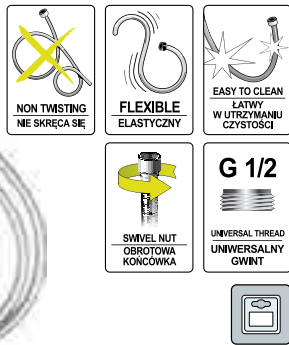

FALA

No.	L (m)	
75596	1.5	24
75597	2.0	24

PL Wąż prysznicowy CZ Sprchová hadice
GB Shower hose RO Furtun duș
D Brausenschlauch H Zuhanycső
RUS Шланг для душа E Manguera de ducha



FALA

No.	L (m)	
75578	1.5	30/60
75579	1.7	30/60

PL Wąż prysznicowy CZ Sprchová hadice
GB Shower hose RO Furtun duș
D Brausenschlauch H Zuhanycső
RUS Шланг для душа E Manguera de ducha

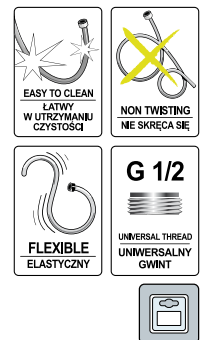

FALA

No.	L (m)	
75595	2.0	24

PL Wąż prysznicowy CZ Sprchová hadice
GB Shower hose RO Furtun duș
D Brausenschlauch H Zuhanycső
RUS Шланг для душа E Manguera de ducha



FALA

No.	L (m)	
75572	1.5	24
75573	2.0	24

PL Wąż prysznicowy CZ Sprchová hadice
GB Shower hose RO Furtun duș
D Brausenschlauch H Zuhanycső
RUS Шланг для душа E Manguera de ducha

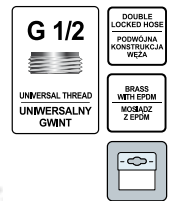

FALA

No.	L (m)	
75570	1.5	30/60

PL Wąż prysznicowy CZ Sprchová hadice
GB Shower hose RO Furtun duș
D Brausenschlauch H Zuhanycső
RUS Шланг для душа E Manguera de ducha



FALA

No.	L (m)	
75598	1.5	24
75599	2.0	24

PL Waż przyłączeniowy elastyczny
 GB Flexible connecting hose
 D Edelstahl Flexschlauch
 RUS Гибкий шланг для смесителя
 CZ Flexibilní nerezové hadice na vodu
 RO Racorduri flexibile pt. apa
 H Rugalmas rozsdamentes acél cső a víz
 E Manguera flexible de acero inoxidable para el agua

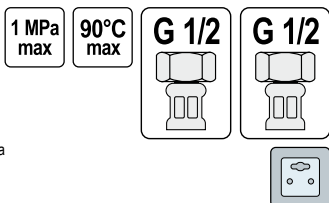

FALA

No.	L (mm)	☐
71800	300	180
71801	400	150
71802	500	120
71803	600	120
71804	800	100
71805	1000	80

PL Waż przyłączeniowy elastyczny
 GB Flexible connecting hose
 D Edelstahl Flexschlauch
 RUS Гибкий шланг для смесителя
 CZ Flexibilní nerezové hadice na vodu
 RO Racorduri flexibile pt. apa
 H Rugalmas rozsdamentes acél cső a víz
 E Manguera flexible de acero inoxidable para el agua

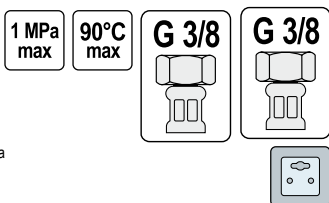

FALA

No.	L (mm)	☐
71814	300	250
71815	400	200
71816	500	150
71817	600	120
71818	800	100
71819	1000	80

PL Waż przyłączeniowy elastyczny
 GB Flexible connecting hose
 D Edelstahl Flexschlauch
 RUS Гибкий шланг для смесителя
 CZ Flexibilní nerezové hadice na vodu
 RO Racorduri flexibile pt. apa
 H Rugalmas rozsdamentes acél cső a víz
 E Manguera flexible de acero inoxidable para el agua

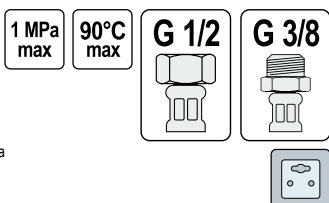

FALA

No.	L (mm)	☐
71827	300	10/300
71828	400	10/250
71829	500	10/200
71830	600	10/150
71831	800	10/100
71832	1000	10/80

PL Waż przyłączeniowy elastyczny
 GB Flexible connecting hose
 D Edelstahl Flexschlauch
 RUS Гибкий шланг для смесителя
 CZ Flexibilní nerezové hadice na vodu
 RO Racorduri flexibile pt. apa
 H Rugalmas rozsdamentes acél cső a víz
 E Manguera flexible de acero inoxidable para el agua

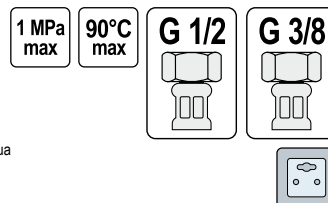

FALA

No.	L (mm)	☐
71807	300	200
71808	400	150
71809	500	120
71810	600	100
71811	800	100
71812	1000	80

PL Waż przyłączeniowy elastyczny
 GB Flexible connecting hose
 D Edelstahl Flexschlauch
 RUS Гибкий шланг для смесителя
 CZ Flexibilní nerezové hadice na vodu
 RO Racorduri flexibile pt. apa
 H Rugalmas rozsdamentes acél cső a víz
 E Manguera flexible de acero inoxidable para el agua

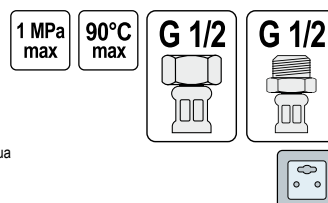

FALA

No.	L (mm)	☐
71820	300	10/250
71821	400	10/200
71822	500	100
71823	600	10/150
71824	800	10/100
71825	1000	10/80

PL Waż przyłączeniowy elastyczny
 GB Flexible connecting hose
 D Edelstahl Flexschlauch
 RUS Гибкий шланг для смесителя
 CZ Flexibilní nerezové hadice na vodu
 RO Racorduri flexibile pt. apa
 H Rugalmas rozsdamentes acél cső a víz
 E Manguera flexible de acero inoxidable para el agua

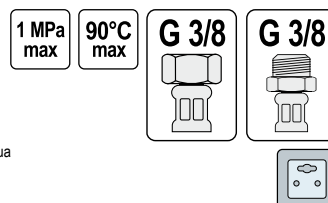

FALA

No.	L (mm)	☐
71833	300	250
71834	400	200
71835	500	200
71836	600	120
71837	800	100
71838	1000	80

- PL Wąż przyłączeniowy elastyczny
GB Flexible connecting hose
D Edelstahl Flexschlauch
RUS Гибкий шланг для смесителя
CZ Flexibilní nerezové hadice na vodu
RO Racorduri flexibile pt. apa
H Rugalmas rozsdamentes acél cső a víz
E Manguera flexible de acero inoxidable para el agua

1 MPa max

90°C max

G 1/2

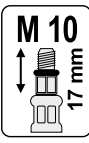
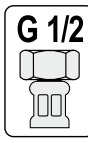
M 10
17 mm

FALA

No.	L (mm)	☐
71840	300	10/300
71841	400	200
71842	500	150
71843	600	120
71844	800	10/100

- PL Wąż przyłączeniowy elastyczny
GB Flexible connecting hose
D Edelstahl Flexschlauch
RUS Гибкий шланг для смесителя
CZ Flexibilní nerezové hadice na vodu
RO Racorduri flexibile pt. apa
H Rugalmas rozsdamentes acél cső a víz
E Manguera flexible de acero inoxidable para el agua

1 MPa max

90°C max

G 3/8

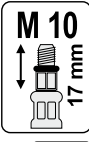
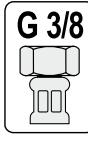
M 10
17 mm

FALA

No.	L (mm)	☐
71851	300	250
71852	400	150
71853	500	150
71854	600	120
71855	800	100

- PL Zestaw łazienkowy
GB Bathroom set
D Brausegarnitur
RUS Набор для душевой
CZ Sprchová souprava
RO Set pt. dus
H Zuhanyzó készlet
E Juego de baño ducha



FALA

No.	☐
75555	12

- PL Wąż przyłączeniowy elastyczny
GB Flexible connecting hose
D Edelstahl Flexschlauch
RUS Гибкий шланг для смесителя
CZ Flexibilní nerezové hadice na vodu
RO Racorduri flexibile pt. apa
H Rugalmas rozsdamentes acél cső a víz
E Manguera flexible de acero inoxidable para el agua

1 MPa max

90°C max

G 1/2

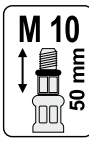
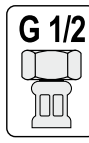
M 10
50 mm

FALA

No.	L (mm)	☐
71846	300	10/300
71847	400	200
71848	500	150
71849	600	120
71850	800	100

- PL Wąż przyłączeniowy elastyczny
GB Flexible connecting hose
D Edelstahl Flexschlauch
RUS Гибкий шланг для смесителя
CZ Flexibilní nerezové hadice na vodu
RO Racorduri flexibile pt. apa
H Rugalmas rozsdamentes acél cső a víz
E Manguera flexible de acero inoxidable para el agua

1 MPa max

90°C max

G 3/8

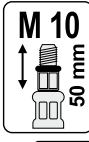
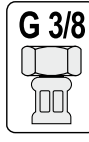
M 10
50 mm

FALA

No.	L (mm)	☐
71856	300	200
71857	400	250
71858	500	150
71859	600	120
71860	800	100

- PL Zestaw łazienkowy
GB Bathroom set
D Brausegarnitur
RUS Набор для душевой
CZ Sprchová souprava
RO Set pt. dus
H Zuhanyzó készlet
E Juego de baño ducha



FALA

No.	☐
75556	12

- PL Zestaw łazienkowy
- GB Bathroom set
- D Brausegarnitur
- RUS Набор для душевой
- CZ Sprchová souprava
- RO Set pt. dus
- H Zuhanyzó készlet
- E Juego de baño ducha



FALA

No.	
75558	12

- PL Zestaw łazienkowy
- GB Bathroom set
- D Brausegarnitur
- RUS Набор для душевой
- CZ Sprchová souprava
- RO Set pt. dus
- H Zuhanyzó készlet
- E Juego de baño ducha



FALA

No.	
75660	5

- PL Kubek kosmetyczny
- GB Tumbler
- D Becher
- RUS Стакан
- CZ Dóza
- RO Suport periuță
- H Fürdőszobai pohár
- E Vaso



FALA

No.	series / seria	
69330	TIER	6/128

- PL Zestaw łazienkowy
- GB Bathroom set
- D Brausegarnitur
- RUS Набор для душевой
- CZ Konzole na sprchu
- RO Suport dus
- H Zuhanyzó rúd
- E Carril de ducha



FALA

No.	
75559	16

- PL Zestaw łazienkowy
- GB Bathroom set
- D Brausegarnitur
- RUS Набор для душевой
- CZ Sprchová souprava
- RO Set pt. dus
- H Zuhanyzó készlet
- E Juego de baño ducha



FALA

No.	
75661	5

- PL Kubek kosmetyczny
- GB Tumbler
- D Becher
- RUS Стакан
- CZ Dóza
- RO Suport periuță
- H Fürdőszobai pohár
- E Vaso



FALA

No.	series / seria	
69337	TUMBLER	6/144

PL Kubek kosmetyczny
GB Tumbler
D Becher
RUS Стакан

CZ Dóza
RO Suport periută
H Fürdőszobai pohár
E Vaso



FALA

No.	series / seria	
69344	CUBOID BEIGE	6/144

PL Kubek kosmetyczny
GB Tumbler
D Becher
RUS Стакан

CZ Dóza
RO Suport periută
H Fürdőszobai pohár
E Vaso



FALA

No.	series / seria	
69357	WAVE	6/60

PL Kubek na szczoteczki do zębów
GB Toothbrush holder
D Zahnputzbecher
RUS Стакан для зубных щеток

CZ Dóza na zubní kartáčky
RO Suport pt. periute dinti
H Fogkefektartó pohár
E Portacepillos



FALA

No.	series / seria	
69338	CUBOID WHITE	6/72

PL Kubek na szczoteczki do zębów
GB Toothbrush holder
D Zahnputzbecher
RUS Стакан для зубных щеток

CZ Dóza na zubní kartáčky
RO Suport pt. periute dinti
H Fogkefektartó pohár
E Portacepillos



FALA

No.	series / seria	
69351	NICKEL	6/96

PL Kubek kosmetyczny
GB Tumbler
D Becher
RUS Стакан

CZ Dóza
RO Suport periută
H Fürdőszobai pohár
E Vaso



FALA

No.	series / seria	
69350	NICKEL	6/96

PL Kubek na szczoteczki do zębów
GB Toothbrush holder
D Zahnputzbecher
RUS Стакан для зубных щеток

CZ Dóza na zubní kartáčky
RO Suport pt. periute dinti
H Fogkefektartó pohár
E Portacepillos



FALA

No.	series / seria	
69331	TIER	6/128

PL Kubek na szczoteczki do zębów
GB Toothbrush holder
D Zahnputzbecher
RUS Стакан для зубных щеток

CZ Dóza na zubní kartáčky
RO Suport pt. periute dinti
H Fogkefektartó pohár
E Portacepillos



FALA

No.	series / seria	
69345	CUBOID BEIGE	6/72

PL Kubek na szczoteczki do zębów
GB Toothbrush holder
D Zahnputzbecher
RUS Стакан для зубных щеток

CZ Dóza na zubní kartáčky
RO Suport pt. periute dinti
H Fogkefektartó pohár
E Portacepillos



FALA

No.	series / seria	
69358	WAVE	6/60

PL Kubek na waciki
GB Cotton box wave
D Wattedose
RUS Емкость косметическая

CZ Dóza kosmetická
RO Suport discete demachiante
H Fürdőszojai pohár
E Vaso



FALA

No.	series / seria	
69359	WAVE	6/48

PL Mydelniczka
GB Soap dish
D Seifenschale
RUS Мыльница

CZ Mydelnička
RO Sapuniera
H Szappantartó tál
E Jabonera



FALA

No.	series / seria	
69339	CUBOID WHITE	6/144

PL Mydelniczka
GB Soap dish
D Seifenschale
RUS Мыльница

CZ Mydelnička
RO Sapuniera
H Szappantartó tál
E Jabonera



FALA

No.	series / seria	
69352	NICKEL	6/192

PL Dozownik mydła w płynie
GB Lotion dispenser
D Seifenspender
RUS Дозатор для жидкого мыла
CZ Dávkovač mýdla
RO Dozator sapun
H Folyékony szappan adagoló
E Dosificador



FALA

No.	series / seria	
69333	TIER	6/96

PL Mydelniczka
GB Soap dish
D Seifenschale
RUS Мыльница

CZ Mydelnička
RO Sapuniera
H Szappantartó tál
E Jabonera



FALA

No.	series / seria	
69332	TIER	6/144

PL Mydelniczka
GB Soap dish
D Seifenschale
RUS Мыльница

CZ Mydelnička
RO Sapuniera
H Szappantartó tál
E Jabonera



FALA

No.	series / seria	
69346	CUBOID BEIGE	6/144

PL Mydelniczka
GB Soap dish
D Seifenschale
RUS Мыльница

CZ Mydelnička
RO Sapuniera
H Szappantartó tál
E Jabonera



FALA

No.	series / seria	
69360	WAVE	6/144

PL Dozownik mydła w płynie
GB Lotion dispenser
D Seifenspender
RUS Дозатор для жидкого мыла
CZ Dávkovač mýdla
RO Dozator sapun
H Folyékony szappan adagoló
E Dosificador



FALA

No.	series / seria	
69340	CUBOID WHITE	6/72

PL Dozownik mydła w płynie
GB Lotion dispenser
D Seifenspender
RUS Дозатор для жидкого мыла
CZ Dávkovač mýdla
RO Dozator sapun
H Folyékony szappan adagoló
E Dosificador



FALA

No.	series / seria	
69347	CUBOID BEIGE	6/72

PL Dozownik mydła w płynie
GB Lotion dispenser
D Seifenspender
RUS Дозатор для жидкого мыла
CZ Dávkovač mýdla
RO Dozator sapun
H Folyékony szappan adagoló
E Dosificador



FALA

No.	series / seria	
69361	WAVE	6/48

PL Szczotka WC
GB Toilet brush holder
D Wc-Bürste
RUS Щетка туалетная
CZ WC kartáč
RO Perie WC
H WC kefe tartó
E Escobillero



FALA

No.	series / seria	
69341	CUBOID WHITE	6/48

PL Szczotka WC
GB Toilet brush holder
D Wc-Bürste
RUS Щетка туалетная
CZ WC kartáč
RO Perie WC
H WC kefe tartó
E Escobillero



FALA

No.	series / seria	
69354	NICKEL	6/24

PL Dozownik mydła w płynie
GB Lotion dispenser
D Seifenspender
RUS Дозатор для жидкого мыла
CZ Dávkovač mýdla
RO Dozator sapun
H Folyékony szappan adagoló
E Dosificador



FALA

No.	series / seria	
69353	NICKEL	6/72

PL Szczotka WC
GB Toilet brush holder
D Wc-Bürste
RUS Щетка туалетная
CZ WC kartáč
RO Perie WC
H WC kefe tartó
E Escobillero



FALA

No.	series / seria	
69334	TIER	6/24

PL Szczotka WC
GB Toilet brush holder
D Wc-Bürste
RUS Щетка туалетная
CZ WC kartáč
RO Perie WC
H WC kefe tartó
E Escobillero



FALA

No.	series / seria	
69348	CUBOID BEIGE	6/48

PL Szczotka WC
GB Toilet brush holder short
D Wc-Bürste
RUS Щетка туалетная
CZ WC kartáč
RO Perie WC
H WC kefe tartó
E Escobillero



FALA

No.	series / seria	
69362	WAVE S	6/36

- PL Szczotka WC wysoka
- GB Toilet brush holder long
- D Wc-Bürste
- RUS Щетка туалетная
- CZ WC kartáč
- RO Perie WC
- H WC kefe tartó
- E Escobillero



FALA

No.	series / seria	
69363	WAVE L	6/12

- PL Organizer na kosmetyki
- GB Cosmetic organizer
- D Kosmetik Organizer
- RUS Органайзер для косметики
- CZ Kosmetický organizér
- RO Organizator cosmetice
- H Kosmetikai vagy ékszer szervező
- E Organizador cosmética



FALA

No.	series / seria	
69401	CRYSTAL 2	72

- PL Organizer na kosmetyki
- GB Cosmetic organizer
- D Kosmetik Organizer
- RUS Органайзер для косметики
- CZ Kosmetický organizér
- RO Organizator cosmetice
- H Kosmetikai vagy ékszer szervező
- E Organizador cosmética



FALA

No.	series / seria	
69403	CRYSTAL 4	24

- PL Organizer na kosmetyki
- GB Cosmetic organizer
- D Kosmetik Organizer
- RUS Органайзер для косметики
- CZ Kosmetický organizér
- RO Organizator cosmetice
- H Kosmetikai vagy ékszer szervező
- E Organizador cosmética



FALA

No.	series / seria	
69405	CRYSTAL 6	12

- PL Organizer na kosmetyki
- GB Cosmetic organizer
- D Kosmetik Organizer
- RUS Органайзер для косметики
- CZ Kosmetický organizér
- RO Organizator cosmetice
- H Kosmetikai vagy ékszer szervező
- E Organizador cosmética



FALA

No.	series / seria	
69400	CRYSTAL 1	72

- PL Organizer na kosmetyki
- GB Cosmetic organizer
- D Kosmetik Organizer
- RUS Органайзер для косметики
- CZ Kosmetický organizér
- RO Organizator cosmetice
- H Kosmetikai vagy ékszer szervező
- E Organizador cosmética

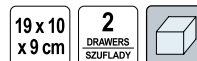

FALA

No.	series / seria	
69402	CRYSTAL 3	24

- PL Organizer na kosmetyki
- GB Cosmetic organizer
- D Kosmetik Organizer
- RUS Органайзер для косметики
- CZ Kosmetický organizér
- RO Organizator cosmetice
- H Kosmetikai vagy ékszer szervező
- E Organizador cosmética

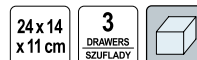

FALA

No.	series / seria	
69404	CRYSTAL 5	12

- PL Organizer na kosmetyki
- GB Cosmetic organizer
- D Kosmetik Organizer
- RUS Органайзер для косметики
- CZ Kosmetický organizér
- RO Organizator cosmetice
- H Kosmetikai vagy ékszer szervező
- E Organizador cosmética

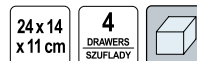

FALA

No.	series / seria	
69406	CRYSTAL 7	12

- PL Organizator na kosmetyki
- GB Cosmetic organizer
- D Kosmetik Organizer
- RUS Органайзер для косметики
- CZ Kosmetický organizér
- RO Organizator cosmetice
- H Kosmetikai vagy ékszer szervező
- E Organizador cosmética



FALA

No.	series / seria	
69407	CRYSTAL 8	12

- PL Mata antypoślizgowa
- GB Anti-slip mat
- D Anti-rutsch-Matte
- RUS Противоскользящий коврик
- CZ Protiskluzová podložka
- RO Mat anti-alunecare
- H Csúszásgátló lábtörő
- E Alfombra antideslizante

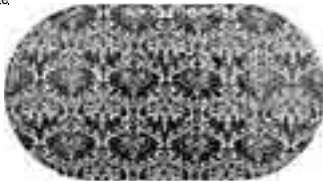
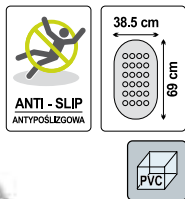

FALA

No.	size / rozmiar (cm)	
75911	69x38.5	24

- PL Mata antypoślizgowa
- GB Anti-slip mat
- D Anti-rutsch-Matte
- RUS Противоскользящий коврик
- CZ Protiskluzová podložka
- RO Mat anti-alunecare
- H Csúszásgátló lábtörő
- E Alfombra antideslizante

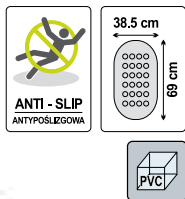

FALA

No.	size / rozmiar (cm)	
75914	69x38.5	24

- PL Zaslanka prysznicowa
- GB Shower curtain
- D Duschvorhang
- RUS Занавеска для душа
- CZ Sprchový závěs
- RO Perdea duș
- H Zuhanyfüggöny
- E Cortina de ducha

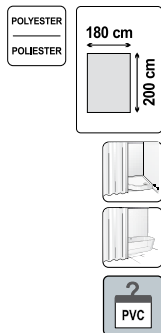

FALA

No.	size / rozmiar (cm)	
75971	180x200	24

- PL Organizator na kosmetyki
- GB Cosmetic organizer
- D Kosmetik Organizer
- RUS Органайзер для косметики
- CZ Kosmetický organizér
- RO Organizator cosmetice
- H Kosmetikai vagy ékszer szervező
- E Organizador cosmética



FALA

No.	series / seria	
69408	CRYSTAL 9	12

- PL Mata antypoślizgowa
- GB Anti-slip mat
- D Anti-rutsch-Matte
- RUS Противоскользящий коврик
- CZ Protiskluzová podložka
- RO Mat anti-alunecare
- H Csúszásgátló lábtörő
- E Alfombra antideslizante

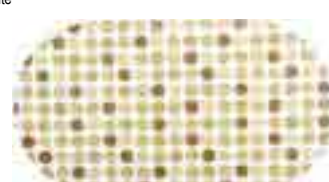
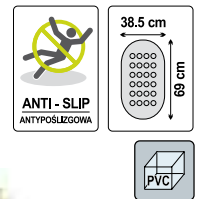

FALA

No.	size / rozmiar (cm)	
75912	69x38.5	24

- PL Zaslanka prysznicowa
- GB Shower curtain
- D Duschvorhang
- RUS Занавеска для душа
- CZ Sprchový závěs
- RO Perdea duș
- H Zuhanyfüggöny
- E Cortina de ducha

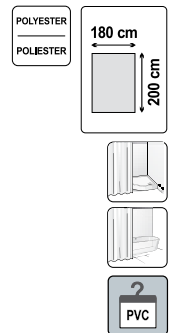

FALA

No.	size / rozmiar (cm)	
75970	180x200	24

- PL Zaslanka prysznicowa
- GB Shower curtain
- D Duschvorhang
- RUS Занавеска для душа
- CZ Sprchový závěs
- RO Perdea duș
- H Zuhanyfüggöny
- E Cortina de ducha

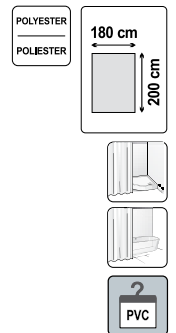

FALA

No.	size / rozmiar (cm)	
75972	180x200	24

- PL Zaslonka prysznicowa
- GB Shower curtain
- D Duschvorhang
- RUS Занавеска для душа
- CZ Sprchový záves
- RO Perdea duș
- H Zuhanyfüggöny
- E Cortina de ducha



POLYESTER
POLIESTER

180 cm
200 cm

FALA

No.	size / rozmiar (cm)	
75973	180x200	24

- PL Deska sedesowa
- GB Toilet seat
- D WC Deckel
- RUS Сиденье для унитаза
- CZ WC sedátko
- RO Capac WC
- H WC-ülöke
- E Asiento de inodoro

UNIVERSAL SIZE
UNIVERSALNY ROZMIAR

STAINLESS STEEL HINGES
MOCOWANIE ZE STALI NIERDZEWNEJ

SLOW CLOSE
WOLNE OPADANIE

ONE BUTTON QUICK RELEASE
WYPNANA 1 PRZYCISKIEM

EASY TO CLEAN
LATWE CZYSZCZENIE

ANTIBACTERIAL
ANTI-BACTERIALNA

360°
ECCENTRIC ASSEMBLY
MIKROSDROWY MONTAZ

TOP LOCK HINGES
GÓRNY MONTAZ ZAWIASOW

FALA

No.		
75466		5

- PL Deska sedesowa
- GB Toilet seat
- D WC Deckel
- RUS Сиденье для унитаза
- CZ WC sedátko
- RO Capac WC
- H WC-ülöke
- E Asiento de inodoro

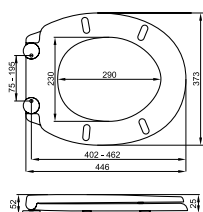

FALA

No.		
75468		5

- PL Deska sedesowa
- GB Toilet seat
- D WC Deckel
- RUS Сиденье для унитаза
- CZ WC sedátko
- RO Capac WC
- H WC-ülöke
- E Asiento de inodoro

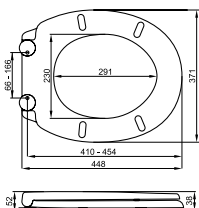

UNIVERSAL SIZE
UNIVERSALNY ROZMIAR

STAINLESS STEEL HINGES
MOCOWANIE ZE STALI NIERDZEWNEJ

SLOW CLOSE
WOLNE OPADANIE

ONE BUTTON QUICK RELEASE
WYPNANA 1 PRZYCISKIEM

EASY TO CLEAN
LATWE CZYSZCZENIE

ANTIBACTERIAL
ANTI-BACTERIALNA

360°
ECCENTRIC ASSEMBLY
MIKROSDROWY MONTAZ

TOP LOCK HINGES
GÓRNY MONTAZ ZAWIASOW

FALA

No.		
75465		5

- PL Deska sedesowa
- GB Toilet seat
- D WC Deckel
- RUS Сиденье для унитаза
- CZ WC sedátko
- RO Capac WC
- H WC-ülöke
- E Asiento de inodoro

UNIVERSAL SIZE
UNIVERSALNY ROZMIAR

STAINLESS STEEL HINGES
MOCOWANIE ZE STALI NIERDZEWNEJ

SLOW CLOSE
WOLNE OPADANIE

ONE BUTTON QUICK RELEASE
WYPNANA 1 PRZYCISKIEM

EASY TO CLEAN
LATWE CZYSZCZENIE

ANTIBACTERIAL
ANTI-BACTERIALNA

360°
ECCENTRIC ASSEMBLY
MIKROSDROWY MONTAZ

TOP LOCK HINGES
GÓRNY MONTAZ ZAWIASOW

FALA

No.		
75467		5

UNIVERSAL SIZE
UNIVERSALNY ROZMIAR

STAINLESS STEEL HINGES
MOCOWANIE ZE STALI NIERDZEWNEJ

SLOW CLOSE
WOLNE OPADANIE

ONE BUTTON QUICK RELEASE
WYPNANA 1 PRZYCISKIEM

EASY TO CLEAN
LATWE CZYSZCZENIE

ANTIBACTERIAL
ANTI-BACTERIALNA

360°
ECCENTRIC ASSEMBLY
MIKROSDROWY MONTAZ

TOP LOCK HINGES
GÓRNY MONTAZ ZAWIASOW

- PL Deska sedesowa
- GB Toilet seat
- D WC Deckel
- RUS Сиденье для унитаза
- CZ WC sedátko
- RO Scaun WC
- H WC-ülőke
- E Asiento de inodoro

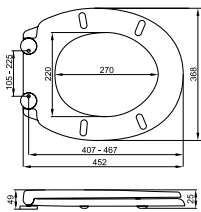
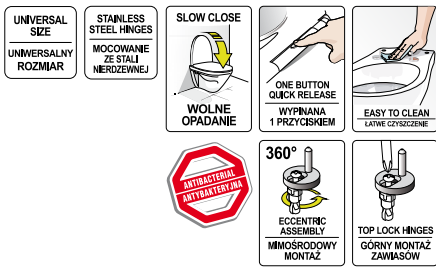

FALA

No.	
75469	5

- PL Lampka LED do podświetlania WC
- GB LED toilet light
- D WC LED Lampe
- RUS LED ночник для туалета
- CZ WC LED světlo
- RO Lumină pt. toaletă
- H LED WC megvilágítás
- E WC LED lámpara



RGB LED



FALA



No.	
75455	100

- PL Stolek plastikowy
- GB Plastic stool
- D Kunststoff Hocker
- RUS Пластиковый табурет
- CZ Plastová stolička
- RO Scaun de plastic
- H Műanyag székel
- E Taburete de plástico



FALA

No.	size / rozmiar (cm)	
75916	30x20x21	10/20

- PL Deska sedesowa
- GB Toilet seat
- D WC Deckel
- RUS Сиденье для унитаза
- CZ WC sedátko
- RO Scaun WC
- H WC-ülőke
- E Asiento de inodoro



FALA

No.	
75470	6

- PL Stolek plastikowy
- GB Plastic stool
- D Kunststoff Hocker
- RUS Пластиковый табурет
- CZ Plastová stolička
- RO Scaun de plastic
- H Műanyag székel
- E Taburete de plástico



FALA

No.	size / rozmiar (cm)	
75915	30x20x21	10/20

- PL Pompa łazienkowa do pryszniców i umywalk
- GB Waste pump for shower and basin
- D Haushaltspumpe für Dusche und Waschtisch
- RUS Санитарный насос
- CZ Koupeľňové čerpadlo pro sprchy
- RO Pompa pt. ape uzate - dus, lovoar
- H Szivattyú zuhanyzóhoz
- E Bomba de evacuación



FALA

No.	W	
75945	250	1

Convenient and easy to use

Wygodna i łatwa obsługa.



Rotation 360°

Mixing water flow with intake air reduces consumption by half, without splashing.

Zmieszany strumień wody z zasysanym powietrzem oszczędza zużycie o połowę i nie chlapie.



ECOflow

Additional protection against contamination.

Dodatkowa ochrona przed zanieczyszczeniami.



built-in-filter

- PL Przepływowy podgrzewacz wody z baterią
- GB Instant heating faucet
- D Elektrische Warmwasser-Armatur
- RUS Миттевий водонагривач
- CZ Ohřivač vody
- RO Robinet electric
- H Átfolyós vízmelegítő csaptelep
- E Calefacción instantáneo grifo

220-240 V-50-60 Hz	3-3.6 kW	G 1/2
0.04-0.6 MPa	1.2 m	20 cm





FALA

No.	series / seria	
75930	STROKKUR 1	10

- PL Przepływowy podgrzewacz wody z baterią
- GB Instant heating faucet
- D Elektrische Warmwasser-Armatur
- RUS Миттевий водонагривач
- CZ Ohřivač vody
- RO Robinet electric
- H Átfolyós vízmelegítő csaptelep
- E Calefacción instantáneo grifo

220-240 V-50-60 Hz	3-3.6 kW	G 1/2
0.04-0.6 MPa	1.2 m	20 cm





FALA

No.	series / seria	
75932	STROKKUR 3	10

- PL Przepływowy podgrzewacz wody z baterią
- GB Instant heating faucet
- D Elektrische Warmwasser-Armatur
- RUS Миттевий водонагривач
- CZ Ohřivač vody
- RO Robinet electric
- H Átfolyós vízmelegítő csaptelep
- E Calefacción instantáneo grifo

220-240 V-50-60 Hz	3-3.6 kW	G 1/2
0.04-0.6 MPa	1.2 m	10 cm



FALA

No.	series / seria	
75931	STROKKUR 2	10

- PL Pistolet do udrażniania rur
- GB Drain cleaner
- D Pistole zum Reinigen von Rohren
- RUS Пистолет для прочистки труб
- CZ Pistole na čištění trubek
- RO Pistol pt. curățarea țevilor
- H Csőtisztító pisztoly
- E Pistola destapacaños

135 mm



VOREL

No.	Ø (mm)	
55500	135	10



- PL Pompa do udrażniania kanalizacji
- GB Drain suction pump
- D Hochdruck-Rohrreiniger
- RUS Ручной насос для прочистки труб
- CZ Čerpadlo na čištění trubek
- RO Pompă pt. curățarea țevilor
- H Csőtisztító szivattyú
- E El desagüe del fregadero limpiador



No.	Ø (mm)	24
55505	65; 155	24

- PL Spirala kanalizacyjna
- GB Drain auger
- D Hand-Rohrreinigungsspirale
- RUS Трос сантехнический пружинный
- CZ Spirála kanalizační
- RO Dispozitiv de desfundat scurgere
- H Csőtisztító spirál
- E Desatascador espiral



No.	Ø (mm)	L (m)	20/80
55541	5	1.5	20/80
55542	6	3	18/36

- PL Przepychacz do udrażniania kanalizacji
- GB Pipe cleaner
- D Räumdom zum Reinigen der Kanalisation
- RUS Поршень для прочистки канализации
- CZ Tlakový čistič kanalizace
- RO Piston pt. deblocarea canalizării
- H Lefolyótisztító pumpa
- E Bomba destaparacaños



No.	L (cm)	pcs	36
55531	65	2	36

- PL Spirala kanalizacyjna
- GB Drain auger
- D Hand-Rohrreinigungsspirale
- RUS Трос сантехнический пружинный
- CZ Spirála kanalizační
- RO Dispozitiv de desfundat scurgere
- H Csőtisztító spirál
- E Desatascador espiral



No.	Ø (mm)	L (m)	5/10
55544	9	5	5/10
55545	9	10	4/8

Memo

No.	Page	No.	Page	No.	Page	No.	Page	No.	Page	No.	Page	No.	Page	No.	Page
00300	136	05050	104	06303	150	06797	151	07883	109	08510	100	08780	86	09080	151
00320	136	05100	103	06304	149	06820	103	07884	109	08511	100	08781	86	09090	151
00510	136	05300	160	06305	150	06840	104	07885	109	08520	100	08782	86	09094	152
00600	136	05301	160	06306	150	06860	104	07886	109	08521	100	08783	86	09100	125
00610	136	05302	160	06307	149	06930	97	07910	109	08522	100	08785	86	09130	125
00703	136	05311	160	06308	149	06940	97	07911	109	08533	110	08786	86	09150	125
01060	136	05312	161	06309	149	06950	97	07912	109	08534	110	08787	86	09160	125
02300	136	05540	83	06310	150	06960	97	07913	109	08536	110	08788	86	09170	125
02400	137	05560	83	06320	150	06963	97	07914	109	08538	110	08790	86	09171	125
03150	137	05580	83	06330	150	06964	97	07915	109	08540	110	08791	86	09172	125
03160	137	05600	83	06331	150	06965	97	07916	109	08542	110	08792	86	09173	125
03220	137	05801	147	06335	151	06970	97	07920	110	08545	110	08793	86	09180	161
03221	137	05802	147	06340	147	06971	97	07950	110	08553	110	08811	87	09190	161
03240	82	05803	147	06341	147	06972	97	07960	111	08554	110	08819	87	09302	154
03241	82	05804	147	06350	147	06973	97	07962	111	08556	110	08820	87	09303	154
03245	82	05805	147	06351	147	06974	97	07970	110	08558	110	08821	87	09307	153
03246	82	05806	147	06360	147	06975	97	07974	89	08560	110	08822	87	09308	153
03300	83	05807	147	06370	147	06976	97	07975	89	08562	110	08825	87	09310	154
03301	83	05821	148	06380	147	06977	98	07976	89	08565	110	08827	87	09311	154
03900	139	05822	148	06388	159; 385	06978	98	07977	89	08573	110	08828	87	09331	154
03920	139	05823	148	06390	159; 385	06979	98	07978	89	08574	110	08829	87	09332	154
03940	139	05830	148	06391	159	06980	98	07984	89	08576	110	08831	87	09334	153
03950	139	05831	148	06392	159; 385	06981	98	07985	89	08578	110	08832	87	09336	153
03990	82	05840	148	06393	159; 385	06982	98	07986	89	08580	110	08833	87	09338	154
04000	137	05850	148	06394	160	06983	98	07987	89	08582	110	08834	87	09345	153
04001	137	05901	150	06395	160	06985	98	07988	89	08585	110	08835	87	09346	153
04020	137	05902	150	06396	160	06986	98	08170	87	08630	87	08836	87	09359	153
04022	137	05903	150	06397	160	06987	98	08171	87	08631	87	08837	87	09363	154
04050	139	05904	150	06398	160	06988	98	08174	87	08633	87	08838	87	09365	154
04100	139	05905	150	06399	160	06989	98	08175	87	08635	87	08845	87	09370	153
04131	138	05906	150	06400	145	06990	98	08177	87	08636	87	08851	87	09371	153
04200	137	05911	150	06401	145	06992	98	08186	88	08638	87	08853	87	09372	153
04210	138	05912	150	06410	145	06993	99	08188	88	08639	87	08854	87	09373	153
04300	48; 123	05913	150	06420	145	06994	99	08190	88	08640	87	08855	87	09375	154
04301	48; 123	05914	150	06430	145	06995	99	08191	88	08641	87	08860	89	09377	154
04400	138	05915	150	06440	145	07060	108	08193	88	08642	87	08861	89	09378	154
04405	138	05916	150	06450	153	07080	108	08200	88	08644	87	08864	89	09385	155
04406	138	05921	150	06452	153	07100	108	08201	88	08646	87	08865	89	09390	155
04410	138	05922	150	06453	153	07120	109	08203	88	08656	87	08868	89	09395	155
04500	139	05923	150	06470	145	07180	109	08288	109	08658	87	08869	89	09400	159
04510	139	05924	150	06472	145	07240	109	08289	109	08663	88	08873	89	09406	154
04540	140	05925	150	06500	145	07320	109	08290	109	08665	88	08875	89	09408	154
04542	140	05926	150	06510	145	07400	109	08291	109	08669	88	08876	89	09412	154
04544	140	06030	149	06512	146	07506	109	08292	109	08671	88	09005	151	09413	154
04546	140	06040	149	06520	145	07508	109	08293	109	08672	88	09006	151	09421	155
04561	290	06050	149	06530	146	07510	109	08300	99	08674	88	09010	151	09422	155
04562	290	06060	149	06532	147	07512	109	08301	110	08681	88	09015	151	09425	155
04600	141	06080	149	06537	147	07530	109	08302	110	08683	88	09017	151	09427	155
04610	141	06100	149	06538	147	07540	109	08303	110	08710	85	09025	152	09429	155
04620	141	06110	147	06540	146	07560	109	08304	110	08711	85	09028	152	09430	155
04630	141	06120	147	06640	146	07580	109	08306	110	08712	85	09036	152	09457	157
04640	141	06130	149	06650	146	07610	109	08307	110	08714	85	09038	152	09459	157
04650	141	06140	149	06660	146	07620	109	08308	110	08715	85	09040	152	09462	157
04660	141	06150	149	06670	146	07630	109	08312	99	08731	86	09044	152	09463	157
04668	141	06290	149	06680	146	07650	108	08314	99	08732	86	09046	152	09465	291
04670	141	06294	149	06690	146	07664	109	08315	99	08734	86	09048	152	09466	291
04690	140	06295	149	06700	146	07665	109	08316	99	08735	86	09049	152	09467	291
04691	140	06296	149	06701	146	07666	109	08318	99	08751	86	09050	152	09470	157; 291
04692	140	06297	149	06740	146	07667	109	08350	100	08752	86	09051	152	09471	157; 291
04700	141	06298	149	06760	146	07668	109	08400	100	08754	86	09054	152	09472	157; 291
04710	141	06299	150	06780	146	07879	109	08410	100	08755	86	09056	152	09473	292
04720	141	06300	150	06781	146	07880	109	08450	100	08770	89	09060	151	09474	292
04721	141	06301	149	06795	150	07881	109	08500	100	08771	89	09063	152	09475	157; 291
04750	148	06302	150	06796	151	07882	109	08501	100	08773	89	09065	152	09476	157; 291

No.	Page	No.	Page	No.	Page	No.	Page	No.	Page	No.	Page	No.	Page	No.	Page
09477	157; 291	10135	166	17490	131; 168	21600	77	23328	78	23692	80	24800	85	26220	108
09478	157; 291	10138	166	17495	131; 168	21650	78	23329	78	23693	80	24810	85	26225	108; 241
09480	291; 385	10139	166	17500	168	21900	78	23331	79	23694	80	24813	85	27000	93
09481	291; 385	11310	166	17501	168	21905	78	23371	80	23710	80	24820	85	27100	93
09482	291; 385	11311	166	17505	168	21910	78	23372	80	23720	80	24823	85	27200	93
09483	291; 386	11313	166	17507	168	21915	78	23373	80	23722	80	24900	84	27322	93
09484	291; 386	12100	166	17508	168	21919	78	23374	80	23723	80	24940	84	27495	93
09486	292	12200	166	17560	173	21921	78	23375	80	23724	80	24950	84	27500	95
09487	292	12300	166	17570	171	21924	78	23376	80	23730	80	24960	84	27501	95
09489	292	12500	166	17606	173	21927	78	23377	80	23740	80	24961	84	27502	95
09490	292	12502	166	17608	173	21929	78	23378	80	23750	80	24962	84	27505	95
09521	155	12503	166	17610	173	21932	78	23379	80	23752	80	24963	84	27506	95
09522	155	13200	166	17612	173	21934	78	23380	80	23800	80	24964	84	27510	95
09523	155	13300	166	17615	173	21936	78	23381	80	23820	80	24965	84	27511	95
09524	155	13500	166	17620	173	21941	78	23382	80	23830	80	24966	84	27513	95
09525	155	14100	166	17701	144; 386	21944	78	23383	80	23832	80	25160	105	27520	95
09531	155	14200	166	17704	144; 386	21948	78	23390	80	23840	80	25161	106	27540	138
09532	155	14300	166	17705	145; 387	21950	78	23391	80	23850	80	25162	106	27575	86
09533	155	14500	166	18200	170	21951	78	23392	80	23860	80	25163	106	27600	93
09534	155	15004	167	18201	170	21952	78	23393	80	23862	80	25164	106	27800	95
09535	155	15005	167	18250	170	21955	78	23394	80	23880	80	25165	106	27810	96
09536	155	15006	167	18300	170	21956	78	23395	80	23882	80	25166	106	27811	96
09537	155	15007	167	18350	170	21958	78	23396	80	23883	80	25170	107	27812	96
09560	156	15010	167	18360	170	21961	78	23397	80	23920	80	25171	107	27813	96
09561	156	15020	167	18361	170	21963	78	23398	80	23930	80	25172	107	27814	96
09562	156	15050	167	18362	170	21966	78	23399	80	23932	80	25173	107	27815	96
09581	156	15070	167	18470	171	21998	78	23400	80	23960	80	25230	107	27820	96
09583	156	15100	167	18473	171	21999	78	23401	80	23962	80	25300	107	27830	96
09585	156	15110	167	18501	171	22130	77	23402	80	23980	80	25301	107	27831	96
09587	156	15130	167	18502	171	22180	77	23403	80	23982	80	25307	108	27832	96
09589	156	15200	167	18503	171	22190	77	23411	80	23988	80	25310	108	27833	96
09636	156	15220	167	18504	171	22250	77	23412	80	23990	80	25351	107	27834	96
09638	156	15240	167	18797	171	22300	77	23413	80	23992	80	25352	107	28000	92; 148
09640	156	16000	173	18798	171	22310	77	23414	80	23999	80	25353	107	28010	92; 148
09642	156	16001	173	18799	171	22330	77	23415	80	24000	85	25360	106	28011	93; 148
09647	156	16002	173	18800	171	22340	77	23416	80	24295	85	25370	106	28012	93; 148
09648	156	16012	173	18810	171	22350	79	23417	80	24300	83	25380	106	28380	91
09649	156	16030	138	19750	171	22380	79	23418	80	24310	83	25390	106	28381	91
09650	156	16280	172	19770	171	22381	79	23419	80	24320	83	25400	242	28382	91
09651	156	16300	172	20100	77	22460	79	23420	80	24330	83	25410	242	28385	92
09653	156	16301	173	20150	77	22465	79	23421	80	24340	83	25411	243	28386	92
09655	156	16340	173	20200	77	22466	79	23422	80	24350	83	25412	243	28387	92
09656	156	16360	173	20250	77	22500	79	23423	80	24370	84	25450	242	28394	92
09920	156	16380	173	20280	77	22550	85	23424	80	24390	84	25500	63	28395	92
09930	156	16400	173	20300	77	22551	85	23585	81	24410	84	25510	63	28640	355
09950	156	16551	173	20320	77	22565	82	23586	82	24430	84	25511	63	28641	355
10010	292	16552	173	20350	77	22570	82	23590	80	24450	84	25512	63	28642	355
10011	292	16553	173	20400	77	22571	83	23591	81	24470	84	25513	63	28650	92
10012	292	16554	173	20420	77	22572	82	23592	81	24500	84	25514	63	28680	83
10013	292	16555	173	20450	77	23311	78	23593	81	24510	84	25515	63	28690	83
10014	293	16556	173	20500	77	23312	78	23601	81	24520	84	25516	63	28710	83
10015	293	16557	173	20550	77	23313	78	23602	81	24530	84	25517	63	28720	83
10101	166	17300	170	20600	77	23314	78	23603	81	24550	84	25518	63	28725	83
10104	166	17310	170	20650	77	23315	78	23604	81	24570	84	25519	63	28733	83
10106	166	17470	131; 168	20700	77	23316	78	23605	81	24590	84	25520	63	28740	92; 355
10109	166	17471	131; 168	20800	77	23317	78	23606	81	24610	84	25521	63	28745	92; 355
10111	166	17473	131; 168	20850	77	23318	78	23608	81	24630	84	25530	63	28746	92; 355
10122	166	17474	131; 168	20900	77	23319	78	23620	80	24650	84	25700	63	28750	92; 355
10123	166	17480	131; 169	21000	77	23320	78	23640	80	24670	84	25830	105	28755	92; 355
10125	166	17481	131; 169	21100	77	23321	78	23650	80	24700	84	25860	105	28771	92; 356
10128	166	17483	131; 169	21200	77	23324	78	23660	80	24710	84	25880	105	28772	92; 356
10129	166	17484	131; 169	21250	77	23325	78	23670	80	24730	85	26150	108	28773	92; 356
10130	166	17488	131; 168	21300	77	23326	78	23680	80	24740	85	26200	108	28790	93
10133	166	17489	131; 168	21400	77	23327	78	23690	80	24750	85	26210	108	28880	136

29000	94	31500	60	33550	62	35368	64	35805	363	36015	71	40015	46	44100	51
29050	94	31600	60	33555	62	35372	64	35806	363	36016	71	40016	46	44102	51
29090	95	31800	60	33557	62	35373	64	35807	363	36018	71	40017	46	44300	51; 252
29100	95	32000	60	33650	62	35374	64	35808	364	36032	72	40018	46	44301	51; 252
29210	94	32110	61; 252	33655	62	35376	64	35809	361	36033	72	40041	46	44400	51; 252
29220	94	32201	61	33657	62	35430	64	35810	361	36034	72	40042	46	44500	51; 252
29311	94	32202	61	33900	62	35600	160; 385	35811	361	36037	72	40043	46	45000	56
29312	94	32203	61	33905	62	35610	385	35813	365	36038	72	40044	46	45010	56
29313	94	32204	61	33907	62	35611	385	35815	364	36039	72	40045	46	45012	57
29317	94	32205	61	33925	62	35620	387	35816	364	36570	72; 114	40047	46	45020	57
29318	94	32206	61	33927	62	35621	387	35817	362	36650	72	40048	46	45050	56
29319	94	32207	61	33950	63; 252	35622	387	35821	370	37100	70	40050	46	45100	56
29323	94	32208	61	34204	65	35670	362	35823	370	37101	70	40051	46	45151	56
29992	61	32625	61	34205	65	35671	362	35824	370	37102	70	40054	47	45201	56
29993	61	32627	62	34206	65	35680	363	35826	370	37103	70	40055	47	45500	56
29994	61	32685	61	34207	65	35700	366	35828	370	37104	70	40056	47	45503	56
29995	61	32687	62	34208	65	35701	362	35830	370	37106	70	40057	47	48000	89; 253
29996	61	32705	62	34210	65	35705	362	35831	370	37107	70	40160	48	48050	90; 253
29997	61	32715	62	34212	65	35710	368	35832	369	37108	70	40180	48	48060	90; 253
30010	60	32720	61	34220	65	35750	367	35833	361	37109	70	40200	48	48070	90; 253
30020	60	32900	67	34222	65	35751	367	35839	364	37110	70	40700	48	48080	90; 253
30030	60	32901	67	34225	65	35755	367	35840	364	37111	70	41121	47	48081	90; 254
30040	60	32902	67	34243	64	35756	362	35842	364	37112	70	41151	47	48082	90; 253
30050	60	32922	67; 358	34245	64	35757	362	35843	361	37113	70	41152	47	48100	90; 253
30060	60	32923	67; 358	34247	64	35758	362	35846	364	37114	70	41180	47	48150	91; 254
30080	60	32924	66; 357	34251	64	35759	362	35850	364	37115	70	41200	47	48200	90; 253
30100	60	32925	66; 357	34254	64	35760	368	35855	361	37150	70	41381	48	48330	91; 254
30150	60	32926	66; 357	34256	64	35761	362	35860	364	37200	70	41500	47	49200	91
30200	60	32927	66; 357	34300	65	35762	362	35861	361	37250	70	41510	52; 114	49450	91
30310	60	32928	66; 357	34600	65	35763	365	35863	361	37300	70	42300	48	49460	91
30320	60	32930	65; 356	34750	65	35764	366	35864	365	37380	70	42301	48	49600	91
30330	60	33000	66; 357	34900	65	35765	359	35865	365	37400	70	42302	49	49750	91
30340	60	33001	66; 357	34944	151	35767	359	35867	289	37430	70	42303	48	49760	91
30350	60	33002	66; 357	34945	151	35768	359	35868	289	37500	70	42304	49	49770	91
30360	60	33003	66; 357	34946	151	35770	366	35869	289	37800	70	42305	49	49771	91
30380	60	33004	66; 357	34947	151	35773	366	35870	289	37900	70	42306	49	49772	91
30390	60	33005	66; 357	34949	387	35774	366	35872	289	38150	70	42307	49	49773	91
30395	60	33006	66; 357	34950	161	35775	368	35874	289	38200	70	42308	49	49774	91
30400	60	33007	66; 357	35010	161	35776	366	35875	289	38401	70	42309	49	49775	91
30410	60	33008	66; 357	35012	162	35777	366	35876	289	38402	70	43010	49	49800	161
30420	60	33022	67; 357	35013	162	35779	365	35877	289	38403	70	43011	49	49801	161
30430	60	33024	66; 356	35015	162	35780	365	35878	290; 368	38404	70	43020	50	49802	161
30440	60	33026	66; 356	35017	162	35781	365	35880	290; 368	38406	70	43021	50	49805	161
30450	60	33028	66; 356	35020	162	35782	365	35893	289; 369	38407	70	43030	50	49806	161
30460	60	33030	66; 356	35021	162	35783	365	35894	289; 369	38408	70	43031	50	49830	161
30480	60	33032	66; 356	35025	162	35784	365	35895	289; 369	38409	70	43040	50	50070	10
30500	60	33035	66; 356	35026	162	35785	365	35899	290; 369	38430	71	43041	50	50090	10
30510	60	33038	66; 356	35030	163	35786	367	35905	290; 369	38431	71	43050	50	50100	10
30520	60	33039	66; 356	35031	163	35787	367	35906	290; 369	38432	71	43051	50	50110	10
30531	60	33040	66; 356	35032	163	35788	366	35908	290; 369	38433	71	43052	50	50120	10
30532	60	33065	66; 356	35033	163	35789	366	35911	289; 369	38434	71	43053	50	50130	10
30533	60	33067	65; 356	35210	104	35790	367	35912	289; 369	38435	71	43055	50	50150	10
30534	60	33080	65; 356	35240	104	35791	367	35914	289	38436	71	43056	50	50170	10
30535	60	33085	66; 356	35250	64	35792	366	35915	289	38500	70	43057	50	50190	10
30536	60	33087	65; 356	35300	64	35793	368	35916	289	38515	70	43058	50	50220	10
31010	60	33105	66; 356	35351	64	35794	368	35918	289	38525	70	43060	50	50270	10
31030	60	33107	65; 356	35352	64	35795	368	35923	289	38750	70	43061	50	50330	10
31050	60	33125	66; 356	35353	64	35797	362	35924	289	38751	71	43062	50	50560	10
31070	60	33127	65; 356	35355	64	35798	365	36000	71	38830	71	43063	50	50580	10
31100	60	33147	65; 356	35359	64	35799	362	36004	71	40010	46	43140	50	50590	10
31150	60	33177	65; 356	35360	64	35800	363	36005	71	40011	46	43500	51	50610	10
31200	60	33530	63	35362	64	35801	363	36006	71	40012	46	43510	51	50620	10
31300	60	33532	63; 252	35364	64	35802	363	36008	71	40013	46	43600	105	50630	10
31400	60	33535	62	35366	64	35803	363	36014	71	40014	46	43603	105	50850	8

No.	Page	No.	Page	No.	Page	No.	Page	No.	Page	No.	Page	No.	Page	No.	Page
50861	8	51740	10	53320	16	54710	12	56550	41	58690	22	60976	29	64371	36
50871	8	51741	10	53400	16	54720	12	56600	42	58691	23	61010	29	64384	37
50880	8	52100	11	53410	16	54730	12	56710	12	58692	22	61020	29	64385	34
51060	8	52120	11	53420	16	54750	12	56720	12	58693	24	61030	29	64386	33
51070	8	52130	11	53430	16	54760	12	56730	12	58695	22	61040	29	64395	37
51080	8	52170	11	53440	16	54780	12	56740	12	58700	23	61050	29	64396	37
51090	8	52190	11	53450	16	55100	52: 115	56750	12	58704	20	61060	29	64400	36
51100	8	52220	11	53460	16	55150	52: 115	56770	12	58705	20	61070	29	64401	36
51110	8	52240	11	53470	16	55200	52: 115	56780	12	60880	28	61080	29	64402	32
51120	8	52270	11	53480	16	55210	52: 115	56790	12	60881	28	61090	29	64553	37
51130	8	52340	11	53490	16	55211	52: 115	57000	193	60882	28	61100	29	64554	37
51140	8	52560	11	53500	17	55212	52: 115	57010	193	60883	28	61110	29	64650	35
51150	8	52570	11	53520	17	55215	52: 115	57020	193	60884	28	61120	29	64654	31
51160	8	52580	11	53540	17	55216	52: 115	57030	193	60885	28	61130	29	64655	33
51170	8	52630	11	53560	17	55217	52: 115	57050	193	60886	28	61140	29	64658	32
51180	8	52652	10	53561	17	55220	52: 115	57091	195; 224	60887	28	61150	29	64660	33
51190	8	52653	10	53562	17	55221	52: 115	57092	196; 224	60888	28	61160	29	64950	31
51200	8	52654	10	53563	17	55222	52: 115	57097	196; 224	60889	28	61170	29	64951	31
51210	8	52655	10	53571	17	55250	52: 114	57100	194	60890	28	61210	29	65020	34
51220	8	52656	10	53572	17	55300	52: 114	57160	194	60891	28	61220	29	65022	33
51240	8	52657	10	53573	17	55350	52: 114	57210	194	60910	31	61230	29	65023	33
51270	8	52658	10	53575	17	55500	119; 295; 418	57260	194	60912	28	61240	29	65025	33
51300	8	52659	10	53576	17	55505	119; 296; 419	57300	13	60913	28	61250	29	65033	34
51320	8	52660	10	53577	17	55531	119; 296; 419	57350	13	60914	28	61260	29	65034	32
51560	8	52661	10	53580	17	55541	119; 296; 419	57400	13	60915	28	61270	29	65040	31
51580	8	52680	11	53598	16	55542	119; 296; 419	57450	13	60916	28	61280	29	65041	31
51590	8	52700	11	53599	16	55544	119; 296; 419	57451	13	60917	28	61290	29	65045	35
51620	8	52710	11	53600	16	55545	119; 296; 419	57600	191	60918	28	61300	30	65080	32
51630	8	52720	11	53610	16	55620	52: 115	57610	191	60920	28	61310	30	65100	35
51640	8	52730	11	53630	16	55625	52: 115	57612	192	60921	28	61320	30	65105	32
51645	8	52740	11	53650	16	55630	52: 115	57613	192	60922	28	61330	30	65120	34
51650	8	52750	11	53670	16	55635	52: 115	57614	192	60923	28	61340	30	65123	34
51671	9	52770	11	53700	17	55645	52: 115	57620	192	60924	28	61350	30	65124	34
51672	9	52790	11	53710	17	55660	52: 115	57630	192	60930	31	61360	30	65150	35
51673	9	52820	11	53730	17	55690	52: 115	57640	192	60931	28	61370	30	65170	32
51674	9	52840	11	53760	16	55740	116	57649	192	60932	28	61375	30	65233	57
51675	9	52841	11	54000	12	55792	53; 115	57650	192	60933	28	61376	30	65235	57
51676	9	52842	11	54061	13	55800	114	57651	192	60934	28	61377	30	65260	194
51677	9	52843	11	54062	13	55820	114	57700	194	60935	28	61378	30	65270	194
51678	9	52844	11	54063	13	55830	144	58140	19	60936	28	61379	30	65520	38
51679	9	52845	11	54065	13	56040	40	58150	19	60937	28	61380	30	65610	38
51680	9	52846	11	54066	13	56050	40	58160	18	60938	28	61381	30	65620	38
51681	9	52860	11	54067	13	56060	40	58210	18	60939	28	61382	30	65630	38
51682	9	52900	12	54068	13	56070	40	58240	18	60950	28	61383	30	65640	38
51683	9	52933	12	54070	13	56080	40	58260	18	60951	28	61384	30	65650	38
51684	9	52935	12	54071	13	56100	40	58520	18	60952	28	61385	30	65700	37
51685	9	52936	12	54072	13	56120	40	58539	189	60953	28	61386	30	65800	38
51686	9	53002	16	54073	13	56130	40	58540	188	60954	28	61392	30	65850	40
51687	9	53003	16	54080	13	56140	40	58600	18	60955	28	61393	30	65880	36
51688	9	53080	16	54081	13	56170	40	58602	18	60956	28	61394	30	66080	39
51689	9	53100	16	54499	53; 115	56380	40	58633	19	60957	28	61395	30	66112	39
51690	9	53120	16	54500	53; 115	56390	40	58634	19	60958	28	61550	30	66113	40
51691	9	53130	16	54510	53; 115	56391	40	58640	19	60959	28	61560	30	66200	39
51692	9	53140	16	54600	12	56392	40	58641	19	60961	28	61580	30	66210	39
51693	9	53150	16	54610	12	56393	40	58642	20	60962	28	61590	30	66330	38
51694	9	53160	16	54620	12	56400	40	58643	20	60963	28	61600	30	66400	38
51695	9	53170	16	54630	12	56470	41	58645	20	60964	28	61640	31	66410	38
51696	9	53180	16	54640	12	56473	41	58661	20	60965	28	64050	35	66570	38
51705	9	53190	16	54650	12	56475	41	58683	21	60966	28	64060	35	66580	38
51710	9	53210	16	54660	12	56477	41	58685	22	60967	28	64070	35	66710	39
51715	9	53220	16	54670	12	56478	41	58686	21	60968	28	64090	35	66720	39
51720	9	53240	16	54680	12	56505	41; 279	58687	21	60969	28	64310	36	66760	39
51721	9	53270	16	54690	12	56506	41; 279	58688	23	60970	28	64330	37	66770	39
51722	9	53300	16	54700	12	56507	42; 279	58689	21	60975	28	64370	36	67260	157; 290; 381

69330	410	69635	132: 169	71834	408	72535	326	72872	320	72989	285	73529	126	73897	127
69331	411	69637	132: 169	71835	408	72570	327	72873	320	72990	285	73530	126	73898	127
69332	412	69850	387	71836	408	72572	327	72874	320	72994	287	73532	126	73906	127
69333	412	69851	387	71837	408	72573	327	72875	320	72995	287	73533	126	73909	127
69334	413	70000	122	71838	408	72615	326	72876	320	72996	287	73534	126	73929	127
69337	410	70020	122	71840	409	72616	326	72877	320	72997	287	73535	126	74000	310
69338	411	70023	122	71841	409	72617	326	72881	320: 381	72998	287	73536	126	74004	310
69339	412	70030	122	71842	409	72620	326	72882	320: 381	73002	285	73539	126	74077	313
69340	412	70035	122	71843	409	72621	326	72883	320: 381	73003	285	73540	126	74078	313
69341	413	70050	122	71844	409	72622	326	72884	320: 381	73004	286	73561	126	74079	313
69344	411	70100	122	71846	409	72625	326	72885	320: 381	73005	286	73562	126	74080	313
69345	411	70160	122	71847	409	72626	326	72886	320: 381	73006	286	73563	126	74081	313
69346	412	70201	123	71848	409	72627	326	72887	320: 381	73040	232	73565	126	74082	313
69347	413	70210	123	71849	409	72630	326	72888	320: 381	73051	232	73567	126	74094	310
69348	413	70270	123	71850	409	72631	326	72890	321	73052	227	73568	126	74100	310: 379
69350	411	70320	123	71851	409	72632	326	72891	321	73056	227	73569	126	74102	310
69351	411	70330	123	71852	409	72683	321	72900	322: 384	73057	227	73570	126	74103	310
69352	412	70340	123	71853	409	72684	321	72901	322: 384	73060	232	73571	126	74104	310
69353	413	70400	123	71854	409	72685	321	72902	322: 384	73205	248	73572	126	74106	310
69354	413	70410	123	71855	409	72686	321	72903	322: 384	73206	248	73573	126	74107	310
69357	411	70420	123	71856	409	72801	321	72920	293	73207	248	73574	126	74108	310
69358	411	70430	123	71857	409	72802	321	72921	295	73208	248	73575	126	74110	311: 379
69359	412	70480	123	71858	409	72803	321	72922	295	73260	128: 243	73590	126	74113	312: 380
69360	412	70490	123	71859	409	72804	321	72928	294	73270	128: 243	73598	126	74115	312: 380
69361	413	70500	123	71860	409	72805	321	72931	295	73271	128: 243	73612	127	74117	311: 380
69362	413	70510	123	72040	124	72806	321	72932	295	73300	127: 243	73614	127	74121	311: 380
69363	414	71000	123	72060	124	72807	321	72933	286	73325	142	73616	127	74123	311: 380
69400	414	71040	124	72080	124	72808	321	72934	286	73330	142	73620	127	74125	311: 379
69401	414	71050	124	72100	124	72809	321	72935	286	73331	142	73621	127	74126	311: 379
69402	414	71052	124	72120	124	72821	321	72936	286	73332	143	73625	127	74127	311: 379
69403	414	71060	124	72140	124	72822	321	72937	286	73340	143	73627	127	74128	311: 380
69404	414	71080	124	72400	328	72823	321	72938	287	73341	143	73632	127	74130	311: 379
69405	414	71160	124	72401	328	72824	321	72939	287	73342	143	73640	127	74131	311: 379
69406	414	71800	408	72402	328	72825	321	72942	287	73343	143	73645	127	74132	311: 379
69407	415	71801	408	72404	327	72826	321	72943	287	73344	143	73660	127	74133	311: 379
69408	415	71802	408	72407	327	72827	321	72944	287	73350	144	73670	127	74134	311: 379
69502	131: 169	71803	408	72451	327	72828	321	72945	287	73351	144	73680	127	74135	311: 379
69503	131: 169	71804	408	72452	327	72829	321	72948	286	73352	144	73695	127	74136	311: 380
69504	131: 169	71805	408	72455	327	72831	319: 380	72950	286	73353	144	73700	127	74137	311: 380
69505	131: 169	71807	408	72484	326	72832	319: 380	72951	286	73360	144	73710	127	74140	313
69506	131: 169	71808	408	72486	326	72833	319: 380	72952	286	73362	144	73720	127	74145	312
69507	131: 169	71809	408	72489	326	72834	319: 380	72953	287	73400	117: 141	73730	127	74146	312
69508	131: 169	71810	408	72490	326	72835	319: 380	72954	287	73403	118: 141	73740	127	74148	313
69509	131: 169	71811	408	72493	326	72836	319: 380	72956	287	73410	117: 142	73775	127	74149	313
69510	131: 169	71812	408	72494	326	72840	320: 381	72958	287	73412	117: 142	73820	127	74150	312
69521	132: 169	71814	408	72500	326	72841	320: 381	72960	287	73413	117: 142	73831	126	74151	312
69539	132: 170	71815	408	72501	326	72842	320: 381	72963	287	73420	117: 141	73833	126	74152	313
69540	132: 170	71816	408	72504	326	72843	320: 381	72964	287	73470	241	73835	126	74153	313
69542	132: 170	71817	408	72505	326	72844	320: 381	72965	287	73473	242	73836	126	74154	313
69543	132: 170	71818	408	72506	326	72845	320: 381	72966	287	73500	243	73838	126	74160	312
69546	132: 170	71819	408	72508	326	72846	320: 381	72967	287	73506	127: 348	73881	127	74162	312
69550	132: 170	71820	408	72509	326	72850	320: 381	72968	287	73507	127: 348	73882	127	74190	319: 382
69551	132: 170	71821	408	72510	326	72851	320: 381	72969	287	73508	127: 348	73883	127	74191	319: 382
69552	132: 170	71822	408	72524	326	72852	320: 381	72970	287	73510	127: 348	73884	127	74192	319: 382
69572	132: 169	71823	408	72525	326	72853	320: 381	72974	288	73511	127: 348	73885	127	74193	319: 382
69608	132: 170	71824	408	72526	326	72854	320: 381	72975	288	73515	126	73886	127	74194	319: 382
69609	132: 170	71825	408	72527	326	72858	320: 381	72976	288	73516	126	73887	127	74195	319: 382
69610	132: 170	71827	408	72528	326	72859	320: 381	72977	288	73517	126	73888	127	74220	323
69612	132: 170	71828	408	72529	326	72860	320: 381	72978	288	73521	126	73891	127	74221	323
69613	132: 170	71829	408	72530	326	72861	320: 381	72979	288	73522	126	73892	127	74222	323
69620	132: 169	71830	408	72531	326	72862	320: 381	72981	288	73523	126	73893	127	74223	323
69621	132: 169	71831	408	72532	326	72863	320: 381	72984	288	73525	126	73894	127	74255	248
69630	132: 169	71832	408	72533	326	72864	320: 381	72985	288	73527	126	73895	127	74307	248
69631	132: 169	71833	408	72534	326	72871	320	72988	285	73528	126	73896	127	74311	248

No.	Page	No.	Page	No.	Page	No.	Page	No.	Page	No.	Page	No.	Page	No.	Page
74316	248	74661	322	74887	302	75300	128; 159	75535	406	75748	397	76751	300	77241	260
74400	249; 315	74662	322	74910	302	75301	128; 159	75536	406	75749	397	76752	299	77250	260
74410	249; 315	74663	322	74911	302	75302	128; 159	75537	406	75760	395	76755	300	77300	260
74411	249; 315	74664	322	74912	302	75303	128; 159	75539	406	75762	395	76756	300	77350	260
74420	249	74665	322	74913	302	75304	128; 159	75540	402	75763	395	76757	299	77400	260
74421	249	74666	322	74914	302	75327	399	75541	402	75764	396	76760	300	77500	260
74422	249	74667	322	74920	303	75328	400	75543	402	75765	396	76761	300	77600	260
74430	249	74680	307	74921	303	75329	400	75544	402	75767	396	76762	299	77603	260
74431	249	74681	307	74922	303	75330	401	75545	402	75768	396	76765	300	77607	261
74432	249	74685	307	74923	303	75331	401	75548	403	75705	398	76766	300	77700	261
74435	251; 316	74688	307	74924	303	75332	401	75550	403	75706	398	76767	299	77715	280
74439	252; 318	74689	307	74935	303	75333	401	75551	403	75707	398	76800	243	77795	279
74440	249; 315	74730	303	74936	303	75360	399	75552	403	75708	398	76801	243	77815	266; 277
74441	250; 316	74731	304	74960	303	75361	399	75553	406	75709	398	76806	243	77830	265; 276
74442	250; 316	74732	304	74973	307	75362	399	75554	406	75770	394	76807	243	77831	265; 276
74443	250; 316	74733	304	74974	307	75363	399	75555	409	75772	395	76810	243	77833	265; 276
74447	250; 316	74734	304	74975	307	75364	399	75556	409	75773	395	76811	244	77834	265; 276
74448	250; 316	74740	304	74983	307	75365	399	75558	410	75774	395	76814	244	77835	265; 276
74449	251; 317	74741	304	75000	130	75366	399	75559	410	75911	415	76815	244	77837	265; 276
74450	250; 316	74742	304	75012	130	75367	399	75564	406	75912	415	76818	244	77838	265; 276
74451	251; 317	74743	304	75028	130	75368	399	75565	406	75914	415	76819	244	77840	265; 277
74452	251; 318	74744	305	75031	130; 159	75369	399	75570	407	75915	303; 417	76822	244	77845	265; 276
74453	251; 318	74750	305	75035	131	75370	399	75572	407	75916	303; 417	76823	244	77850	266; 277
74454	251; 318	74751	305	75036	131	75371	399	75573	407	75930	418	76826	244	77860	266; 277
74455	251; 318	74752	305	75050	130	75372	399	75574	407	75931	418	76827	244	77861	266; 277
74456	251; 318	74753	305	75060	130	75373	399	75578	407	75932	418	76830	244	77870	266; 277
74457	251; 316	74754	305	75100	129; 159	75374	399	75579	407	75945	417	76832	244	77872	266; 277
74459	313	74760	305	75120	129; 158	75375	399	75595	407	75970	415	76835	244	77881	266; 277
74460	314	74765	305	75121	129; 158	75376	399	75596	407	75971	415	76836	244	77900	264
74461	317; 382	74766	306	75122	129; 158	75377	399	75597	407	75972	415	77004	259	77910	264
74462	317; 383	74771	306	75123	129; 158	75378	399	75598	407	75973	416	77005	259	77920	264
74463	317	74772	306	75124	129; 158	75379	399	75599	407	76000	101	77006	259	77921	265
74464	317	74773	306	75125	129; 158	75380	399	75619	405	76010	101	77051	259	77930	265
74466	318	74775	306	75130	129; 158	75381	400	75620	405	76011	102	77052	259	78000	190
74467	318	74776	306	75131	129; 158	75382	400	75621	405	76015	102	77053	259	78020	295
74480	251; 317	74777	306	75132	129; 158	75383	400	75622	405	76160	102	77054	259	78021	295
74501	314; 383	74802	300	75133	129; 158	75384	400	75623	405	76180	102	77055	259	78022	295
74502	314; 383	74804	300	75140	130; 158	75386	400	75624	405	76181	102	77061	259	78027	128
74503	314; 383	74812	300	75141	130; 158	75387	400	75625	404	76182	102	77062	259	78030	190
74504	314; 383	74816	301	75200	118	75388	400	75626	403	76183	103	77063	259	78031	191
74508	314; 383	74818	301	75201	118	75389	400	75627	403	76184	102	77064	259	78035	191
74509	314; 384	74820	301	75202	118	75421	400	75628	404	76185	102	77110	260	78040	189
74540	314	74828	301	75230	130	75422	400	75629	403	76190	103	77120	260	78041	189
74541	315	74831	301	75231	130	75423	400	75631	403	76210	103	77130	260	78042	189
74542	315	74833	301	75233	130	75424	400	75632	404	76214	103	77140	260	78043	190
74543	315	74835	301	75238	129; 158	75448	400	75633	404	76220	103	77150	260	78044	191
74555	315	74838	301	75239	129; 158	75449	400	75634	404	76230	103	77170	261	78045	190
74580	319; 383	74841	301	75240	129; 158	75450	400	75635	404	76250	103	77171	261	78046	189
74581	319; 383	74843	301	75245	129; 158	75451	400	75636	404	76280	103	77180	261	78047	190
74600	318; 381	74846	301	75246	129; 158	75455	417	75637	404	76305	104	77190	261	78050	190
74601	319; 382	74849	301	75247	129; 158	75465	416	75638	405	76311	104	77191	261	78061	190
74602	319; 382	74851	302	75260	129; 158	75466	416	75639	405	76312	104	77192	261	78067	190
74610	318; 382	74853	302	75261	129; 158	75467	416	75660	410	76314	104	77193	261	78068	190
74622	318; 382	74855	302	75262	129; 158	75468	416	75661	410	76320	57	77200	261	78101	219
74624	318; 382	74856	302	75270	128; 157	75469	417	75685	397	76526	101	77203	261	78102	219
74626	322	74858	301	75271	128; 157	75470	417	75686	397	76621	101	77204	261	78105	220
74627	322	74861	302	75272	128; 157	75483	401	75687	397	76622	101	77205	261	78106	220
74628	322	74863	302	75273	128; 157	75484	401	75688	397	76640	101	77210	260	78110	220
74631	322	74866	302	75274	128; 157	75485	402	75689	398	76650	101	77211	260	78111	220
74632	322	74869	302	75285	128; 157	75487	402	75740	394	76660	101	77212	260	78112	220
74633	322	74882	302	75286	128; 157	75488	402	75742	394	76700	105	77213	260	78115	220
74646	322	74883	302	75287	128; 157	75498	401	75743	394	76705	105	77230	260	78116	221
74647	322	74885	302	75288	128; 157	75499	401	75745	396	76710	105	77231	260	78121	221
74660	322	74886	302	75295	128	75527	406	75747	396	76750	300	77232	260	78122	221

No.	Page	No.	Page	No.	Page	No.	Page	No.	Page	No.	Page	No.	Page	No.	Page
78123	221	78626	259	78990	224	79386	243	79927	236; 351	80600	192	81647	180	82393	208
78124	221	78628	259	78992	218	79390	244	79928	236; 351	80601	193	81650	178	82395	208
78127	221	78630	259	78995	218	79391	245	79929	236; 351	80620	193	81653	178	82397	209
78128	222	78632	259	78997	218	79395	245	79930	236; 351	80640	193	81661	178	82400	208
78130	222	78633	259	79007	218	79398	244	79931	236; 351	80660	194	81761	172	82431	205
78150	219	78641	258	79013	214	79420	226	79932	236; 351	80661	194	81762	172	82440	204
78154	223	78642	258	79015	230	79442	237; 376	79933	236; 351	80751	202	81771	172	82445	205
78157	224	78660	297	79023	218	79444	237; 376	79943	229; 350	80752	202	81780	57	82501	205
78300	191	78661	297	79036	219	79448	237; 376	79960	348	80753	202	81781	172	82502	205
78303	191	78700	270	79046	230	79467	236; 375	79962	348	80901	178	81782	172	82504	205
78306	191	78710	270	79048	214	79468	239; 377	79963	348	80902	178	81783	57	82506	205
78341	116	78720	270	79049	218	79473	226	79965	348	80970	177	81784	57	82520	205
78381	116	78730	270	79053	219	79474	226	79968	348	81100	176	81785	172	82550	202
78385	116	78750	270	79054	219	79476	226	79971	348	81101	176	81820	195	82551	202
78400	194	78785	271	79087	223	79479	231	79973	348	81107	176	81823	195	82552	202
78401	195	78790	271	79088	223	79481	231	79975	348	81108	176	81824	195	82553	202
78405	195; 332	78791	271	79089	223	79482	226	79977	245	81109	176	81825	195	82555	201
78432	258	78793	271	79094	224	79491	225	79978	245	81110	176	81830	189	82610	202
78434	258	78794	271	79095	225	79493	230	79979	245	81114	177	82000	202; 278	82611	202
78436	258	78800	270	79099	215	79500	234; 375	79982	245	81115	177	82001	203; 278	82650	202
78450	306	78801	270	79118	215	79501	234; 375	79983	245	81117	177	82005	202; 278	82671	327; 388
78451	307	78802	270	79119	225	79510	234; 375	79984	245	81118	177	82015	203; 278	82673	327; 388
78463	264	78811	270	79123	215	79520	234; 376	79990	245	81119	177	82020	203; 278	82675	327; 388
78480	262	78812	270	79150	230	79530	234; 376	79991	245	81133	178	82021	203; 278	82677	327
78481	262	78813	270	79151	225	79531	234; 376	79992	245	81142	178	82022	203; 279	82682	327
78482	262	78814	270	79205	229	79550	238; 377	79993	245	81370	185	82031	278	82684	327
78490	262	78815	270	79206	229	79551	238; 377	79994	245	81371	185	82032	278	82685	327
78491	263	78816	271	79207	229	79552	239; 377	79996	245	81372	185	82200	204	82687	327
78501	263	78818	271	79237	216	79570	241	79997	245	81373	185	82201	203	82699	197; 331
78511	263	78819	271	79239	216	79572	241	79998	245	81374	185	82205	203	82705	197; 331
78520	263	78821	271	79240	225	79580	241	80001	245	81378	185	82206	204	82706	197; 331
78525	264	78822	271	79252	216	79600	241	80002	245	81379	185	82209	203	82712	198; 331
78526	264	78824	271	79253	216	79620	241	80012	199	81380	185	82225	204	82713	197; 331
78540	284	78825	271	79255	215	79630	241	80022	199	81387	185	82231	204	82714	198; 331
78541	284	78826	271	79256	241	79640	242	80032	199	81390	185	82232	204	82715	197; 331
78542	284	78830	272	79275	216	79641	242	80042	199	81391	185	82233	204	82716	198; 332
78543	284	78831	272	79309	225	79766	227	80052	199	81399	185	82234	204	82717	198; 332
78555	284	78832	272	79314	230	79771	235; 350	80062	199	81400	185	82300	207	82719	196; 330
78556	284	78833	272	79318	231	79772	235; 350	80072	199	81401	185	82301	207	82720	196; 330
78557	284	78834	272	79320	227	79773	235; 350	80082	199	81490	184	82305	207	82723	197; 331
78570	284	78835	272	79324	231	79774	235; 350	80111	200	81491	184	82308	207	82724	198; 332
78571	284	78854	228	79325	231	79775	235; 350	80120	200	81492	184	82310	207	82726	198; 332
78572	284	78870	294	79327	227	79781	229; 349	80121	200	81500	184	82315	207	82728	196; 330
78575	284	78871	238; 294	79328	227	79782	229; 349	80220	200	81501	184	82320	207	82729	196; 330
78576	284	78873	228; 294	79332	226	79783	229; 349	80233	200	81502	184	82331	208	82730	198; 332
78577	284	78910	117; 216	79334	231	79790	235; 350	80252	200	81519	184	82341	208	82731	198; 332
78580	284	78911	116; 233	79346	242	79791	235; 350	80271	200	81520	184	82343	209	82735	198; 332
78581	284	78912	116; 229	79350	238	79792	235; 350	80300	200	81521	184	82351	208	82742	199; 332
78582	284	78960	214	79351	238	79800	235; 241	80307	201	81522	184	82355	71	82756	199; 333
78585	284	78961	223	79354	228	79810	235; 350	80308	201	81523	184	82360	207	82771	328
78586	284	78968	223	79355	233	79811	235; 350	80309	201	81524	184	82370	207	82772	328
78587	284	78970	214	79358	238	79812	235; 350	80312	201	81525	184	82372	208	82786	328
78590	285	78971	214	79365	228	79861	377	80320	201	81527	184	82373	208	82787	328
78591	285	78972	223	79366	228	79862	377	80330	201	81553	184	82374	208	82788	328
78592	285	78974	223	79367	228	79863	377	80340	201	81556	184	82375	208	82789	328
78611	258	78975	215	79368	228	79865	377	80350	201	81560	184	82377	208	82790	328
78612	258	78976	215	79373	232	79866	377	80402	201	81562	184	82378	208	82791	328
78613	258	78978	215	79374	233	79867	377	80412	201	81617	178	82379	208	82841	329
78614	259	78981	222	79376	228	79869	377	80450	201	81618	179	82380	208	82842	329
78615	259	78982	222	79377	228	79880	350	80500	192	81634	179	82384	208	82843	329
78616	259	78983	222	79378	228	79912	235; 350	80510	192	81637	179	82386	208	82844	329
78620	258	78985	222	79382	232	79913	235; 350	80520	192	81638	179	82388	208	82845	329
78622	258	78986	222	79383	232	79919	240	80530	192	81640	179	82390	208	82846	329
78624	258	78987	222	79385	232	79926	236; 351	80534	192	81644	179	82392	208	82847	330

No.	Page	No.	Page	No.	Page	No.	Page	No.	Page	No.	Page	No.	Page	No.	Page
82848	330	87313	297	88673	334	89192	344	89281	342	89471	240; 378	99109	353	99462	67; 357
82910	205	87315	297	88674	334	89193	343	89282	342	89472	240; 378	99110	354	99463	67; 358
82920	205	87317	297	88675	334	89194	343	89298	348	89473	240; 379	99111	353	99464	67; 358
82939	205	87321	297	88676	334	89195	344	89299	348	89474	240; 379	99112	354	99512	388
82941	243	87322	297	88677	333	89200	342	89300	348	89475	240; 379	99115	354	99513	388
82942	230	87323	297	88678	333	89201	342	89302	348	89478	240; 379	99116	353	99514	389
82951	206; 294	87325	297	88700	384	89202	342	89303	348	89479	240; 379	99180	353	99519	389
83000	205	87327	297	88701	384	89203	345	89305	348	89480	240; 379	99181	353	99520	389
83001	206	87331	297	88702	384	89204	345	89307	348	89481	240; 379	99182	353	99524	390
83002	206	87332	297	88703	384	89206	345	89308	348	89482	240; 379	99190	351	99568	390
83004	206	87333	297	88704	384	89207	345	89310	348	89483	240; 379	99191	352	99575	390
83005	206	87335	297	88705	384	89208	345	89311	348	89484	240; 379	99193	351	99576	391
83120	335	87337	297	88801	384	89209	344	89312	348	89485	240; 379	99194	351	99580	389
83121	335	87351	298	88805	384	89210	343	89313	348	89486	240; 379	99202	352	99581	389
83122	335	87352	298	88806	384	89211	344	89314	348	89507	372	99203	352	99584	389
83123	335	87353	298	88809	384	89213	343	89315	348	89508	372	99204	352	99640	388
83124	335	87354	298	88811	385	89214	343	89316	348	89509	372	99207	352	99641	388
83260	206	87361	298	89000	385	89215	344	89318	348	89515	373	99208	352	99710	390
83261	206	87362	298	89001	338	89218	346	89319	348	89518	373	99209	352	99711	390
83262	207	87363	298	89002	338	89220	344	89320	348	89520	373	99210	352	99712	390
83266	207	87364	298	89003	338	89221	338	89330	348	89526	373	99230	351	GV-0062	180
83267	207	87371	298	89004	338	89222	338	89331	348	89528	373	99240	353	GV-0082	180
83270	206	87372	298	89007	339	89223	338	89335	349	89536	373	99300	355	GV-0083	180
83280	207	87373	298	89008	339	89224	338	89336	349	89537	373	99301	355	GV-0400	180
85020	209; 293	87374	298	89011	339	89225	338	89342	349	89538	374	99310	354	GV-0420	180
85030	209; 293	87381	298	89013	340	89226	338	89345	349	89539	374	99315	354	GV-0510	180
85040	209; 293	87382	298	89015	340	89227	338	89351	345	89540	374	99351	347	GV-0610	180
85050	209; 293	87383	298	89017	341	89228	338	89390	346	89541	374	99390	367	GV-0620	181
85060	209; 293	87384	298	89018	341	89229	339	89401	239; 377	89542	374	99391	367	GV-0631	181
85080	209; 293	87391	298	89020	341	89230	339	89402	239; 377	89543	374	99400	366	GV-0656	181
85090	209; 293	87392	298	89022	342	89231	339	89403	239; 377	89545	374	99401	368	GV-0658	181
85100	209; 293	87393	298	89070	338	89232	339	89404	239; 377	89546	374	99402	370	GV-0700	181
85112	209; 293	87401	298	89071	338	89233	339	89405	239; 377	89547	375	99403	370	GV-0710	181
85113	209; 293	87402	298	89072	338	89234	339	89406	239; 377	89552	349	99404	370	GV-0720	181
85114	209; 293	87403	298	89073	338	89235	340	89411	239; 378	89553	349	99405	372	GV-0730	181
85115	209; 293	87411	299	89074	339	89236	340	89412	239; 378	89560	160; 385	99406	372	GV-0740	181
85116	209; 293	87412	299	89075	339	89239	339	89413	239; 378	89561	160; 385	99407	371	GV-0861	182
85118	209; 293	87413	299	89076	340	89240	339	89414	239; 378	89562	160; 385	99408	370	GV-0871	182
85119	209; 293	87422	299	89077	340	89241	340	89415	239; 378	89563	160; 385	99409	371	GV-0925	182
85120	209; 293	87423	299	89078	341	89242	340	89416	239; 378	89564	160; 385	99410	370	GV-1100	182
85122	209; 293	87425	299	89079	341	89243	341	89421	239; 378	89880	360	99412	371	GV-1101	182
85123	209; 293	87427	299	89080	340	89244	341	89422	239; 378	99005	354	99413	371	GV-1102	182
85124	209; 293	87431	299	89083	341	89245	341	89423	239; 378	99006	354	99415	370	GV-1105	182
85125	209; 293	87432	299	89090	343	89246	341	89424	239; 378	99007	354	99416	371	GV-1121	182
85126	209; 293	87433	299	89100	338	89247	342	89425	239; 378	99008	354	99418	371	GV-1122	182
85128	209; 293	87435	299	89101	338	89248	342	89426	239; 378	99028	360	99419	371	GV-1123	182
85129	209; 293	87437	299	89102	338	89251	340	89441	239; 378	99033	360	99420	371	GV-1150	182
85130	209; 293	87451	299	89103	338	89252	340	89442	239; 378	99034	359	99425	372	GV-1151	182
86700	296	87452	299	89104	339	89253	339	89443	239; 378	99035	359	99426	372	GV-1152	182
86701	296	87453	299	89105	339	89255	345	89444	239; 378	99036	359	99427	372	GV-1160	182
86750	118	87454	299	89106	340	89256	345	89452	239; 378	99037	359	99428	372	GV-1161	182
86751	118	87455	299	89107	340	89260	347	89453	239; 378	99038	359	99429	372	GV-1180	183
86752	118	87456	299	89108	341	89261	346	89454	239; 378	99039	360	99430	372	GV-1181	183
86760	118	87457	299	89109	341	89262	346	89456	239; 378	99040	360	99435	372	GV-1182	183
86761	118	87600	296	89110	340	89263	346	89457	239; 378	99047	358	99436	372	GV-1200	183
86770	118	88411	276; 334	89112	342	89265	347	89458	239; 378	99048	358	99438	372	GV-1201	183
86771	118	88421	276; 335	89113	341	89266	347	89459	239; 378	99049	358	99440	372	GV-1202	183
87301	297	88422	276; 335	89120	343	89267	347	89462	240; 378	99050	358	99442	372	GV-1220	183
87302	297	88550	199; 333	89180	344	89268	347	89463	240; 378	99051	358	99443	372	GV-1221	183
87303	297	88555	199; 333	89181	345	89269	347	89464	240; 378	99052	358	99444	372	GV-1240	183
87305	297	88560	199; 333	89187	342	89270	346	89465	240; 378	99053	360	99445	372	GV-1241	183
87307	297	88670	334	89189	343	89272	346	89466	240; 378	99054	360	99446	372	GV-1242	183
87311	297	88671	334	89190	344	89273	347	89467	240; 378	99056	360	99460	67; 357	GV-1272	183
87312	297	88672	334	89191	345	89280	348	89470	240; 378	99103	353	99461	67; 357	GV-1382	183

No.	Page
GV-1384	183
GV-1385	183

No.	Page
GV-1386	183
GV-1387	183

No.	Page
GV-1388	183
GV-1582	183

No.	Page
GV-1583	183

Memo

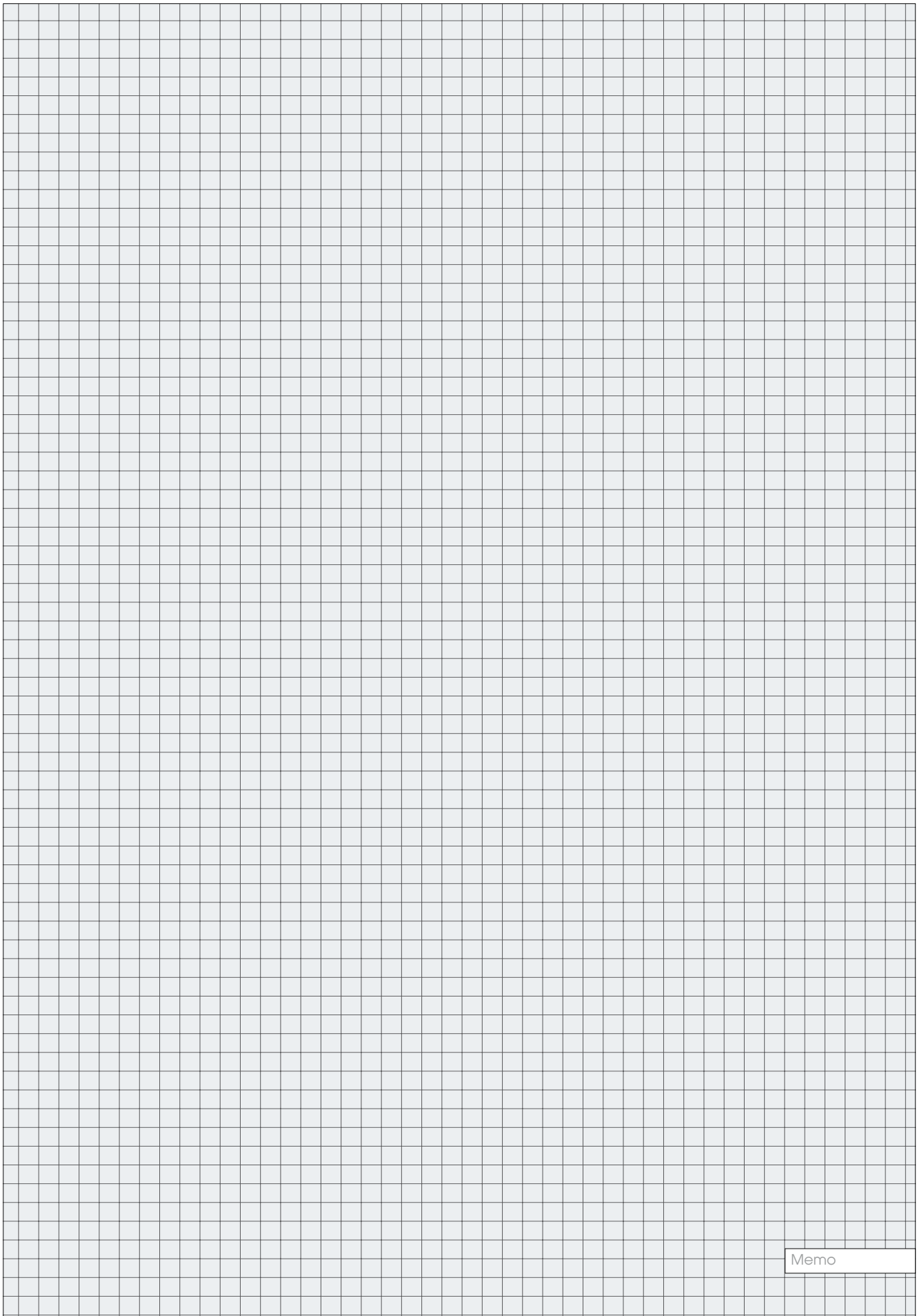

Memo

PL

I. TOYA S.A. informuje, iż:

- 1) niniejszy katalog nie stanowi oferty w rozumieniu prawa cywilnego;
- 2) prezentowane w niniejszym katalogu artykuły mogą w rzeczywistości odbiegać od wskazanego na zdjęciach wzoru, w szczególności jeżeli chodzi o cechy zewnętrzne, tj. wielkość, kolor, sposób opakowania, ilość przedmiotów w opakowaniu;
- 3) nie ponosi odpowiedzialności za drobne różnice w sposobie pakowania czy właściwościach artykułów pozostających bez wpływu na jego przeznaczony cel lub sposób użytkowania;
- 4) nie ponosi odpowiedzialności wynikającej z jakichkolwiek niedokładności lub nieścisłości, co do informacji zawartych w przedmiotowym katalogu;
- 5) nie ponosi odpowiedzialności za ewentualną szkodę powstałą w wyniku otrzymania towaru o innych właściwościach niż prezentowany na zdjęciach.

II. Pomimo najlepszych starań poczynionych przez TOYA S.A. nie może ona zagwarantować, iż informacje zawarte w niniejszym katalogu w pełni odpowiadają rzeczywistości.

III. Wszelkie decyzje podjęte na podstawie informacji zawartych w przedmiotowym katalogu podejmowane są na własne ryzyko osoby, która korzysta z tych informacji.

GB

I. TOYA S.A. informs that:

- 1) the present catalogue does not constitute an offer as construed in the civil law;
- 2) the goods presented in the present catalogue may in fact differ from the models shown in the pictures, particularly as far as external properties are concerned, namely size, colour, packaging, number of items in the package;
- 3) the company will not be held responsible for small differences in packaging or properties of the goods, which do not affect the purpose or the exploitation of the tools;
- 4) the company will not be held responsible for any inaccuracies or imprecision regarding the information presented in the catalogue;
- 5) the company will not be held responsible for any damage caused by goods whose properties differ from those of the tools presented in the photographs.

II. In spite of all the efforts made by TOYA S.A., the company cannot guarantee the information contained in the present catalogue fully correspond to the reality.

III. Any decisions made on the basis of the information contained in the present catalogue will be made at the risk of the person who makes them using the aforementioned information.

D

I. TOYA S.A. informiert, dass:

- 1) der vorliegende Katalog kein Angebot im zivilrechtlichen Sinne darstellt;
- 2) die im vorliegenden Katalog präsentierten Artikel in der Realität von den auf den Musterfotos gezeigten abweichen können, und zwar besonders dann, wenn es um äußere Eigenschaften geht, wie z.B. Größe, Farbe, Art der Verpackung, Anzahl der Gegenstände in der Verpackung;
- 3) sie keine Verantwortung für geringfügige Unterschiede bei der Verpackungsart oder den Eigenschaften der Artikel übernimmt, die ohne Auswirkungen auf seinen Bestimmungszweck oder die Art der Nutzung bleiben;
- 4) sie keine Verantwortung für irgendwelche Oberflächlichkeiten und Ungenauigkeiten bzgl. der im Sachkatalogkatalog enthaltenen Informationen übernimmt;
- 5) sie keine Verantwortung für eventuelle Schäden, die im Ergebnis des Erhalts der Ware mit anderen als auf den Fotos dargestellten Eigenschaften entstanden sind, übernimmt.

II. Trotz großer Bemühungen seitens TOYA S.A. kann die Firma nicht garantieren, dass die im vorliegenden Katalog enthaltenen Informationen voll der Realität entsprechen.

III. Sämtliche Entscheidungen, die auf der Grundlage der im Sachkatalog enthaltenen Informationen getroffen wurden, gehen auf das Risiko der Person, die diese Informationen benutzt.

RUS

I. TOYA S.A. заявляет:

- 1) настоящий каталог не является торговым предложением с точки зрения гражданского законодательства;
- 2) изделия, представленные в настоящем каталоге, могут отличаться от образцов на снимках, особенно внешним видом, то есть размером, цветом, способом упаковки, количеством предметов в упаковке;
- 3) производитель не отвечает за мелкие отличия в способе упаковки или свойствах изделий, которые не влияют на предназначение или способ пользования изделиями;
- 4) производитель не отвечает за мелкие неточности в сведениях из предметного каталога;
- 5) производитель не отвечает за ущерб, нанесенный вследствие поставки товара, отличающегося параметрами от указанного на снимках.

II. Несмотря на все усилия в данном направлении, компания TOYA S.A. не гарантирует, что информация, метящаяся в настоящем каталоге, полностью отвечает действительности.

III. Риск, связанный с любыми решениями, принятыми на основании информации из предметного каталога, берут на себя лица, пользующиеся указанной информацией.

UA

I. Інформація від виробника, TOYA S.A.:

- 1) цей каталог не є комерційною пропозицією з точки зору цивільного законодавства;
- 2) вироби, представлені у цьому каталозі, можуть відрізнятися від зображень на фотографіях, особливо зовнішнім виглядом, тобто розміром, кольором, способом упаковки, кількістю предметів в упаковці;
- 3) виробник не несе відповідальність за дрібні відмінності у способі упаковки чи властивостях виробів, які не мають впливу на їх призначення чи спосіб користування ними;
- 4) виробник не несе відповідальність за дрібні неточності у інформації, включеної у цей каталог;
- 5) виробник не несе відповідальність за можливі збитки, нанесені внаслідок отримання виробів, що своїми параметрами відрізняються від зображень на фотографіях.

II. Незважаючи на зусилля у даному напрямку, фірма TOYA S.A. не гарантує, що інформація, включена у цей каталог, повністю відповідає дійсності.

III. Приймаючи будь-які рішення на підставі інформації, включеної у цей каталог, не забувайте, що пов'язаний з ними ризик беруть на себе особи, що використовують включену у каталог інформацію.

LT

I. TOYA S.A. informuoja, kad:

- 1) šis katalogas nėra civilinės teisės supratimu pasiūlymas;
- 2) rodomos šame kataloge prekės gali tikrumoje skirtis nuo parodyto nuotraukose pavyzdžio, ypač jų išorine išvaizda ir požymiais, t.y. dydžiu, spalva, įpakavimo būdu, elementų kiekiu pakuotėje;
- 3) gamintojas neneša atsakomybės už nereikšmingus skirtumus įpakavime arba gaminio savybėse, kurios neturi įtakos jo paskirčiai arba jo vartojimo būdui.
- 4) neneša taip pat atsakomybės dėl bet kokių netikslumų arba nepakankamai preciziškų apibrėžimų pateiktoje kataloge informacijoje.
- 5) neneša atsakomybės už galimai patirtus nuostolius gavus prekę su savybėmis, kurios nėra tapačios su pateiktomis nuotraukose.

II. Nežiūrint geriausių TOYA S.A. pastangų, bendrovė negali garantuoti, kad pateikta šiame kataloge informacija pilnai atitinka tikrovę.

III. Bet kokie sprendimai priimami šiame kataloge pateiktą informaciją pagrindu yra besinaudojančio šia informacija asmens priimami savo paties rizika.

LV

I. A/S „TOYA“ informē, ka:

- 1) šis katalogs nav piedāvājums civillikuma izpratnē;
- 2) piedāvāti šī katalogā produkti realitātē var atšķirties no rādīta uz fotogrāfijas parauga, sevišķi ārēju īpašību sfērā, t.i. ar lielumu, krāsu, pakošanas veidu, priekšmetu skaitu iepakojumā;
- 3) nav atbildīga par smalkām atšķirībām iepakošanas veidā vai produktu īpašībām, ja tie neietekmē ierīces paredzētu mērķu vai lietošanas veidu;
- 4) nav atbildīga par kaut kādām neprecizitātēm informācijās, kas ir norādītas šī katalogā;
- 5) nav atbildīga par iespējamam zaudējumam, savienotiem ar produkta saņemšanu ar citām īpašībām, nekā rādītas uz fotogrāfijas.

II. Neskatoties uz visaugstāko rūpību, ar kuru A/S „TOYA“ sagatavoja savu katalogu, tā nevar garantēt, ka informācijas šī katalogā pilnīgi atbild realitātei.

III. Visi lēmumi, pieņemti pamatojoties uz informācijas no kataloga - ir pieņemti uz personas, kura lieto šo informāciju, risku.

CZ

I. TOYA S.A. informuje že:

- 1) tento katalog nepředstavuje nabídku ve smyslu občanského práva;
- 2) výrobky prezentované v tomto katalogu se mohou ve skutečnosti lišit od modelů uvedených na obrázcích, zejména co se týká vnějších znaků, tj. velikosti, barvy, způsobu balení, počtu předmětů v balení;
- 3) nenes odpovědnost za drobné rozdíly ve způsobu balení nebo ve vlastnostech výrobků, které nemají zásadní vliv na jejich určený účel nebo způsob používání;
- 4) nenes odpovědnost vyplývající z jakýchkoli nepřesností co do informací uvedených v předmětném katalogu;
- 5) nenes odpovědnost za případné škody vzniklé v důsledku obdržení zboží s jinými vlastnostmi, než je uvedeno na obrázcích.

II. Navzdory mimořádnému úsilí vynaloženému firmou TOYA S.A. tato nemůže garantovat, zda informace uvedené v tomto katalogu zcela odpovídají skutečnosti.

III. Veškerá rozhodnutí přijatá na základě informací uvedených v předmětném katalogu jsou přijímána na vlastní riziko osoby, která tyto informace využívá.

SK

I. TOYA S.A. informuje že:

- 1) tento katalóg nepredstavuje ponuku v zmysel občianskeho práva;

- 2) výrobky prezentované v tomto katalógu sa v skutočnosti môžu líšiť od modelov zobrazených na obrázkoch, najmä pokiaľ sa jedná o vonkajšie znaky, t.j. veľkosť, farbu, spôsob balenia, počet predmetov v balení;
- 3) nenesie zodpovednosť za drobné rozdiely v spôsobe balenia či vlastnostiach výrobkov, ktoré nemajú zásadný vplyv na ich určený účel alebo spôsob používania;
- 4) nenesie zodpovednosť vyplývajúcu z akejkoľvek nepresnosti týkajúcej sa informácií uvedených v predmetnom katalógu;
- 5) nenesie zodpovednosť za prípadné škody vzniknuté v dôsledku obdržania tovaru s inými vlastnosťami, než je uvedené na obrázkoch.

II. Aj napriek mimořádnemu úsilíu zo strany firmy TOYA S.A. táto nemôže garantovať, či informácie uvedené v tomto katalógu plne zodpovedajú skutočnosti.

III. Všetky rozhodnutia prijaté na základe informácií uvedených v predmetnom katalógu sú prijímané na vlastné riziko osoby, ktorá tieto informácie využíva.

H

I. A TOYA S.A. tájékoztatja, hogy:

- 1) a jelen katalógus a polgári jog szerinti nem kereskedelmi ajánlat;
 - 2) a jelen katalógusban bemutatott árucikkek a valóságban eltérhetnek a képeken látható mintától, különösen a külső tulajdonságok, mint a méret, szín, csomagolási mód, a csomagban lévő tárgyak száma tekintetében;
 - 3) nem vállal felelősséget a csomagolás módjában vagy az árucikkek olyan tulajdonságaiban történt változtatásokért, amelyek nem befolyásolják lényeges módon annak rendeltetését vagy a felhasználás módját;
 - 4) nem vállal felelősséget a jelen katalógusban lévő információk pontatlanságáért;
 - 5) nem vállal felelősséget azokért az esetleges károkért, amik az árucikkek a fényképeken látható tulajdonságoktól eltérő tulajdonságokkal történő leszállításából erednek.
- II. A TOYA S.A. minden igyekezete ellenére nem tudja garantálni, hogy a jelen katalógusban

található információk teljes egészében megfelelnek a valóságnak.

III. A tárgyi katalógusban található információk alapján meghozott bármilyen döntés annak a személynek a rizikója, aki ezeket az információkat felhasználja.

RO

I. TOYA S.A. informează că:

- 1) prezentul catalog nu constituie ofertă în înțelesul dreptului civil;
- 2) articolele prezentate în prezentul catalog se pot diferi față de mostrele din fotografiile, în special aspectul exterior, adică mărimea, culoarea, modul de ambalare, cantitatea obiectelor în ambalaj;
- 3) nu-și asumă răspunderea referitor la mici diferențe la modul de ambalare sau la articole al căror proprietăți nu au influență referitor la destinația sau modul lor de utilizare;
- 4) nu-și asumă răspunderea referitor la orice inexactitate sau imprecizie, datorită informațiilor cuprinse în catalogul respectiv;
- 5) nu-și asumă răspunderea referitor la o eventuală pagubă ca urmare primirii marfei cu alte proprietăți decât cele prezentate pe fotografii;

II. Cu toate strădanile TOYA S.A., firma nu poate garanta că, informațiile din prezentul catalog corespund realității;

III. Orice decizie preluată în baza informațiilor cuprinse în catalogul respectiv, sunt preluate pe riscul și răspunderea persoanei care a făcut folos de aceste informații.

E

























I. TOYA S.A. comunica lo siguiente:

- 1) el presente catálogo no constituye una oferta, en el sentido que la noción adquiere en la ley civil;
- 2) los artículos presentados en el presente catálogo pueden en realidad diferir de los modelos indicados en las fotografías, especialmente en cuanto a sus propiedades externas, es decir el tamaño, el color, el empaque o la cantidad de los objetos en el empaque;
- 3) la empresa no se hace responsable por pequeñas diferencias en cuanto al empaque o las propiedades de los artículos, siempre y cuando estas diferencias no afectan el propósito o el modo de operación de las herramientas;
- 4) la empresa no se hace responsable por ninguna imprecisión en cuanto a la información presentada en el presente catálogo;
- 5) la empresa no se hace responsable por ningún daño que surja del hecho de que los artículos recibidos difieran de los artículos presentados en las fotografías en cuanto a sus propiedades.

II. A pesar de los mejores intentos de parte TOYA S.A. la empresa no puede garantizar que la información presentada en el presente catálogo corresponda completamente a la realidad.

III. Todas las decisiones tomadas en base a la información presentada en el presente son responsabilidad de la persona que recurra a la dicha información.



	Colour box		Sleeve
	Box with colour label		Carton envelope
	PVC colour box		Bulk
	Box		Plastic holder
	Display colour box		Flag tied on card
	Hanging colour box		Metal box
	Blister card		Metal box with colour label
	Double blister card		Metal box with sleeve
	Double blister transparent		Plastic box
	Half double blister card		Plastic box with colour sleeve
	Sliding card		Plastic case with colour label
	Plastic hanger		Plastic case with label
	Hanging card		Plastic case with colour sleeve
	Header card		Plastic tube with colour label
	Tied on card		Metal clip
	Skin card		Wooden box with sleeve
	Polybag with header card		Pouch
	Polybag		Shrink card / Plastic tray
	Polybag with printed header		
	Polybag with hanger		

FALA linear drains create unlimited possibilities for arranging your bathroom!
 Odpływy liniowe FALA stwarzają nieograniczone możliwości w aranżacji Twojej łazienki!



TOCANTINS

- !5367 -- 30 cm 75371 -- 70 cm
- !5368 -- 40 cm 75372 -- 80 cm
- !5369 -- 50 cm 75373 -- 90 cm
- !5370 -- 60 cm

NAPO

- 75374 – 30 cm 75378 – 70 cm
- 75375 – 40 cm 75379 – 80 cm
- 75376 – 50 cm 75380 – 90 cm
- 75377 – 60 cm

MADEIRA

- 75360 – 30 cm 75364 – 70 cm
- 75361 – 40 cm 75365 – 80 cm
- 75362 – 50 cm 75366 – 90 cm
- 75363 – 60 cm

Special inspection window warrants 100% patency and comfortable cleaning.



SMARTthru

Specjalne okienko rewizyjne to 100% kontroli drożności i wygodne czyszczenie.

Efficient and durable screen prevents siphon trap from clogging up.



STRAINER

Skuteczne i trwałe sito zapobiega zapychaniu syfonu.

Easy cleaning due to a hook included in the delivery.



EASYclean

Łatwe do utrzymania w czystości dzięki dołączonemu haczykowi.

Top-quality precise welded joints warrant drain tightness.



HQwelding

Wysokiej jakości precyzyjne spawy gwarantują szczelność odpływu.

Holders stabilising the body. Additional rigidness through structure supports.



GRIPstrong

Uchwyty stabilizujące korpus. Dodatkowe usztywnienie konstrukcji w podłodze.

Low siphon trap, made of AISI 304 stainless steel, easy to install.



EXTRAslim

Niski syfon wykonany ze stali nierdzewnej AISI 304 ułatwia instalację.

52 mm

Sealing mat included in delivery – necessary in case hydroisolation is to be applied.



HYDRocloth

Mata uszczelniająca w zestawie – niezbędna część przy wykonywaniu hydroizolacji.

Extensive height regulation which enables the drain to be adjusted against the floor level.



EASYfix

Szeroki zakres regulacji wysokości umożliwia dopasowanie odpływu do powierzchni posadzki.





MANUFACTURER / PRODUCENT

TOYA SA
ul. Sołtysowicka 13-15
51-168 Wrocław
☎ (+48 71) 32 46 200
fax: (+48 71) 32 46 370

sales@yato.pl (sale)
export@yato.pl (export)
import@yato.pl (import)

ODDZIAŁ WARSZAWSKI
Teren ProLogis Park Nadarzyn
al. Kasztanowa 160
05-831 Młochów k. Warszawy

☎ (+48 22) 73 82 800
☎ (+48 22) 73 82 828
sales@yato.pl (sale)
export@yato.pl (export)

TOYA ROMANIA SA
Sos. Odăi Nr. 109-123
Sector 1, București
☎ (+40 031) 710 8692
office@yato.ro

YATO TOOLS (SHANGHAI) Co.,Ltd.
No. 8, Lane 1300, East Kangqiao Road
Shanghai, China 201315
☎ (+86 21) 681 829 50
fax: (+86 21) 681 829 51
yato@yato-sh.com

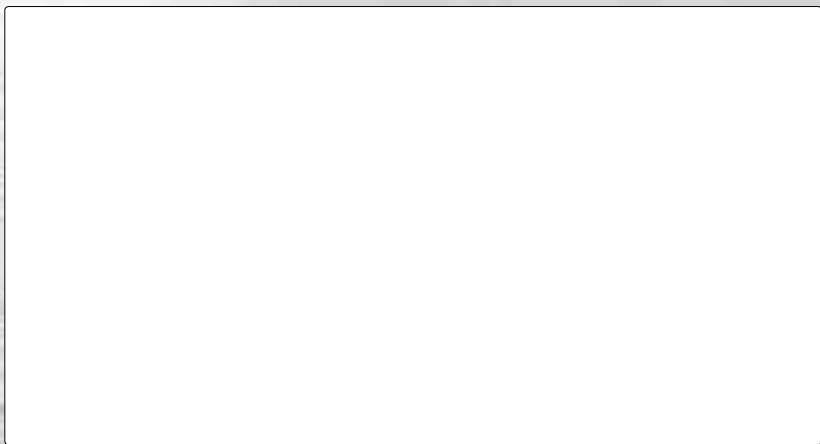

YOUR TRUSTED SUPPLIER / TWÓJ ZAUFANY DOSTAWCA



GET ACQUAINTED WITH OUR WIDE OFFER /
ZOBACZ NASZĄ BOGATĄ OFERTĘ:

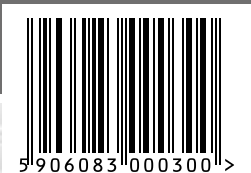

Copyright © TOYA S.A.

www.MagazinulCuScule.ro